

# GhosT-OLED Series

## Manual



Date	Revision No.	Author	1 <sup>st</sup> Check	Final Check	Description
01.12.2016	1.2	BVT/TSN/DWN	TSN	RPA	First Draft

## TABLE OF CONTENT

1.	Important information	4
1.1	Safety instructions	4
1.2	Damage prevention	4
1.3	Operating conditions	5
2.	Overview GhosT-OLED Series	5
2.1	Introduction	5
2.1.1	GhosT-OLED-I (Installation)	6
2.1.2	GhosT-OLED-PT (primeTOUCH)	6
2.2	GhosT-OLED Setup Versions	7
2.2.1	GhosT-OLED Table-Stand Version (TV)	7
2.2.2	GhosT-OLED Straight Version (SV)	7
2.2.3	GhosT-OLED Straight Offset Version (SOV)	8
3.	Scope of delivery	9
4.	Pack-/ and unpack-instructions	10
4.1	Table-Stand Version	10
4.2	Straight Version & Straight Offset Version	12
5.	Installation instructions	14
5.1	Mechanical installation	14
5.1.1	Installations tools and materials	14
5.1.2	Screw hole pattern	15
5.2	Installation possibilities	16
5.2.1	GhosT-OLED Table-Stand Version	16
5.2.2	GhosT-OLED Straight Version	17
5.2.3	GhosT-OLED Straight Offset Version	18
6.	Connector panel and control possibilities	19
6.1	Power Input, IR-Receiver and optional touch	19
6.2	Video input connectors	20
6.3	Local control	21
6.4	External Control Connectors	22
6.4.1	Remote control	23
6.4.2	On-Screen-Display (OSD) menu guide	24
6.4.3	Web interface	25
7.	primeTOUCH option	28
8.	Content Guide	28
8.1	Pixel Shift	28

8.2	Transparency	29
8.3	Static content	29
9.	Troubleshooting	30
10.	Specifications	30
11.	Product outlines	32
11.1	Drawings GhosT-OLED-I	32
11.1.1	Table-Stand Version	32
11.1.2	Straight Version	33
11.1.3	Straight Offset Version	34
11.2	Drawings GhosT-OLED-PT	35
11.2.1	Table-Stand Version	35
11.2.2	Straight Version	36
11.2.3	Straight Offset Version	37
12.	Certification	38

**Note:** These installation instructions must always be handed over to the installing person<sup>1</sup>

**Note:** Read these instructions carefully before installing the system

Copyright © 2016 LANG AG. All rights reserved.

---

<sup>1</sup> Only a qualified person should install this product

## 1. Important information

The GhosT-OLED series has been designed under the highest attention on safety. However, improper handling can cause a risk for safety and/ or damage. Please read carefully the instructions provided in this manual in order to avoid damage and ensure personal safety. Heeding the instructions will also prevent image retention and extend the products lifetime. The GhosT-OLED products are intended for use by fully qualified, trained and competent persons as an aid to provide safe and secure installations.

### 1.1 Safety instructions

- Do not open the housing of the display otherwise electric shocks may occur. There is no need for users to open the housing of the display. Please refer to Lang-AG for any service works.
- Do not expose the screen to water or moisture to prevent electric shocks.
- If the screen or the housing breaks, be very careful as broken fragments may cause injuries. Do not touch broken glass with bare hands, use appropriate safety tools
- If the screen or the housing is broken, always unplug all power supplies and other cables from the display to prevent electric shocks.
- Do not use the system in other operating conditions than described in chapter *1.3 Operating conditions*.
- In cause of injury, for example caused due to contact with broken glass, please seek medical help immediately
- Do not mount the GhosT-OLED displays to unstable structures, the entire system might fall down or tilt over. Make sure that the construction to which a display is mounted can support the given total weight (for weight details please refer to: *10.Specifications*)

### 1.2 Damage prevention

- Do not expose the screen to water or moisture to prevent any damage.
- Avoid any force or impacts on the screen.
- If the screen is broken, always unplug all power supplies and other cables from the display to prevent damage to electronical parts.
- Set up the screen in a well ventilated place.
- The recommended operating time is less than 12 hours a day.
- Static images on the display can cause image retention. To prevent such damage, it is recommended to show dynamic content periodically. Refer to *19. Content recommendations* for furthermore information.
- Do not expose the display to sunlight or any UV light sources as UV light can cause damage to the screen.
- Always operate the system under the specified operating conditions described in chapter *1.3 Operating conditions*.

### 1.3 Operating conditions

- Temperature: 25 +/-10°C
- Humidity: 55 +/-20% rH
- Operating time: less than 12 hours a day
- Display pattern should be changing continuously to avoid any kind of image retention
- No sunlight or any other warm light sources directed onto the screen
- Only indoor operation
- Display must be protected from UV light
- Usage only in well ventilated environments

## 2. Overview GhosT-OLED Series

### 2.1 Introduction

Displays from GhosT-OLED series are transparent OLED (T-OLED) screens in Full-HD resolution with low temperature poly silicon TFTs. The transmittance of the screen is approx. 45% (excluding cover glass). Thanks to OLED (Organic Light Emitting Diode) technology, the display shows excellent images even at high viewing angles and has very low power consumption. The transparency is achieved by adding a fourth segment into the sub pixel structure which usually consists of three sub pixel emitting red, green and blue light. This fourth segment is transparent and compared to the other sub pixel the largest one. As OLED is a self-emitting technology, there is, unlike to LCDs, no need for backlight. Displaying black content on a transparent OLED display will make this content appear transparent. GhosT-OLED displays are bonded with an anti-reflective, tempered front glass and are optionally available with a primeTOUCH system based on IR diodes. GhosT-OLED displays can be delivered with white or black housing.

The GhosT-OLED series is based on a customizable design concept. There are two different versions available, each with three variable ways to install them. With this portfolio GhosT-OLED Series offers a standard solution for many applications.

### 2.1.1 GhosT-OLED-I (Installation)

This version provides a frameless glass surface, thinner than 9 mm. With its frameless but robust design the GhosT-OLED-I version is perfect for exclusive, futuristic installations. The display is available in each of the three installation options whereby the Table-Stand Version is pictured below.



**Figure 1: GhosT-OLED-I, TV Option**

### 2.1.2 GhosT-OLED-PT (primeTOUCH)

This version combines the advantages of the T-OLED technology with the multi touch capable primeTOUCH technology. Despite touch capability it provides a narrow but stable frame. The display is available in each of the three installation options whereby the Table-Stand Version is pictured below.



**Figure 2: GhosT-OLED-PT, TV Option**

## 2.2 GhosT-OLED Setup Versions

The three different setup versions for GhosT-OLED-I and -PT will be described briefly in the following passage. Please note: All images present the GhosT-OLED-I, but basically the same applies also to GhosT-OLED-PT.

### 2.2.1 GhosT-OLED Table-Stand Version (TV)

For flexible use and fast setup the Table-Stand Version is recommended. Mounting points on the bottom side of the display enable portrait mode, face up installations and setups to angled surfaces. The design of the table foot allows convex display arrays with angles up to 90°.



Figure 3: GhosT-OLED-I, TV Option, backside

### 2.2.2 GhosT-OLED Straight Version (SV)

The Straight Version is designed for space-saving installations like in podiums, balustrades or counters. It's quick and easy to install by using the mounting points in the front.



Figure 4: GhosT-OLED-I, SV Option, backside

### 2.2.3 GhostT-OLED Straight Offset Version (SOV)

The straight-offset version provides all the advantages of the Straight Version with an additional mounting surface for leveled installations. It uses the same mounting points as the Straight Version.



**Figure 5: GhosT-OLED-I, SOV Option, backside**









### 3. Scope of delivery

**Note:** Please check the delivery for completeness and damage immediately after you receive the shipment. Please contact your supplier in case of missing or damaged parts.

GhosT-OLED-I delivery scope	
Quantity	Item
1	GhosT-OLED-I
1	Power cable
1	Remote control
1	External IR-Receiver
1	USB stick (tools & info)

GhosT-OLED-PT delivery scope	
Quantity	Item
1	GhosT-OLED-PT
1	Power cable
1	Remote control
1	External IR-Receiver
1	USB stick (tools & info)
1	USB cable (A type)
1	USB extender (A type)

Power cable 	USB cable 	USB extender 
External IR-sensor 	Remote control 	USB stick 

Illustrated list of mentioned accessories

#### 4. Pack-/ and unpack-instructions

GhostT-OLED units get shipped in a functional flight case designed for all three installation versions. Caused by the universality the units get inserted upside down.

**Note:** Read the following instructions carefully to prevent injuries to humans or damages to the system and environment.

**Note:** GhostT-OLEDs provided as straight-/ or straight-offset version have to be mounted right after unpacking. There is no possibility to place them on a table or on the floor intermediately.

**Note:** For packing and unpacking a unit at least two persons are required.

##### 4.1 Table-Stand Version

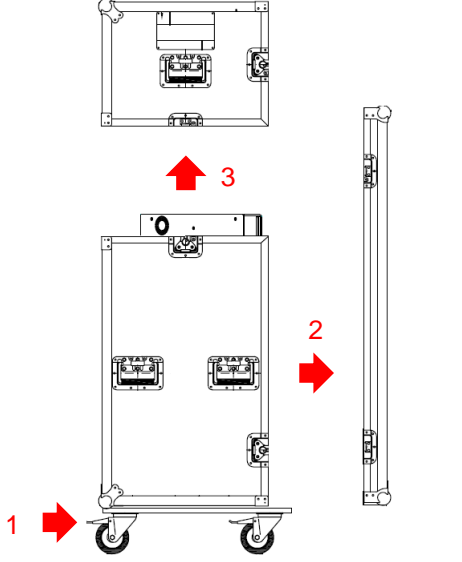
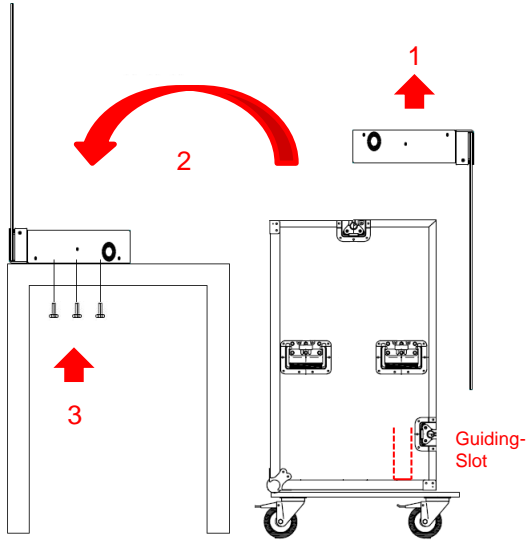
Description	Illustration
<ol style="list-style-type: none"> <li>1. Make sure that the brakes of the flight case are tightened</li> <li>2. Open the front cover of the flight case</li> <li>3. Open the top cover of the flight case</li> </ol>	
<ol style="list-style-type: none"> <li>1. Lift the unit out of the flight case carefully by considering the guiding slot on the bottom side of the flight case</li> <li>2. Rotate the unit by 180° degrees and set it down carefully</li> <li>3. Attach the display to the exhibition furniture referring to 5 <i>Installation instruction</i></li> </ol>	

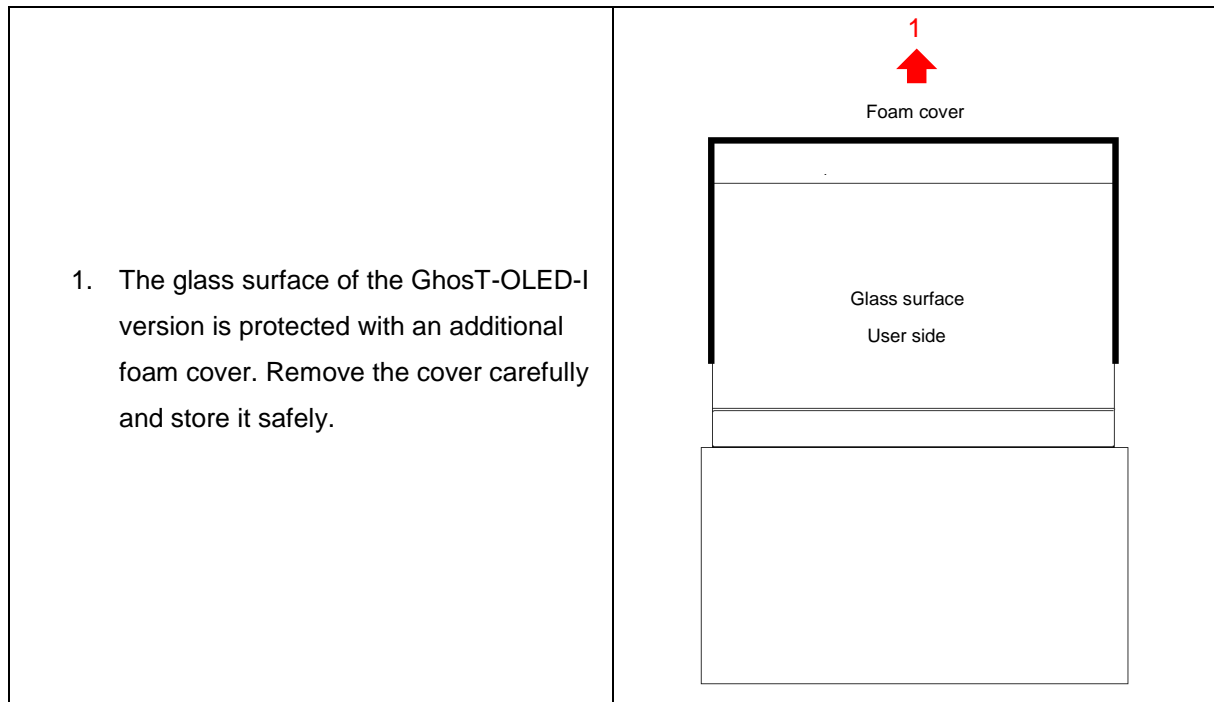

**Note:** For packing follow the provided steps backwards

## 4.2 Straight Version & Straight Offset Version

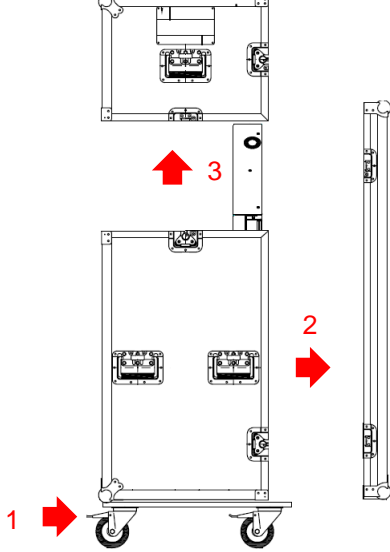
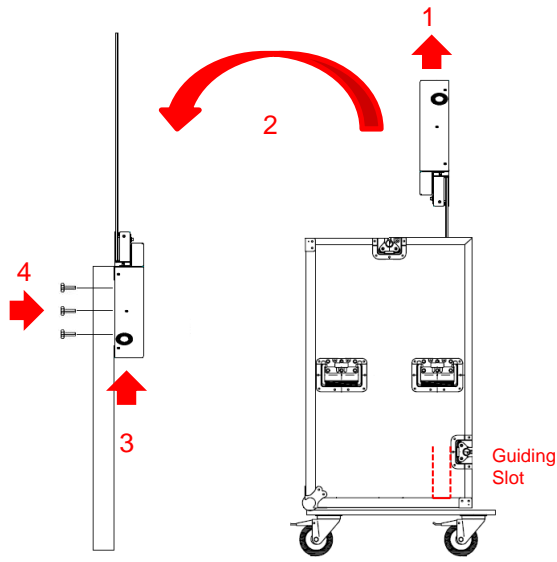
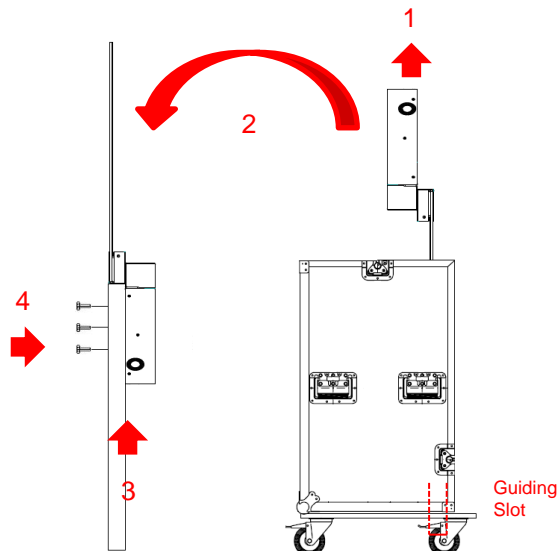
Description	Illustration
<ol style="list-style-type: none"> <li>1. Make sure that the brakes of the flight case are tightened</li> <li>2. Open the front cover of the flight case</li> <li>3. Open the top cover of the flight case</li> </ol>	
<p><b>Straight Version</b></p> <ol style="list-style-type: none"> <li>1. Lift the unit out of the flight case carefully by considering the guiding slot on the bottom side of the flight case</li> <li>2. Rotate the unit by 180° degrees</li> <li>3. Align the unit to the construction of the exhibition furniture carefully</li> <li>4. Attach the unit to the exhibition furniture referring to 5 <i>Installation instruction</i></li> </ol>	
<p><b>Straight Offset Version</b></p> <ol style="list-style-type: none"> <li>1. Lift the unit out of the flight case carefully by considering the guiding slot on the bottom side of the flight case</li> <li>2. Rotate the unit by 180° degrees</li> <li>3. Align the unit to the construction of the exhibition furniture by using the angled mounting surface</li> <li>4. Attach the unit to the exhibition furniture referring to 5 <i>Installation instruction</i></li> </ol>	

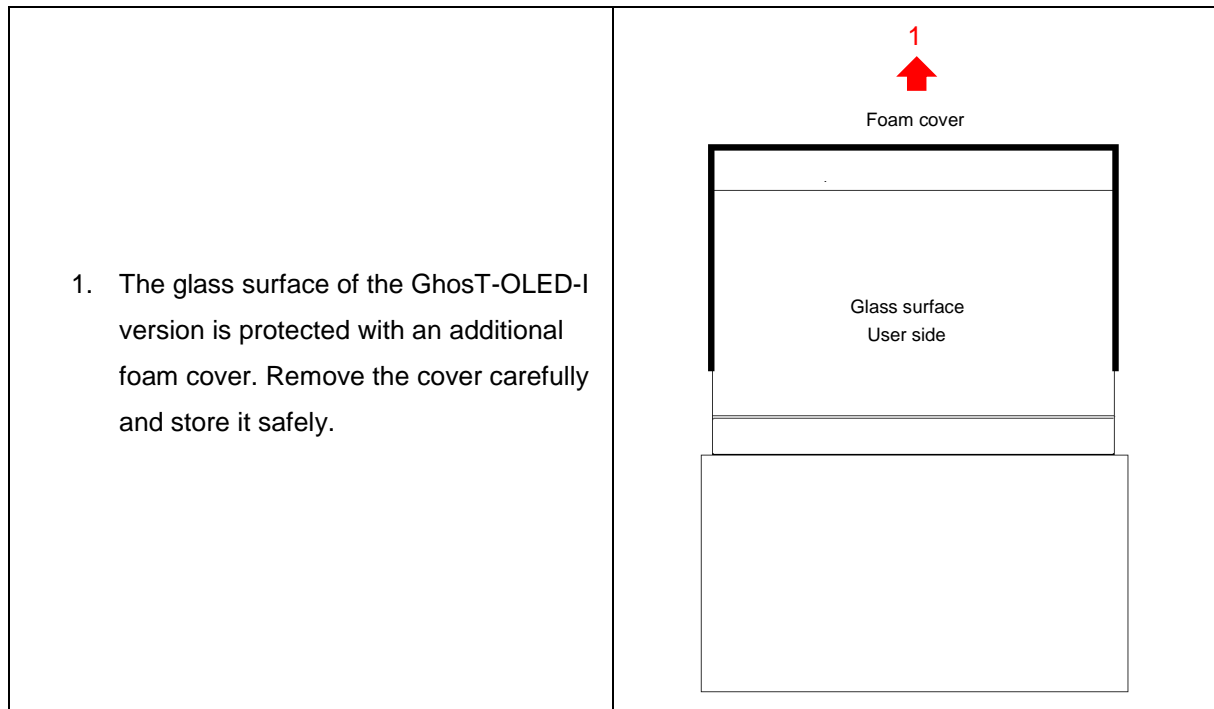

**Note:** For packing follow the provided steps backwards.

## 5. Installation instructions

### 5.1 Mechanical installation



All versions of the Ghost-OLED series are based on the same housing system which makes them easy and fast to setup. Before you start installing the screen, follow the instructions provided in 3 *Scope of delivery* and 4 *Pack-/ and unpack-instructions*.

**Note:** Read the following instructions carefully to prevent injuries to humans or damages to the system.

**Note:** For mounting the Ghost-OLED at least three persons are required.

**Note:** Use only the required tools and mounting materials.

#### 5.1.1 Installations tools and materials

Quantity	Description	Illustration
1	<ul style="list-style-type: none"> <li>5mm HEX key</li> </ul>	
up to 14	<ul style="list-style-type: none"> <li>M6 x 16 mm + surface thickness</li> </ul> <ul style="list-style-type: none"> <li>➤ <b>Note:</b> The screw size always needs to be 16 mm longer than the surface thickness of the exhibition furniture.</li> <li>➤ <b>Note:</b> The head shape of the screw depends on the conditions of the mounting area.</li> <li>➤ <b>Note:</b> The number of available screw holes depends on the given version and installation option.</li> <li>➤ <b>Note:</b> Min. 8 screw holes have to be used</li> </ul>	
up to 14	<ul style="list-style-type: none"> <li>6,4 mm washers</li> </ul> <p><b>Note:</b> The use of safety washers is recommended in most cases. This depends on the material of the mounting area</p>	

### 5.1.2 Screw hole pattern

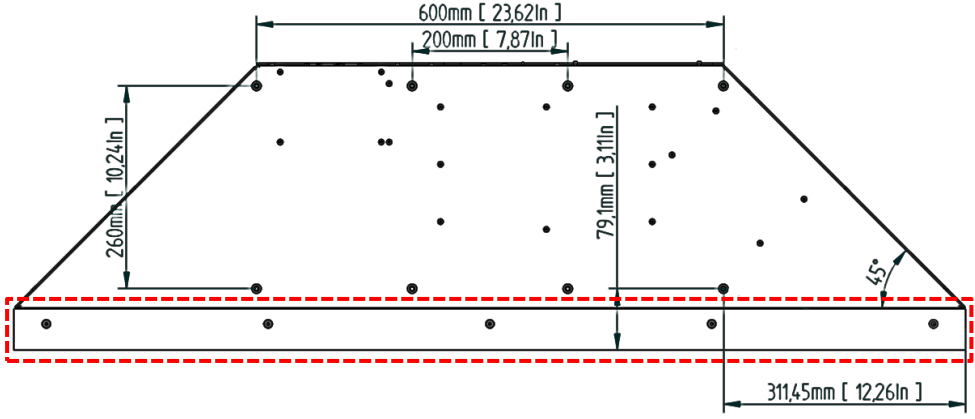
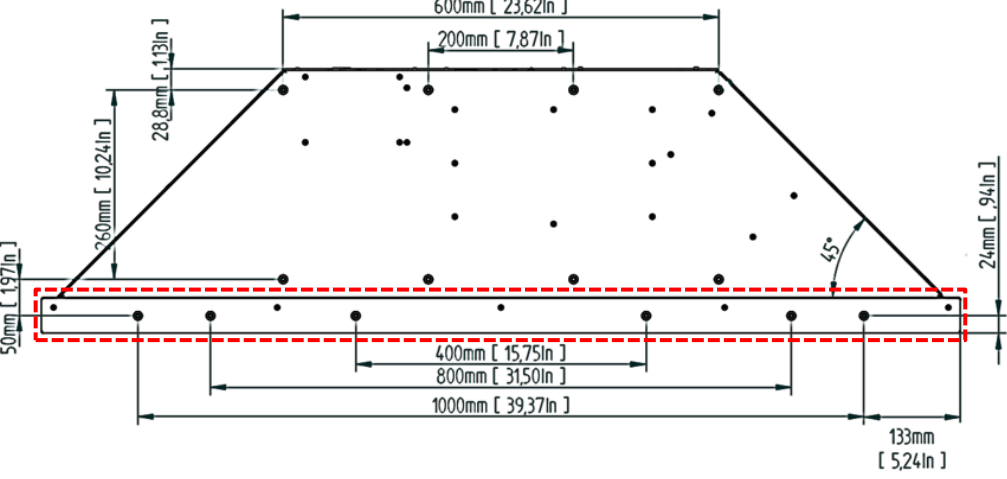
Version	Screw hole pattern in mm [In]
GhosT-OLED-I	 <p><b>Note:</b> The red marked area cannot be used.</p>
GhosT-OLED-PT	 <p><b>Note:</b> The red marked area is only available in case of using the Table-Stand Version</p>

## 5.2 Installation possibilities

### 5.2.1 GhosT-OLED Table-Stand Version

Set up on leveled surfaces, the GhosT-OLED TV option is able to run without additional mounting, but it's recommended to mount at least 4 screws to the exhibition furniture to hold the unit in place. It's also made for angled surfaces or portrait mode applications. Therefore the Table-Stand Version provides min. 8 mounting points on the bottom side of the table foot. The length of the screw depends on the surfaces thickness. Please refer to 5.1.1 Installations tools and material.

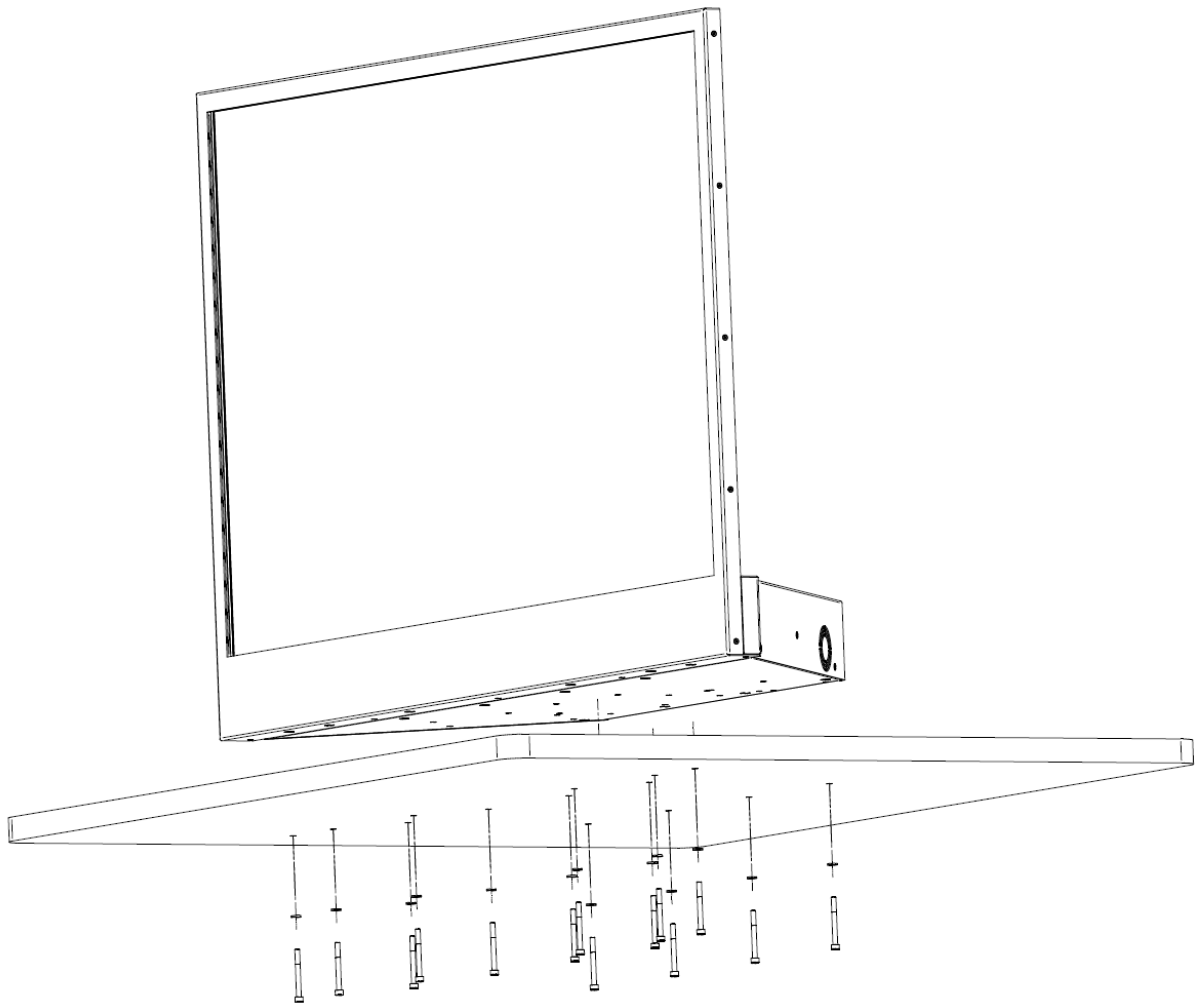
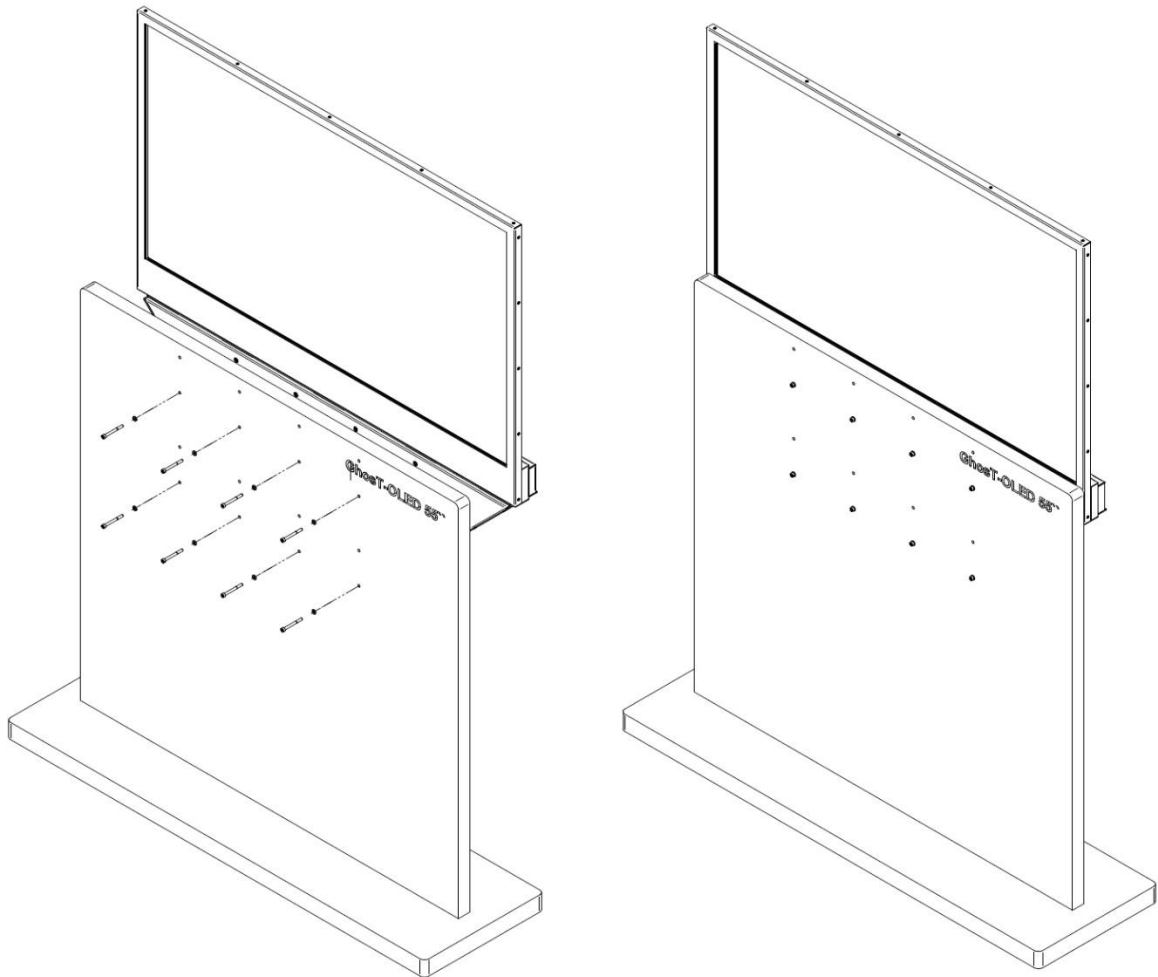

**Figure 6: Installation example GhosT-OLED-PT TV Option**



## 5.2.2 GhosT-OLED Straight Version

The GhosT-OLED Straight Version can only be mounted correctly by using all of the provided mounting points. Therefore it's required to work in a team of at least three persons. Two persons are needed to align the display to the screw-hole pattern while the third person can insert the screws into the mounting points.



**Figure 7: Installation example GhosT-OLED-PT SV Option**

### 5.2.3 Ghost-OLED Straight Offset Version

The Ghost-OLED Straight Offset Version can only be mounted correctly by using all of the provided mounting points. Therefore it's required to work in a team of at least three persons. Two persons are needed to align the display to the screw-hole pattern while the third person can insert the screws into the mounting points. This version has the advantage that it's possible to load the weight to the angled mounting surface while installing.

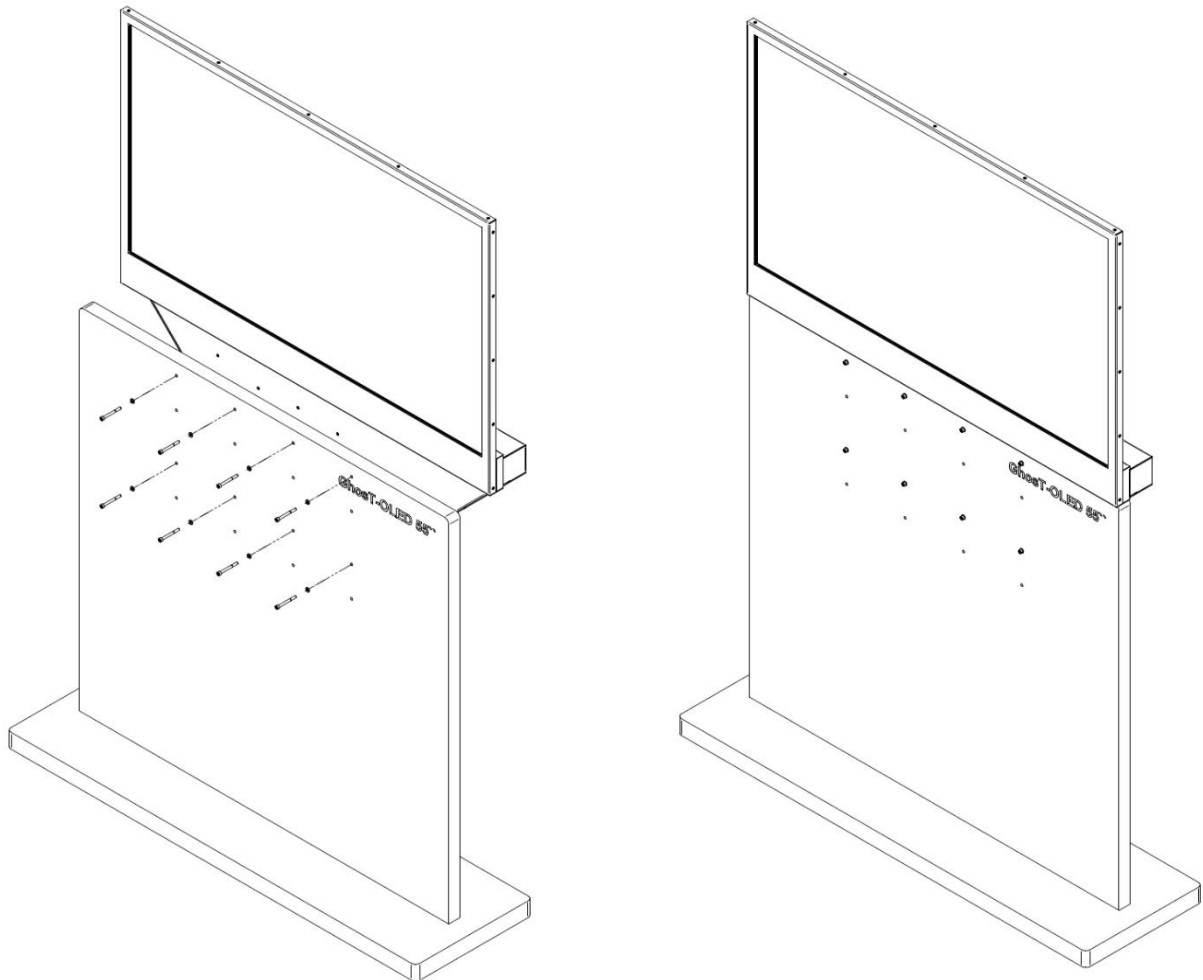

**Figure 8: Installation example Ghost-OLED-PT SOV Option**

## 6. Connector panel and control possibilities

All versions share a similar connector panel on the backside of the table foot.

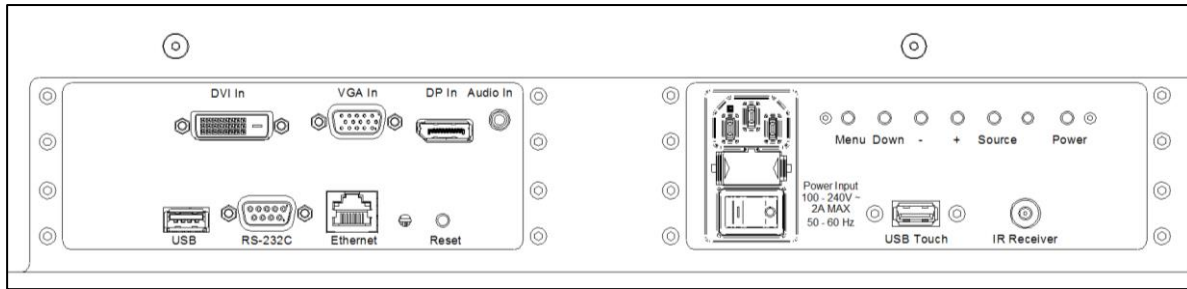
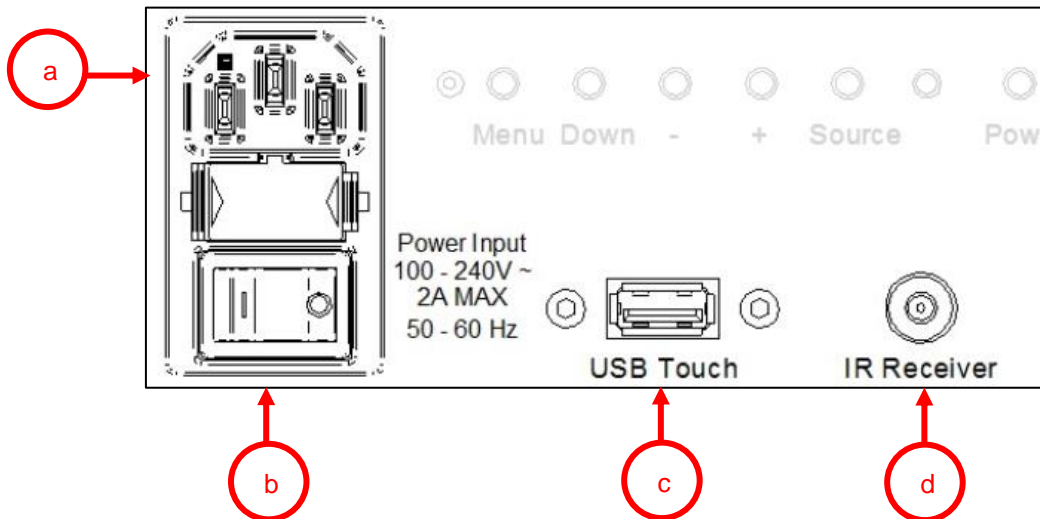
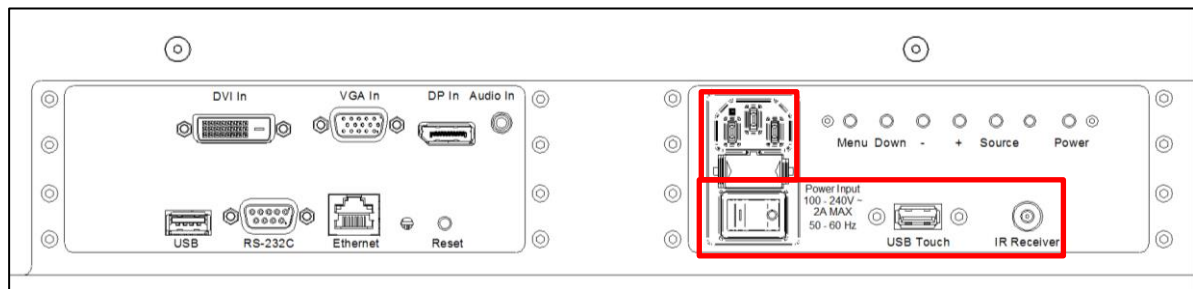

Figure 9: GhostT-OLED connector panel

### 6.1 Power Input, IR-Receiver and optional touch

These components are located at the lower right side of the connector panel like shown below:



	Description	technical design
a	AC IN connector	IEC socket
b	Main Power switch	2 pin rocker switch
c	primeTOUCH USB (optional)	USB type A, female
d	External IR-receiver input	3,5 mm jack, female

## 6.2 Video input connectors

The GhostT-OLED provides three different video input connectors. All of them are located at the upper left side of the connector panel like shown below: The native input timing for the GhostT-OLED series is 1920 by 1080 @60p. The display will accept other timings as well and most likely display them, but the results might not be sufficient. The panel will always work with 60p refresh rate even if the input frame rate might be different.

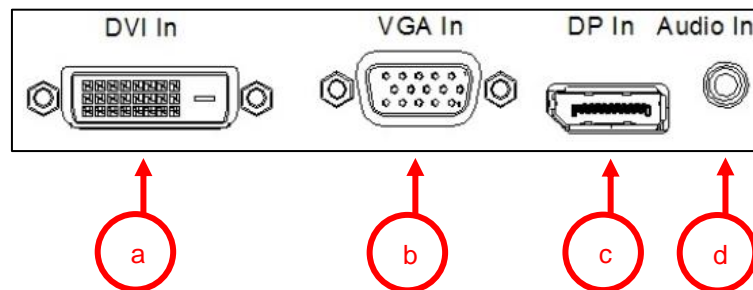
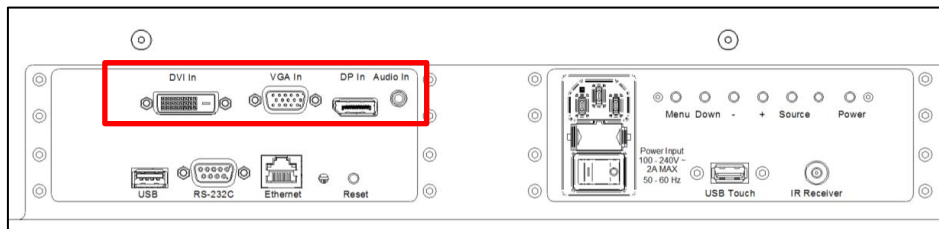

	Description	technical design
a	DVI connector	DVI-D, female
b	VGA IN	Mini D-sub, 15 pin, female
c	DISPLAYPORT connector	DISPLAYPORT, female
d	Audio input <b>Note:</b> cannot be used	No function

### 6.3 Local control

The GhosT-OLED series provides a user-friendly keyboard which is located at the upper right side of the connector panel like shown below:

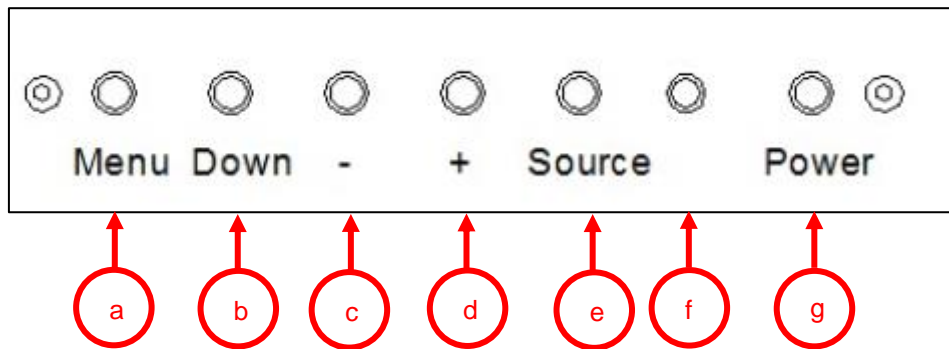
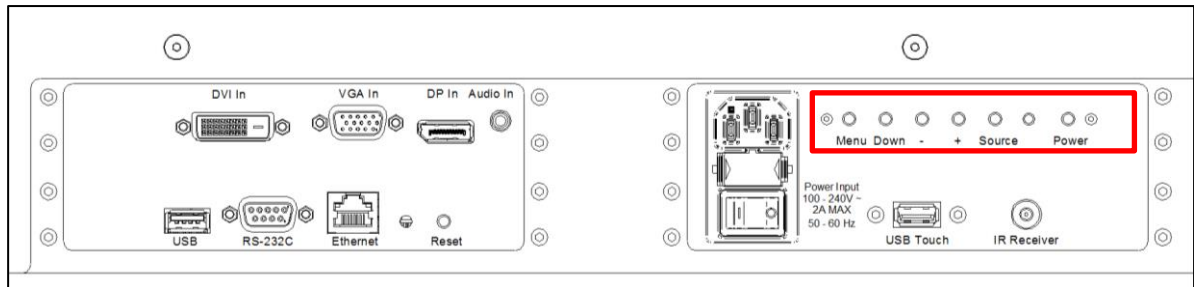

	Description	technical design
a	Menu button	Short travel key switch
b	Down button	Short travel key switch
c	Decrease button	Short travel key switch
d	Increase button	Short travel key switch
e	Source button	Short travel key switch
f	Status LED	G/O/R, leaded LED
g	Power button	Short travel key switch

## 6.4 External Control Connectors

The GhostT-OLED series provides an option for external control that is located at the lower left side of the connector panel like shown below:

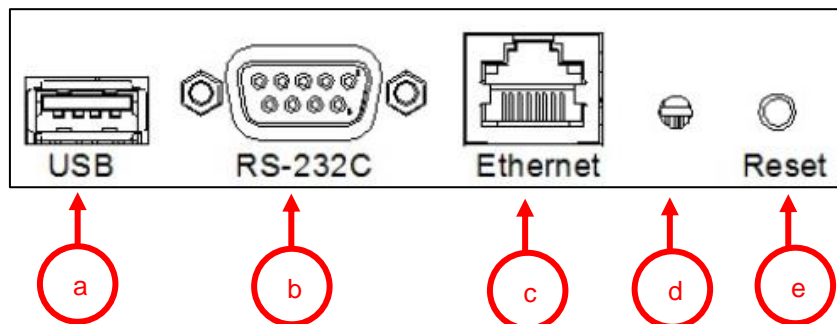
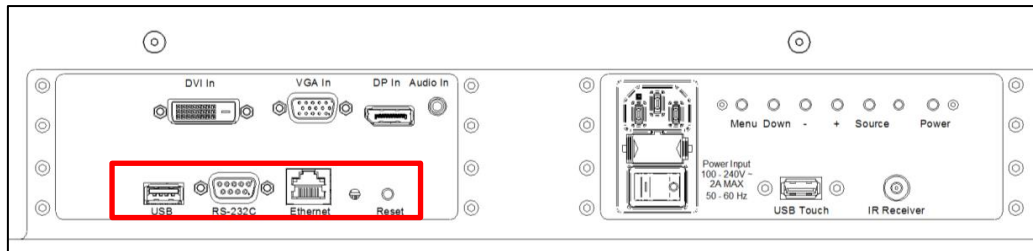

	Description	technical design
a	USB connector <b>Note:</b> for service access only	USB type A, female
b	RS-232C connector	D-sub, 9 pin, female
c	LAN port	RJ45, female
d	Status LED	G, leaded LED
e	Reset Button	Short travel key switch

For controlling the GhostT-OLED via Network use the LAN port provided as RJ-45 socket. The default IP-address of the GhostT-OLED is 192.168.0.xyz whereby xyz changes depending on the unit you are using. The complete IP-address including network- and host-part is labeled at the connector panel on the backside of your GhostT-OLED. If you want to change the IP-address to adapt it to your network please refer to [6.4.3 Web interface](#).

### 6.4.1 Remote control

All units are shipped including a remote control like described in 3 *Scope of delivery*. The important functions that are required to set up a GhostT-OLED are explained below. All other buttons have no function.

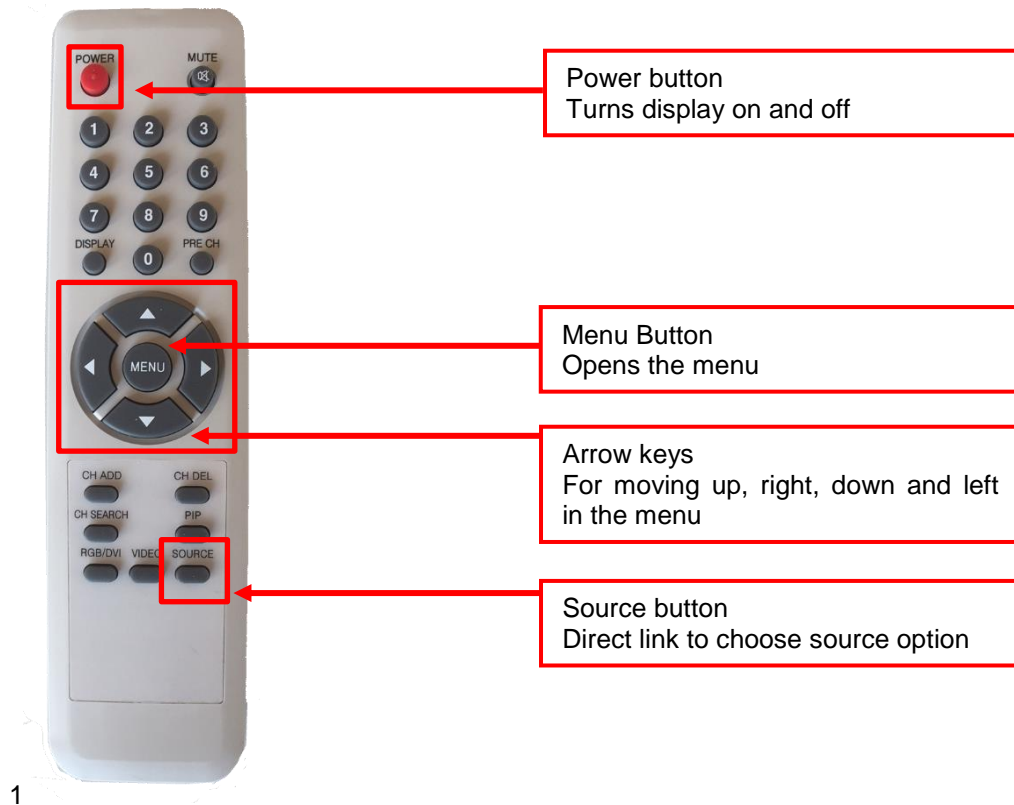

## 6.4.2 On-Screen-Display (OSD) menu guide

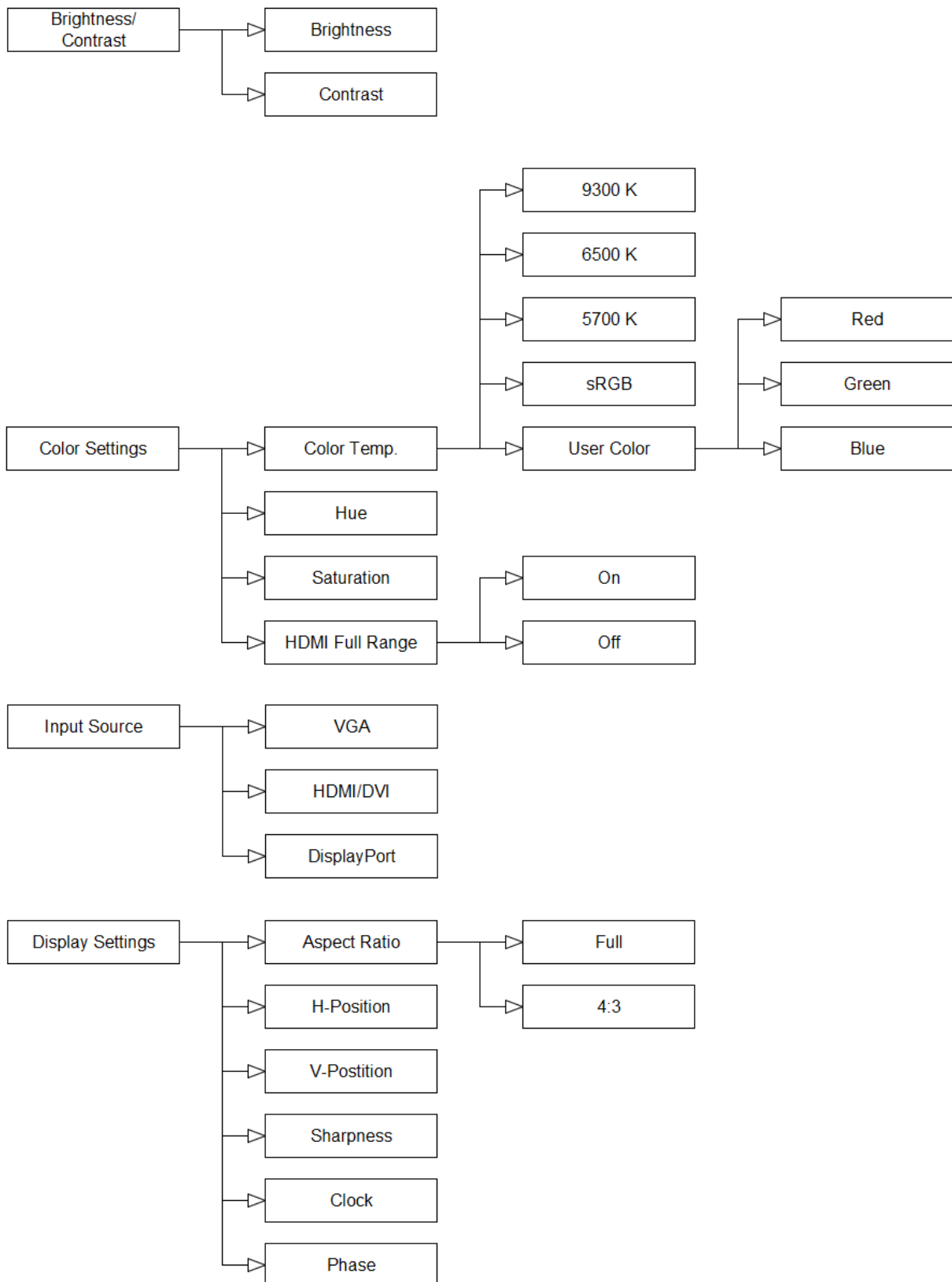



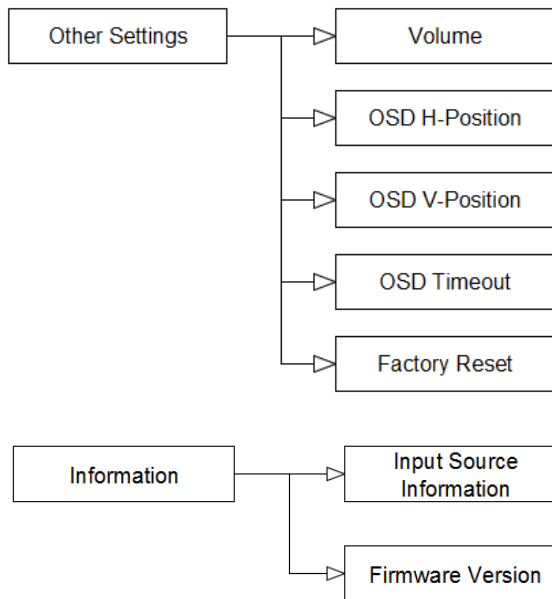

Note: These menu items are not adjustable

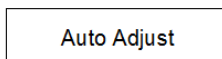

Note: This function is only activated when using VGA

### 6.4.3 Web interface

All displays of Ghost-OLED series can be controlled by an easy operable web interface which provides several capturing and controlling options.

To access the web interface please follow the steps below.

- Step 1:** Connect the Ghost-OLED to your PC by using the LAN port on the connector panel.
- Step 2:** Make sure that both devices are within the same network by setting the PCs ip-address to 192.168.0.xyz (subnet mask 255.255.255.0) whereby xyz can be a number between 2 and 254 except the last number of the Ghost-OLEDs ip-address.
- Step 3:** Access the web interface by typing in the Ghost-OLEDs ip-address to the URL window of your web browser.
- Step 4:** The pictured overview window will appear (Figure 10). If not try to disable your firewall and try again.
- Step 5:** If you now click on one of the submenus you will be requested to type in the following username and password to continue:

- Username: admin
- Password: 1234

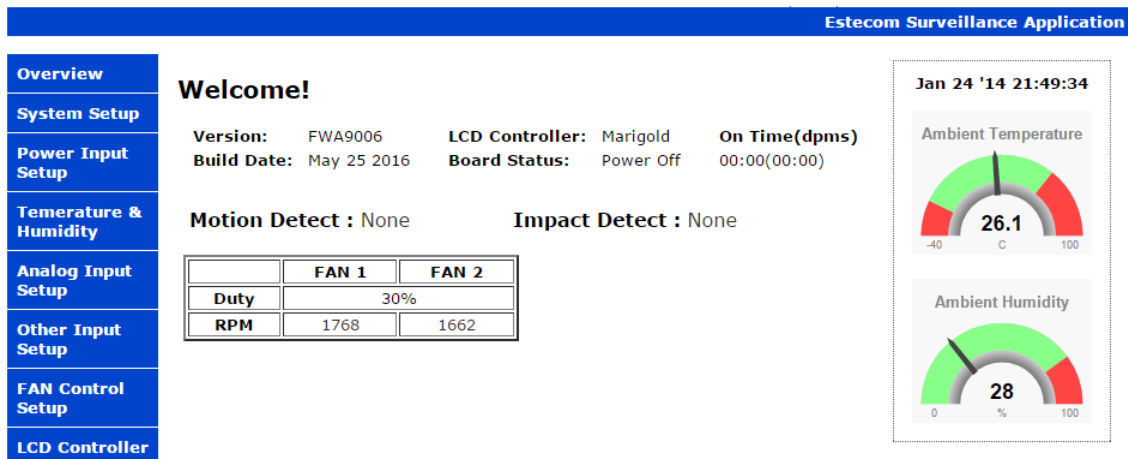

**Figure 10: Web interface - welcome screen**

To change the ip-address of your GhosT-OLED and adapt it to your network please follow the steps below.

**Warning:** Adjustments on the GhosT-OLEDs ip-address should only be carried out by a qualified person.

**Step 1:** Go to the submenu *System Setup* and disable the checkmark on *Enable DHCP* (Figure 11).

**Step 2:** Suit the *IP Address*, *Gateway* and *Subnet Mask* to your network structure and click on *Save Setup* (Figure 11) and await the system reboot.

**Note** that from now on you can only reach the web interface by the GhosT-OLEDs new ip-address.

Estecom Surveillance Application

[Overview](#)  
[System Setup](#)  
[Power Input Setup](#)  
[Temperature & Humidity](#)  
[Analog Input Setup](#)  
[Other Input Setup](#)  
[FAN Control Setup](#)  
[LCD Controller](#)

### System Setup

[ Network Configuration ] [ E-mail Configuration ] [ SNMP Manager ] [ Password ] [ Time ]

**Network Configuration**

MAC Address:

Host Name:

Enable DHCP

IP Address:

Gateway:

Subnet Mask:

Primary DNS:

Secondary DNS:

**Figure 11: System Setup**

To remote control your GhosT-OLED via web interface please follow the steps below.

- Step 1:** Go to submenu *LCD Controller* and make sure that *Marigold* is selected as board type (Figure 12).  
 Otherwise select *Marigold* and click on *Change Board Type* (Figure 12) to continue.
- Step 2:** Now you can remote control your GhosT-OLED by using the provided buttons and options (Figure 12).

Estecom Surveillance Application

[Overview](#)  
[System Setup](#)  
[Power Input Setup](#)  
[Temperature & Humidity](#)  
[Analog Input Setup](#)  
[Other Input Setup](#)  
[FAN Control Setup](#)  
[LCD Controller](#)

### Monitor Control Processing

This is for Marigold board. [Change Board Type](#)

---

**Light Sensor**

**Brightness**

**Contrast**

**Source**

**Power**

OSD Key

**Figure 12: LCD Controller**

## 7. primeTOUCH option

As HID (human interface device) the primeTOUCH is a plug and play capable system. For advanced features like calibrating the touch coordinates to the image or running a diagnose of the system you need to install a special software. It is called “Multi Touch Platform” and it is provided on an USB stick that comes with every GhostT-OLED unit. Besides that the USB stick contains a detailed manual for the primeTOUCH function and additional documentation. The software and documentation can also be downloaded from [www.prime-touch.com](http://www.prime-touch.com).

**Note:** It’s necessary to run a calibration process every time you connect the GhostT-OLED-PT with a new PC or Mac.

## 8. Content Guide

### 8.1 Pixel Shift

The GhostT-OLED is running with an integrated pixel shift to avoid image retention. This function shifts the shown image spirally in intervals of 30 seconds. The maximum offset during shifting image is about 16 pixels. This leads to the fact that content will partly be shifted out of the active screen area and not be shown. Also there will be parts of the active screen area that will not show content. In case of using the T-OLED together with a touch input device, calibration will not remain precise all the time.

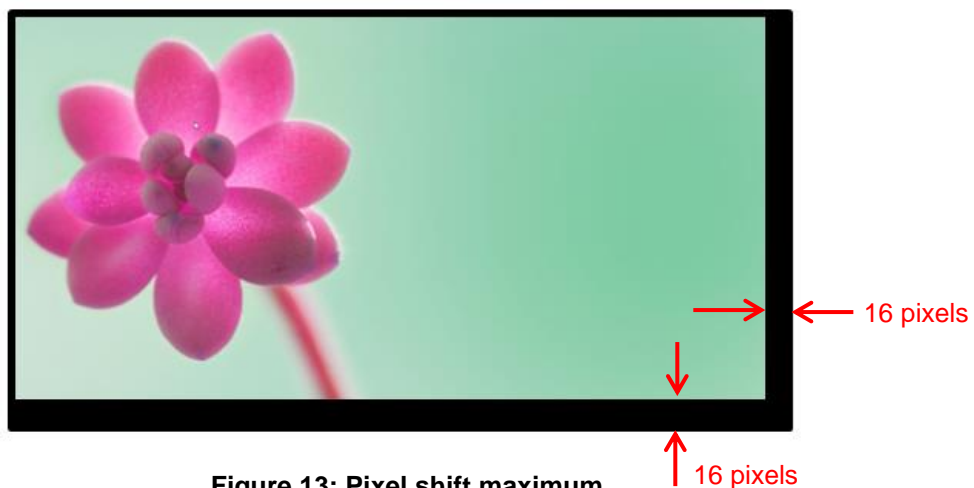

**Figure 13: Pixel shift maximum**

It is possible to deactivate the pixel shift function in the menu. Please refer to 6.4.2 On-Screen-Display (OSD) menu guide.

**Note:** It is highly recommended to activate the Pixel shift. Deactivating the pixel shift function can cause permanent burn-in effects in the panel. Deactivate only in controlled environments where the content can’t be switched to static.

**Note:** If you are designing interactive content consider the pixel shift functionality. For example buttons should have an adequate size.

## 8.2 Transparency

Black colored content parts will appear transparent so it's recommended to provide as much black parts as possible during content design to highlight the panel transparency. Such content will also minimize image retention. To conceal the pixel shift it is recommended to have more than 16 black pixels on the image boarder. (Figure 14)



**Figure 14: Content + 16 black pixel border**

## 8.3 Static content

Moving content is more suitable than static content. If static images are necessary it's recommended to display moving images between the static images. Furthermore static images should not be displayed more than 30 seconds because this can cause image retention and a reduction of lifetime.

Logos or letterings embedded to your content must also not be displayed more than 30 sec even if the remaining content is moving. If such logos or letterings are necessary it's recommended to rotate them in intervals smaller than 30 seconds as well. (Figure 15)



**Figure 15: Rotation of logos or letterings**

## 9. Troubleshooting

	Description of error	Potential cause	Potential solutions
1	No picture is shown	<ul style="list-style-type: none"> <li>- Power is turned of</li> <li>- Faulty cables or adapters</li> <li>- Wrong source</li> </ul>	<ul style="list-style-type: none"> <li>- Check power switch</li> <li>- Check cabling and adapters</li> <li>- Check if correct source is chosen</li> </ul>
2	Picture disappears periodically after a few seconds	<ul style="list-style-type: none"> <li>- Display is rebooting periodically</li> </ul>	<ul style="list-style-type: none"> <li>- Check power supply, mains adaptor could be damaged</li> <li>- Check image signal, resolution may change periodically</li> </ul>
3	Beeping noise sounds	<ul style="list-style-type: none"> <li>- Fan is blocked</li> </ul>	<ul style="list-style-type: none"> <li>- Check fans, one of them might be blocked</li> </ul>
4	No touch function	<ul style="list-style-type: none"> <li>- Faulty USB cable</li> <li>- Faulty USB extension</li> </ul>	<ul style="list-style-type: none"> <li>- Check cabling</li> <li>- Check if passive USB extender is too large or damaged</li> </ul>
5	False touch function	<ul style="list-style-type: none"> <li>- Driver is not installed</li> <li>- Not calibrated</li> </ul>	<ul style="list-style-type: none"> <li>- Check if driver is installed correctly</li> <li>- Calibrate device (refer to 7 <i>primeTOUCH option</i>)</li> </ul>

Please contact support if none of the solutions is working: [ghost-oled@lang-ag.com](mailto:ghost-oled@lang-ag.com)

## 10. Specifications

Item	Specification	Unit	Note
<b>Display</b>			
<b>Resolution</b>	1920 x 1080	Pixel	
<b>Aspect Ratio</b>	16/9		
<b>Display Area</b>	1209.6 x 680.4 [Diagonal: 55"]	mm [inch]	
<b>Luminance of White</b>	Peak 1%: 500 Full White: 150	cd/m <sup>2</sup>	Typical (1)
<b>Transmittance</b>	45%		Typical (1)
<b>Display Colours</b>	1,07Billion		
<b>Orientation</b>	Landscape/Portrait		
<b>Options</b>	Table Version (by default) Straight Version (2) Straight Offset Version (2)		

Connectivity and Control			
<b>Input</b>	1 x DisplayPort 1 x DVI-D 1 x VGA	(Digital) (Digital) (Analog)	
<b>External Control</b>	Ethernet (Web Interface) RS-232C		
<b>Remote Control</b>	IR Remote		With external IR receiver
<b>Local Control</b>	Keyboard		On back side
Physical Specification			
<b>Dimensions</b>		mm	See: 11. Product outlines
<b>Weight</b>			
GhosT-OLED-I	42	kg	
GhosT-OLED-PT	35		
Electrical			
<b>Power Consumption</b>	100 - 240 V~ / 2A MAX / 50 - 60 Hz		
Environmental Conditions			
<b>Storage Temperature</b>	Min: 5 Max: 40	°C	
<b>Operating Temp.</b>	Normal: 25 +/- 10	°C	
<b>Storage Humidity</b>	Min: 35 Max: 75	%rH	
<b>Operating Humidity</b>	Normal: 55 +/- 20	%rH	
Lifetime			
<b>Operating Lifetime</b>	30.000	Hour	(3)
primeTOUCH Options			
<b>Touch Points</b>	6 / 12 / 32 / 50	Simultaneous touch points	
<b>Connection</b>	USB A Female		
Certifications			
<b>Product Approvals</b>	CE / FCC		

Note (1) might vary depending on front glass

Note (2) on request

Note (3) Operating Lifetime is defined as the time until the brightness is reduced to 50% of its original value and can only be guaranteed under recommended operating conditions.





### 11.1.2 Straight Version

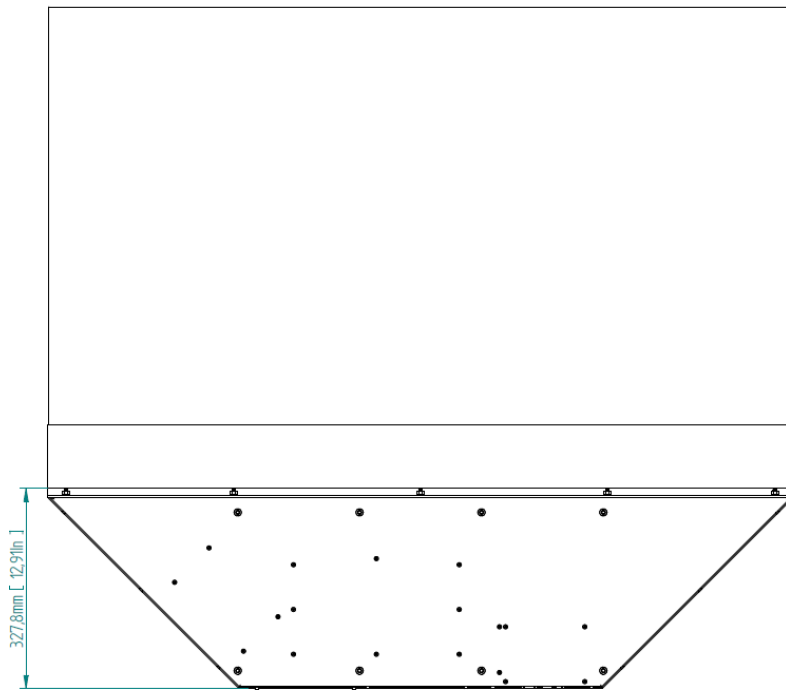

Figure 17: GhostT-OLED-I SV Option, front view

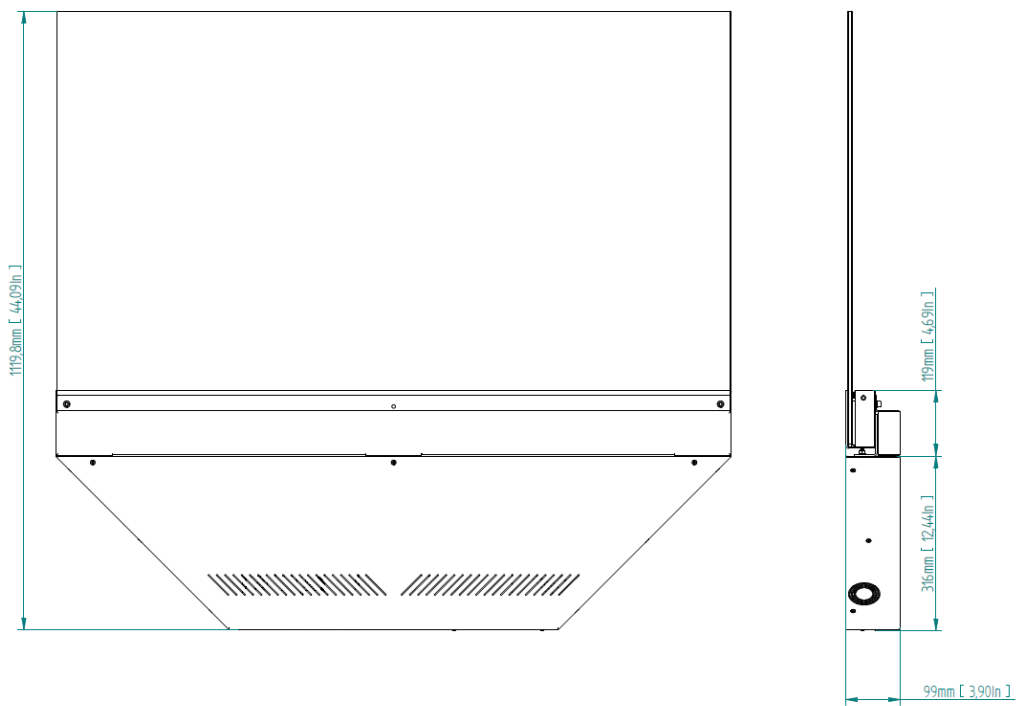

Figure 18: GhostT-OLED-I SV Option, back, side view

### 11.1.3 Straight Offset Version

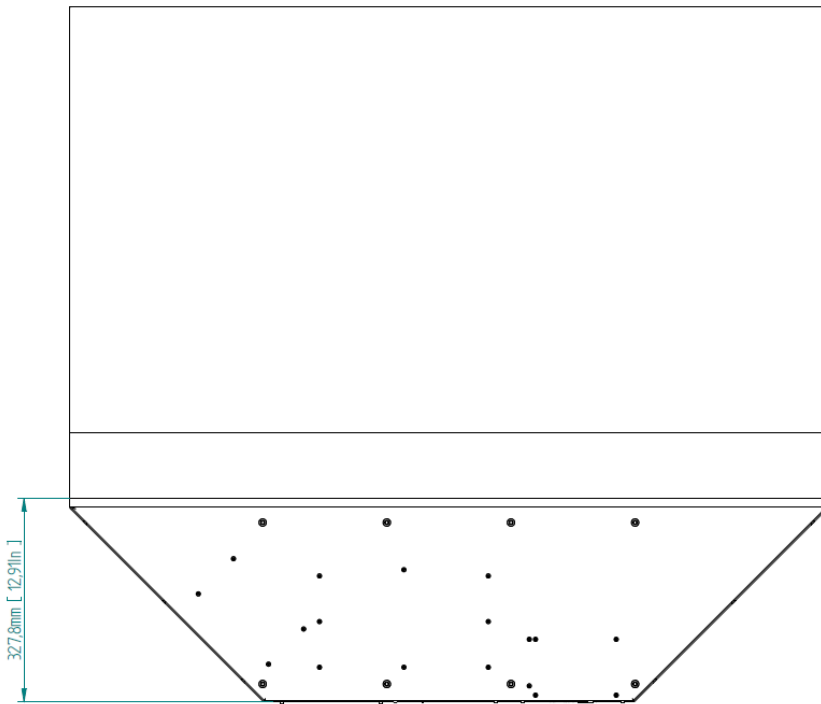

Figure 19: GhostT-OLED-I SOV Option, front view

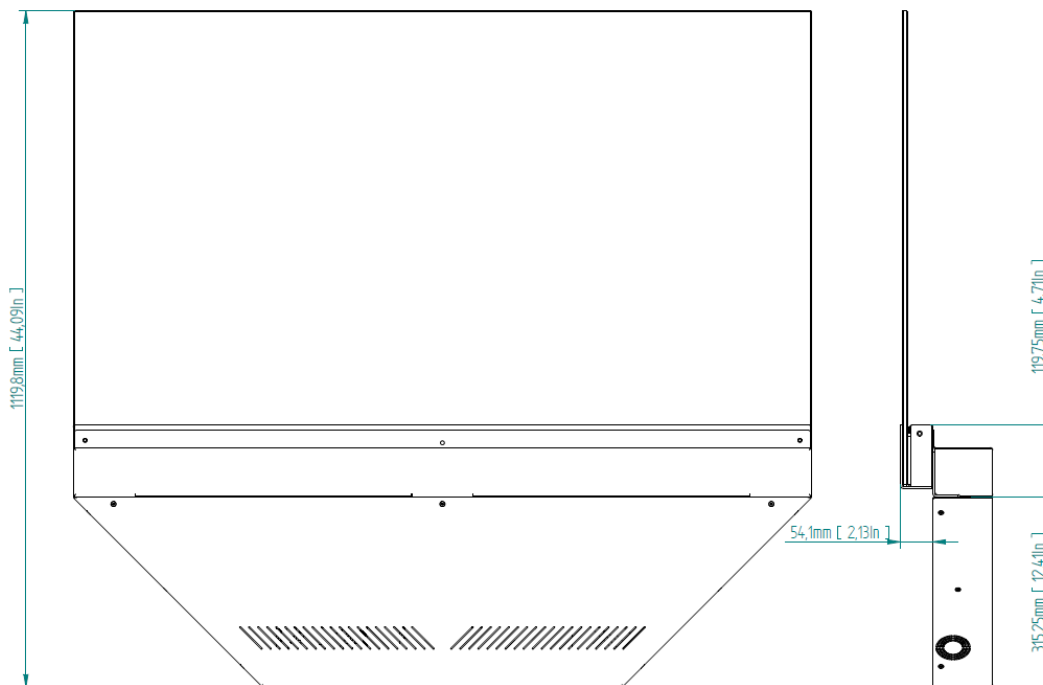

Figure 20: GhostT-OLED-I SOV Option, back, side view

## 11.2 Drawings GhostT-OLED-PT

### 11.2.1 Table-Stand Version

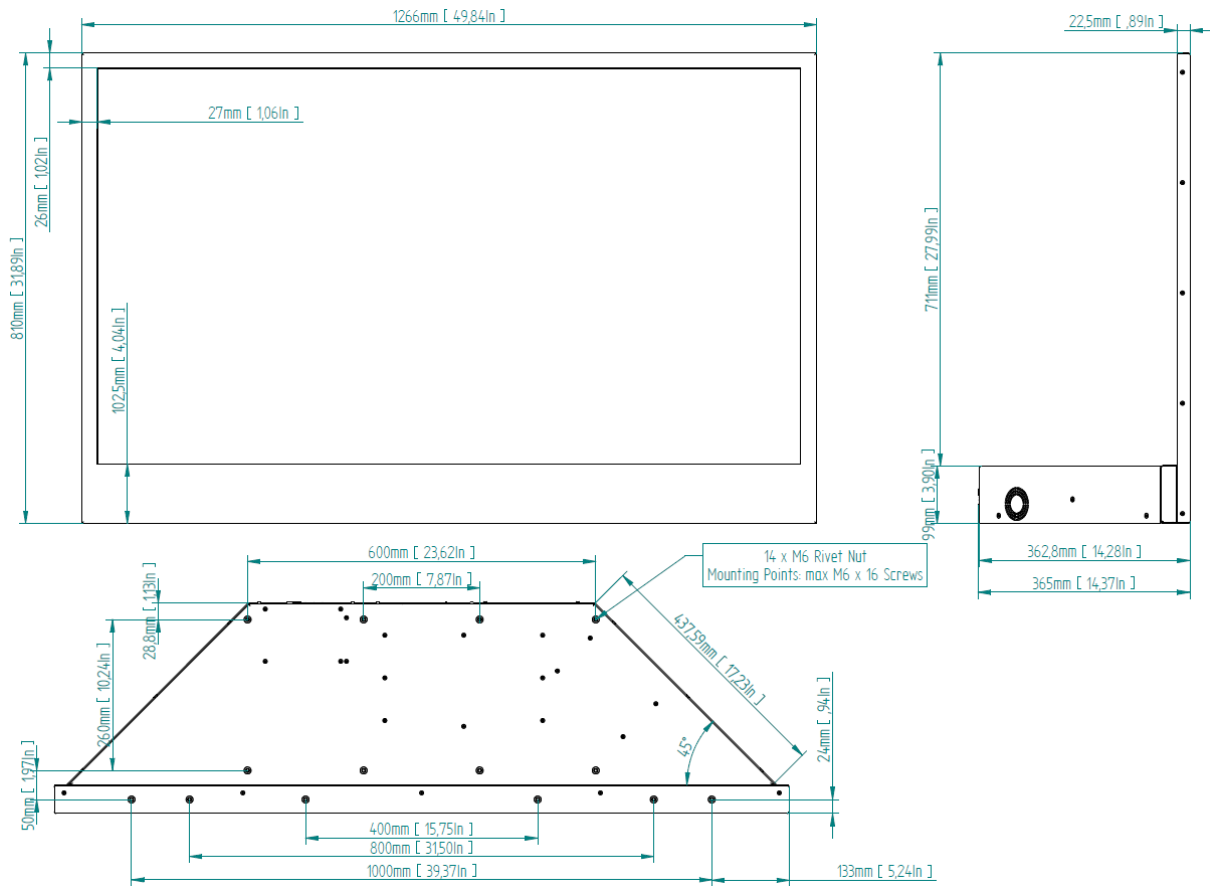

Figure 21: GhostT-OLED-PT TV Option front, side, bottom view

### 11.2.2 Straight Version

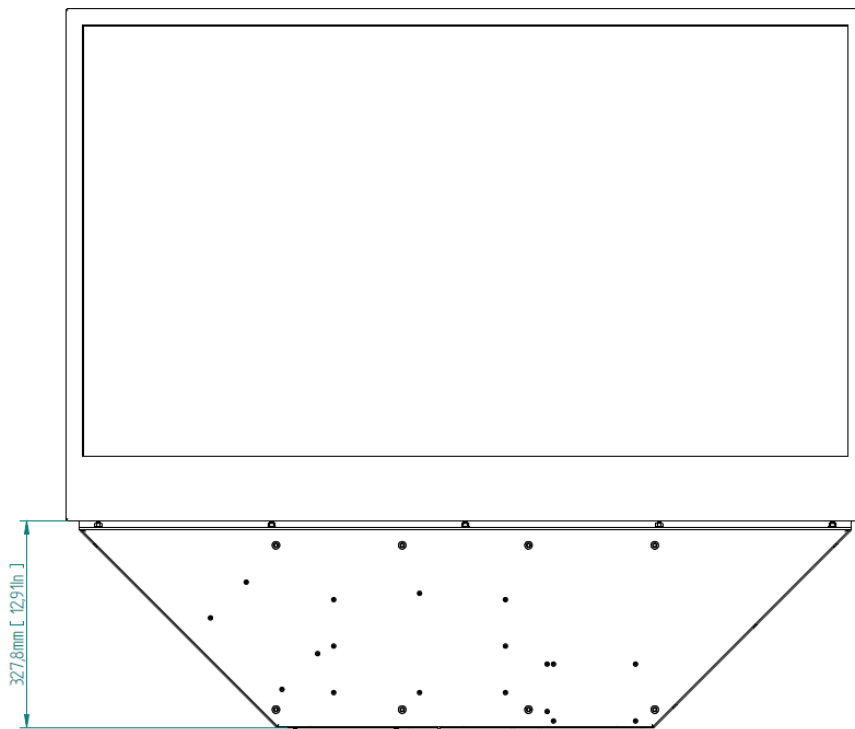

Figure 22: GhostT-OLED-PT SV Option front view

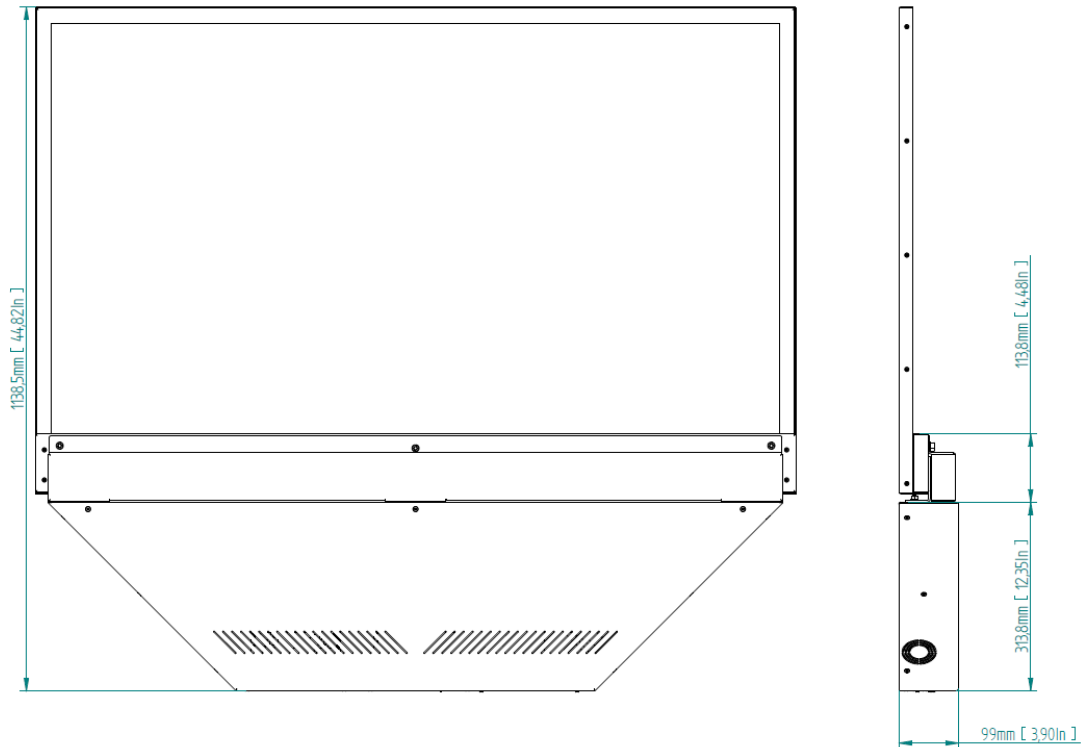

Figure 23: GhostT-OLED-PT SV Option back, side view

### 11.2.3 Straight Offset Version

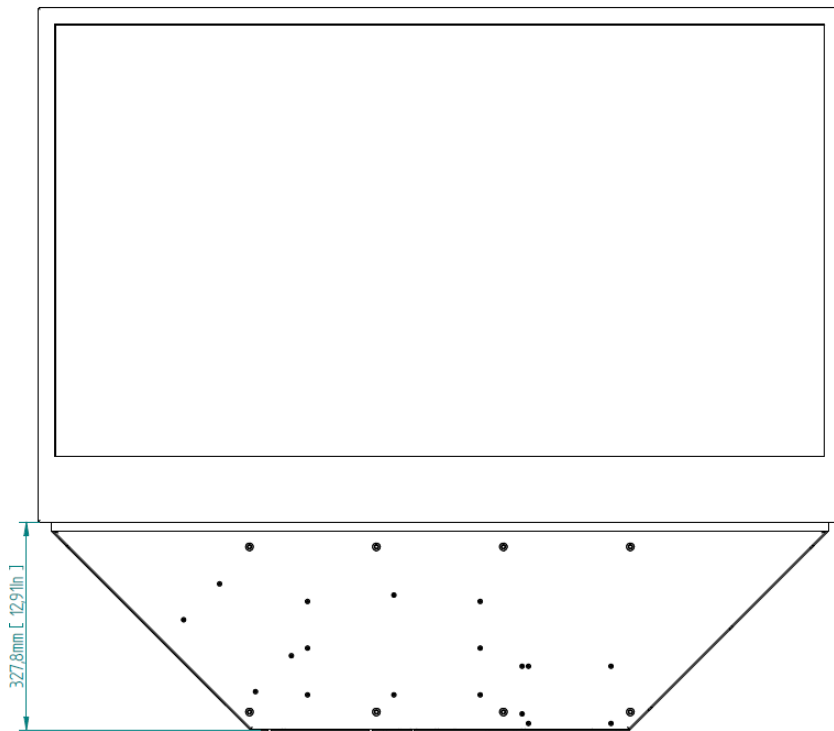

Figure 24: GhostT-OLED-PT SOV Option front view

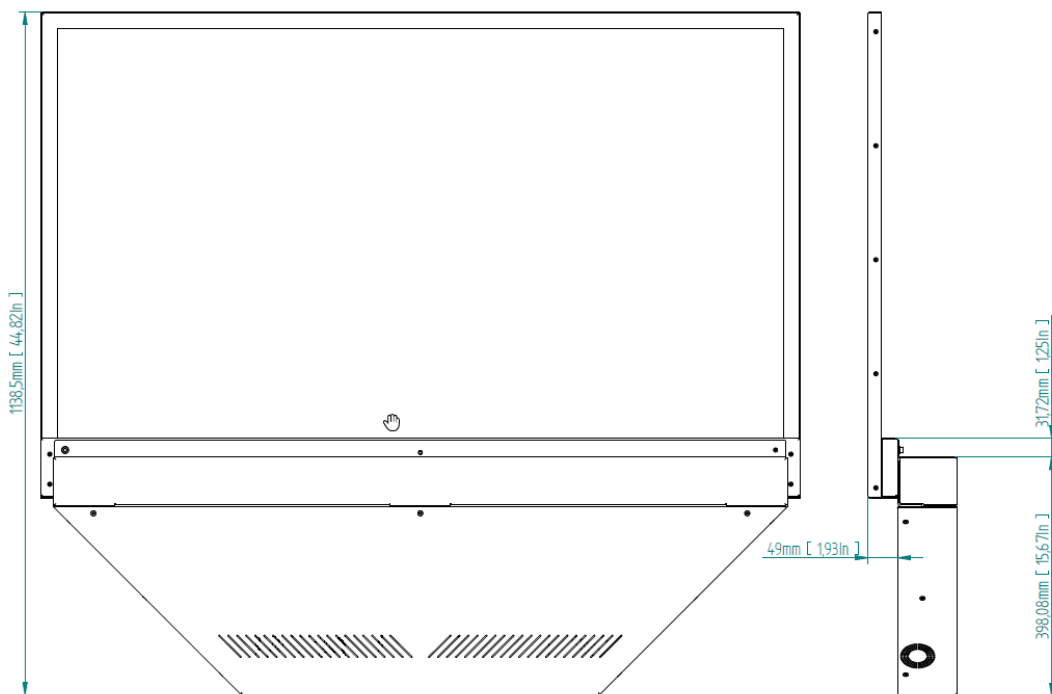

Figure 25: GhostT-OLED-PT SOV Option back, side view

## 12. Certification



for perfect presentations

### Declaration of Conformity

We hereby confirm that the following described machine in it's conception, construction and form put by us into circulation is in full accordance with all relevant CE and FCC Standards:

**Directive:**

2014/30/EU

**Emission:**

EN 55032:2012/AC:2013

EN 61000-3-2:2014

EN 61000-3-3:2013

Mains Conducted + Radiated Emission 150 kHz - 6 GHz

Harmonics & Flicker

Harmonics & Flicker

**Immunity: EN 55024 including**

IEC 61000-4-2:2009

IEC 61000-4-3:2006+A1:2008+A2:2010

IEC 61000-4-4:2012

IEC 61000-4-5:2014

IEC 61000-4-6:2013

IEC 61000-4-11:2004

ESD (air + contact)

HF-EMF

Burst

Surge (mains)

Conducted RF (mains + signal)

Interrupts & Dips

**FCC Testing Part 15B, Unintentional Emissions:**

Radiated Emission up to 1 GHz

Radiated Emission u 1 – 6 GHz

Mains Conducted + Radiated Emission

Radiated Emission

This declaration is no longer valid, if the machine is modified without our consent.

Manufacturer's name:

LANG AG  
Schlosserstraße 8  
D-51789 Lindlar  
Tel.: +49(0)2266/4764-0

Description of the machine:

- Function: Transparent OLED Display with primeTOUCH
- Type/model: GhosT-OLED 55 PT
- Year of construction: 2016

Place/date: *LINDLAR, 20.09.2016*

(Name, position of the signing person) *TOBIAS LANG, CEO*

Signature:

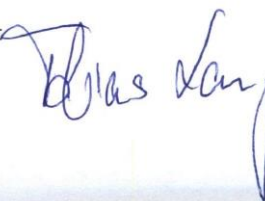

LANG AG  
SCHLOSSERSTR. 8  
51789 LINDLAR-GERMANY  
FON + 49 (0)2266 4764-0  
FAX + 49 (0)2266 4764-43

Made in Germany  
by



[www.lang-ag.com](http://www.lang-ag.com)

Schlosserstraße 8

51789 Lindlar

Germany

09/16