

# USER MANUAL

## LiveCore™ unit

(V04.02.20)

References:

ASC4806-4K-PL, ASC3204-4K-PL, ASC1602-4K, SMX12x4, NXT1604-4K,  
NXT0802-4K, LOE048-4K-PL, LOE032-4K, LOE016-4K



**ANALOG WAY®**  
*Pioneer in Analog, Leader in Digital*



# —○ THANK YOU

By following these simple steps you will be able to obtain the most from your powerful **LiveCore™ unit** and its many features related to the **version 04.02.20**.

|   |    |
|---|----|
| —○ <b>1. TRADEMARKS</b> .....   | 6  |
| —○ <b>2. INTRODUCTION</b> .....   | 6  |
| —○ <b>3. TERMS AND DEFINITIONS</b> .....                                  | 7  |
| —○ <b>4. HARDWARE SPECIFICATIONS</b> .....                                | 8  |
| <b>4.1 Safety instructions</b> .....                                      | 8  |
| 4.1.1 English   |    |
| 4.1.2 French  |    |
| 4.1.3 Italian   |    |
| 4.1.4 German  |    |
| 4.1.5 Spanish   |    |
| <b>4.2 Unpacking and inspection</b> .....                                 | 13 |
| <b>4.3 Rack mount information</b> .....                                   | 13 |
| <b>4.4 Cable and adaptor information</b> .....                            | 14 |
| <b>4.5 Hardware specifications</b> .....                                  | 14 |
| 4.5.1 Signal descriptions   |    |
| 4.5.2 Supported video formats   |    |
| 4.5.3 Computer formats  |    |
| 4.5.4 Input Computer formats  |    |
| 4.5.5 Output Computer formats   |    |
| <b>4.6 Input specifications</b> .....                                     | 17 |
| <b>4.7 Output specifications</b> .....                                    | 20 |
| 4.7.1 Standard output   |    |
| 4.7.2 Monitoring output   |    |
| <b>4.8 Communication specifications</b> .....                             | 21 |
| 4.8.1 Serial interface  |    |
| 4.8.2 LAN interface   |    |
| 4.8.3 Protocol  |    |
| 4.8.4 IP address  |    |
| 4.8.5 USB host interface  |    |
| 4.8.6 Compliance  |    |
| <b>4.9 Environmental specifications</b> .....                             | 23 |
| 4.9.1 Ascender 48 - 4K - PL   |    |
| 4.9.2 Ascender 32 - 4K - PL   |    |
| 4.9.3 Ascender 16 - 4K  |    |
| 4.9.4 SmartMatriX Ultra   |    |
| 4.9.5 NeXtage 16 - 4K   |    |
| 4.9.6 NeXtage 08 - 4K   |    |
| 4.9.7 LiveCore™ Output Expander - Ref. LOE048-4K-PL, LOE032-4K, LOE016-4K |    |
| <b>4.10 HDCP management</b> .....   | 30 |
| 4.10.1 Input HDCP detection   |    |
| 4.10.2 Output HDCP detection  |    |

- 4.10.3 Keys' checking
- 4.10.4 Output management
- 4.10.5 HDCP Classification
- 4.10.6 Status

|  |    |
|--|----|
| ○ 5. CONNECTING A LIVECORE™ UNIT .....                 | 31 |
| 5.1 Description .....                                  | 31 |
| 5.1.1 Rear panel of 4RU LiveCore™ unit                 |    |
| 5.1.2 Rear panel of 4RU LiveCore™ unit - 4K option     |    |
| 5.1.3 Rear panel of 3RU LiveCore™ unit - 4K option     |    |
| 5.1.4 Rear panel of a LiveCore™ Output Expander        |    |
| 5.1.5 Front panel of Ascender 48 - 4K - PL             |    |
| 5.1.6 Front panel of Ascender 32 - 4K - PL             |    |
| 5.1.7 Front panel of Ascender 16 - 4K                  |    |
| 5.1.8 Front panel of SmartMatriX Ultra                 |    |
| 5.1.9 Front panel of NeXtage 16 - 4K                   |    |
| 5.1.10 Front panel of NeXtage 08 - 4K                  |    |
| 5.1.11 Front panel of a LiveCore™ Output Expander      |    |
| ○ 6. CONTROLLING A LIVECORE™ UNIT .....                | 45 |
| 6.1 Web-based RCS requirement .....                    | 45 |
| 6.2 Connecting with the Web RCS .....                  | 45 |
| 6.3 Web RCS top Menu .....                             | 46 |
| 6.3.1 Setup  |    |
| 6.3.2 Edit   |    |
| 6.3.3 Live   |    |
| ○ 7. OPERATING A LIVECORE™ UNIT FROM THE WEB RCS ..... | 47 |
| 7.1 Functional mode .....                              | 47 |
| 7.2 Display configurations .....                       | 47 |
| 7.2.1 Single device configuration                      |    |
| 7.3 Setup .....  | 49 |
| 7.3.1 Internal rate                                    |    |
| 7.3.2 Link section                                     |    |
| 7.3.3 Outputs section                                  |    |
| 7.3.4 Screens  |    |
| 7.3.5 Inputs section                                   |    |
| 7.3.6 Logos  |    |
| 7.3.7 Native background section                        |    |
| 7.3.8 The Miscellaneous section                        |    |
| 7.3.9 Output management                                |    |
| 7.3.10 Input management                                |    |
| 7.3.11 Library management                              |    |
| 7.3.12 Logo management                                 |    |
| 7.3.13 Monitoring management                           |    |
| 7.3.14 Blending management                             |    |
| 7.3.15 Services management (update)                    |    |
| 7.3.16 Control management                              |    |

|  |     |
|--|-----|
| 7.4 Edit .....   | 79  |
| 7.4.1 Layer management   |     |
| 7.4.2 Layer properties   |     |
| 7.4.3 Layer settings   |     |
| 7.4.4 Layer selection and native background                              |     |
| 7.4.5 Preset load and save management                                    |     |
| 7.4.6 Logos and Frames management  |     |
| 7.4.7 Inputs management  |     |
| 7.4.8 Monitoring management  |     |
| 7.4.9 Confidence management  |     |
| 7.5 Live .....   | 94  |
| 7.6 How to operate Perspective Layers on the Ascender 48 - 4K - PL ..... | 98  |
| 7.6.1 Edit page  |     |
| 7.6.2 Memories and AUTOSCALE with Perspective Layers                     |     |
| —○ 8. OPERATING THROUGH THE FRONT PANEL .....                            | 100 |
| 8.1 Front panel .....  | 100 |
| 8.1.1 Front panel update   |     |
| 8.1.2 LCD screen   |     |
| 8.1.3 Front panel buttons  |     |
| 8.2 Menu tree .....  | 103 |
| —○ 9. ADDITIONAL REMOTE CONTROL SYSTEMS .....                            | 114 |
| —○ 10. ASSEMBLING AND DEVICES COUPLING .....                             | 115 |
| 10.1 Additive Modularity Linked mode .....                               | 115 |
| 10.2 Associative Modularity mode .....                                   | 116 |
| —○ 11. MAINTENANCE AND SUPPORT .....                                     | 118 |
| 11.1 Auto Calibration .....  | 118 |
| 11.2 Dashboard (Web RCS) .....   | 119 |
| —○ 12. APPLICATIONS NOTE AND TIPS .....                                  | 120 |
| 12.1 HDCP .....  | 120 |
| —○ 13. WARRANTY .....  | 121 |
| 13.1 Warranty conditions .....   | 121 |
| 13.2 Repair and return instructions .....                                | 121 |
| 13.3 Return conditions .....   | 121 |
| —○ 14. CONTACT INFORMATION .....   | 122 |
| —○ 15. APPENDICES .....  | 123 |

## —○ 1. TRADEMARKS

The terms HDMI, HDMI High-Definition Multimedia Interface and the HDMI Logo are trademarks or registered trademarks of HDMI Licensing LLC in the United States and other countries.

## —○ 2. INTRODUCTION

Thank you for choosing an Analog Way **LiveCore™ unit**. Before you start setting up your **LiveCore™ unit** for the first time, please read through all of the documentation to become familiar with its powerful features. A **LiveCore™ unit** can be used in several configurations, which results in a versatile video production tool for live event staging and fixed installation applications.



**Go on our website to register your product(s) and be notified about new firmware versions:**

<http://www.analogway.com/en/support/product-registration/>

## 3. TERMS AND DEFINITIONS

**BACKGROUND:** a “Background” is a source, typically originating from a computer. A **LiveCore™ unit** enables you to work with live or still (Frame) background sources — visually in back of all other sources.

**LAYER:** a “Layer” is an image display element (such as a PIP window, Key, Logo or Background) that has a visual priority — either in front (or in back) of another layer. Depending on the **LiveCore™ unit** type, up to 6 independent true-seamless scaled layers are available.

**PIP:** a “PIP” (Picture In Picture) is a picture, typically of reduced size, which is positioned over another background image or other PIPs. PIPs can be repositioned, reduced, enlarged and displayed with borders. PIPs can overlap, depending on their visual priority. A **LiveCore™ unit** offers various slides, wipes, and fades for dynamic PIP entrances and exits. A “flying” PIP is also possible using vertical, horizontal, diagonal, or curved movement. A PIP is considered a layer.

**FRAME:** a “Frame” is a full screen image which is selected from one of the still Frames loaded on the **LiveCore™ unit**. Frames are imported from a computer through the Web RCS.

**LOGO:** a “Logo” is an image imported from a computer, through the Web RCS. It can be keyed, resized and displayed on a layer. A **LiveCore™ unit** can also resize the logo to be displayed in any size on the screen by resizing and place the related layer.

**KEYING:** “Key” is an electronic process whereby a video image is electronically superimposed over another source or background, by dynamically removing a portion of the first image. For example, removing all content of a certain color (such as green or blue) is called a cutting out either a color (Chroma Key,) and removing content based on its brightness or luminance levels is called a (Luma Key). Keys are typically used for titles, Logos and special effects. A **LiveCore™ unit** allows you to key use a live source with Luma or Chroma key effects with green or blue background and to display key it over any other source or sources.

**SCREEN:** A “Screen” is a destination where the picture will be displayed. For example, it could be a single display or a projection surface which can be composed of one or several outputs. Each screen might composed with of one or several layers.

**SEAMLESS:** Clean transition with no glitch or loss of sync while switching between two sources. For example, fading through black to another source is a seamless transition.

**TRUE SEAMLESS:** Clean seamless transitions with no glitch or freeze between two sources. For example, crossfading from source to source is a true seamless transition.

**WEB RCS:** Web browser based Remote Control Software used to control, set up, and operate the device.

**SOFT EDGE:** Soft Edge blending technology is used to compensate for the overlap or covering area when two (or more) video projectors are combined to display a continuous content across one screen. The resulting image will appear as though it were a single unified picture.

**HARD EDGE:** Hard Edge technology is used to display continuous content using to several outputs without any overlap or covering area. The outputs are “side by side”, they don’t overlap or share pixel information. (Opposed to Soft Edge where some parts of the image are simultaneously on several displays.)

**CONFIDENCE MONITOR:** Confidence monitoring consists on using an output to display a specific content such as another screen, input or combination there-of. You can display one of the main outputs or Preview output content. For example, you might use the confidence monitor to show both the presenter’s laptop input as well as the Program screen on a single display.

## 4. HARDWARE SPECIFICATIONS

### 4.1 Safety instructions

#### 4.1.1 English

All of the safety and operating instructions should be read before the product is operated and should be maintained for further reference. Please follow all of the warnings on this product and its operating instructions.

- **WARNING:** To prevent the risk of electric shock and fire, do not expose this device to rain, humidity or intense heat sources (such as heaters and direct sunlight). Slots and openings in the device are provided for ventilation and to avoid overheating. Make sure the device is never placed near a textile surface that could block the openings. Also keep away from excessive dust, vibrations and shocks.
- **POWER:** Only use the power supply indicated on the device of the power source. Devices equipped with a grounding plug should only be used with a grounding type outlet. In no way should this grounding be modified, avoided or suppressed. Connection of equipment to main supply must be after branch circuit breaker of the building installation.
- **POWER CORD:** The device is equipped with a detachable power cord, to remove mains disconnect it at appliance coupler.

**Caution:** The power cord constitutes the only mean to completely disconnect the equipment from the main power.

#### Apply the following guidelines:

- The equipment connected to the network must have a release system easily accessible and located outside the unit.
- Unplug the power cord; do not pull on the power cord but always on the plug itself.
- The outlet should always be near the device and easily accessible.
- Power supply cords should be routed so that they are not likely to be walked on or pinched by items placed upon or against them.

If the power supply cord is damaged, unplug the device. Using the device with a damaged power supply cord may expose your device to electric shocks or other hazards. Verify the condition of the power supply cords once in a while. Contact your dealer or service center for replacement if damaged.

- **CONNECTIONS:** All inputs and outputs (except for the power input) are Safety Extra Low Voltage (SELV) circuits as defined in UL/IEC 60950-1.
- **SERVICING:** Do not attempt to service this product yourself by opening or removing covers and screws since it may expose your device to electric shocks or other hazards. Refer all problems to qualified service personnel.
- **OPENINGS:** Never push objects of any kind into this product through the openings. If liquids have been spilled or objects have fallen into the device, unplug it immediately and have it checked by a qualified technician.



### 4.1.2 French

Afin de mieux comprendre le fonctionnement de cet appareil nous vous conseillons de bien lire toutes les consignes de sécurité et de fonctionnement avant utilisation. Conservez les instructions de sécurité et de fonctionnement afin de pouvoir les consulter ultérieurement. Respectez toutes les consignes marquées dans la documentation, sur le produit et sur ce document.

- **ATTENTION** : Afin de prévenir tout risque de choc électrique et d'incendie, ne pas exposer cet appareil à la pluie, à l'humidité ou à des sources de chaleur intense.
- **INSTALLATION** : Veillez à assurer une circulation d'air suffisante pour éviter toute surchauffe à l'intérieur de l'appareil. Ne placez pas l'appareil sur ou à proximité d'une surface textile susceptible d'obstruer les orifices de ventilation. N'installez pas l'appareil à proximité de sources de chaleur comme un radiateur ou une poche d'air chaud, ni dans un endroit exposé au rayonnement solaire direct, à des poussières excessives, à des vibrations ou à des chocs mécaniques. Ceci pourrait provoquer un mauvais fonctionnement et un accident.
- **ALIMENTATION** : Ne faire fonctionner l'appareil qu'avec la source d'alimentation indiquée sur l'appareil. Les appareils doivent être obligatoirement connectés sur une source équipée d'une mise à la terre efficace. En aucun cas cette liaison de terre ne devra être modifiée, contournée ou supprimée. Raccordement des équipements à l'alimentation principale doit être postérieur au disjoncteur de branchement de l'installation électrique du bâtiment.
- **CORDON D'ALIMENTATION** : Les appareils sont équipés d'un cordon d'alimentation détachable, la mise hors tension se fait en débranchant ce cordon de l'appareil.

**Attention** : Le cordon d'alimentation constitue le seul moyen de débrancher l'appareil totalement de l'alimentation secteur. Pour être certain que l'appareil n'est plus alimenté, ce cordon doit être débranché de la prise murale.

#### Appliquer les consignes suivantes :

- Le matériel relié à demeure au réseau, doit avoir un dispositif de sectionnement facilement accessible qui doit être incorporé à l'extérieur de l'appareil.
- Débrancher le cordon d'alimentation de la prise murale si vous prévoyez de ne pas utiliser l'appareil pendant quelques jours ou plus.
- Pour débrancher le cordon, tirez-le par la fiche. Ne tirez jamais sur le cordon proprement dit.
- La prise d'alimentation doit se trouver à proximité de l'appareil et être aisément accessible.
- Ne laissez pas tomber le cordon d'alimentation et ne posez pas d'objets lourds dessus.

Si le cordon d'alimentation est endommagé, débranchez-le immédiatement de la prise murale. Il est dangereux de faire fonctionner un appareil avec un cordon endommagé ; un câble abîmé peut provoquer un risque d'incendie ou un choc électrique. Vérifiez le câble d'alimentation de temps en temps. Contactez votre revendeur ou le service après-vente pour un remplacement.

- **CONNEXIONS** : Toutes les entrées et sorties (exceptée l'entrée d'alimentation) sont des circuits de très basse tension de sécurité (TBTS) tels que définis dans UL / IEC 60950-1.
- **RÉPARATION ET MAINTENANCE** : L'utilisateur ne doit en aucun cas essayer de procéder aux opérations de dépannage, car l'ouverture des appareils par retrait des capots ou de toutes autres pièces constituant les boîtiers ainsi que le dévissage des vis apparentes à l'extérieur, risquent d'exposer l'utilisateur à des chocs électriques ou autres dangers. Contactez le service après-vente, votre revendeur ou adressez-vous à un personnel qualifié uniquement.
- **OUVERTURES ET ORIFICES** : Les appareils peuvent comporter des ouvertures (aération, fentes, etc...), veuillez ne jamais y introduire d'objets et ne jamais obstruer ses ouvertures. Si un liquide ou un objet pénètre à l'intérieur de l'appareil, débranchez immédiatement l'appareil et faites-le contrôler par un personnel qualifié avant de le remettre en service.

### 4.1.3 Italian

Allo scopo di capire meglio il funzionamento di questa apparecchiatura vi consigliamo di leggere bene tutti i consigli di sicurezza e di funzionamento prima dell'utilizzo. Conservare le istruzioni di sicurezza e di funzionamento al fine di poterle consultare ulteriormente. Seguire tutti i consigli indicati su questo manuale e sull'apparecchiatura.

- **ATTENZIONE:** Al fine di prevenire qualsiasi rischio di shock elettrico e d'incendio, non esporre l'apparecchiatura a pioggia, umidità e a sorgenti di eccessivo calore.
- **INSTALLAZIONE:** Assicuratevi che vi sia una sufficiente circolazione d'aria per evitare qualsiasi surriscaldamento all'interno dell'apparecchiatura. Non collocare l'apparecchiatura in prossimità o su superfici tessili suscettibili di ostruire il funzionamento della ventilazione. Non installate l'apparecchiatura in prossimità di sorgenti di calore come un radiatore o una fuoruscita d'aria calda, né in un posto esposto direttamente ai raggi del sole, a polvere eccessiva, a vibrazioni o a shock meccanici. Ciò potrebbe provocare un erroneo funzionamento e un incidente.
- **ALIMENTAZIONE:** Far funzionare l'apparecchiatura solo con la sorgente d'alimentazione indicata sull'apparecchiatura. Le apparecchiature queste devono essere obbligatoriamente collegate su una sorgente fornita di una efficiente messa a terra. In nessun caso questo collegamento potrà essere modificato, sostituito o eliminato. Connessione delle apparecchiature alla rete elettrica deve essere successiva interruttore di circuito dell'impianto dell'edificio
- **CAVO DI ALIMENTAZIONE:** Il dispositivo è dotato di un cavo di alimentazione removibile, per rimuovere alimentazione scollegarlo dalla Presa.

**Attenzione:** il cavo di alimentazione è il solo modo di disconnettere l'apparecchio dell'alimentazione. Per assicurarsi che totalmente l'apparecchio non è più collegato, il cavo deve essere disconnesso della presa murale.

#### Seguire le istruzioni seguenti:

- Il materiale collegato a residenza alla rete, deve avere un dispositivo di sezionamento facile da raggiungere e che deve essere inserito all'esterno del apparecchio.
- Disconnettere l'apparecchiatura dalla presa murale se si prevede di non utilizzarla per qualche giorno.
- Per disconnettere il cavo tirare facendo forza sul connettore.
- La presa d'alimentazione deve trovarsi in prossimità dell'apparecchiatura ed essere facilmente accessibile.
- Non far cadere il cavo di alimentazione né appoggiarsi sopra degli oggetti pesanti. Se il cavo di alimentazione è danneggiato, spegnere immediatamente l'apparecchiatura.

E' pericoloso far funzionare questa apparecchiatura con un cavo di alimentazione danneggiato, un cavo graffiato può provocare un rischio di incendio o uno shock elettrico. Verificare il cavo di alimentazione spesso. Contattare il vostro rivenditore o il servizio assistenza per una sostituzione.

- **CONNESSIONE:** Tutti gli ingressi e le uscite (tranne che per la potenza in ingresso) sono bassissima tensione di sicurezza (SELV) circuiti definiti UL / IEC 60950-1.
- **RIPARAZIONI E ASSISTENZA:** L'utilizzatore non deve in nessun caso cercare di riparare l'apparecchiatura, poiché con l'apertura del coperchio metallico o di qualsiasi altro pezzo costituente la scatola metallica, nonché svitare le viti che appaiono esteriormente, poiché ciò può provocare all'utilizzatore un rischio di shock elettrico o altri rischi.
- **APERTURE DI VENTILAZIONE:** Le apparecchiature possono comportare delle aperture di ventilazione, si prega di non introdurre mai oggetti o ostruire le sue fessure. Se un liquido o un oggetto penetra all'interno dell'apparecchiatura, disconnetterla e farla controllare da personale qualificato prima di rimetterla in servizio.

#### 4.1.4 German

Um den Betrieb dieses Geräts zu verstehen, raten wir Ihnen vor der Inbetriebnahme alle Sicherheits- und Betriebsanweisungen genau zu lesen. Diese Sicherheits- und Betriebsanweisungen für einen späteren Gebrauch sicher aufbewahren. Alle in den Unterlagen, an dem Gerät und hier angegebenen Sicherheitsanweisungen einhalten.

- **ACHTUNG:** um jegliches Risiko eines Stromschlags oder Feuers zu vermeiden, das Gerät nicht Regen, Feuchtigkeit oder intensiven Wärmequellen aussetzen.
- **EINBAU:** Eine ausreichende Luftzufuhr sicherstellen, um jegliche Überhitzung im Gerät zu vermeiden. Das Gerät nicht auf und in Nähe von Textiloberflächen, die Belüftungsöffnungen verschließen können, aufstellen. Das Gerät nicht in Nähe von Wärmequellen, wie z.B. Heizkörper oder Warmluftkappe, aufstellen und es nicht dem direkten Sonnenlicht, übermäßigem Staub, Vibrationen oder mechanischen Stößen aussetzen. Dies kann zu Betriebsstörungen und Unfällen führen.
- **STROMVERSORGUNG:** Das Gerät nur mit der auf dem Gerät bezeichnete Stromquelle betreiben. Gerät mit geerdeter Hauptstromversorgung muss an eine Stromquelle mit effizienter Erdung angeschlossen werden. Diese Erdung darf auf keinen Fall geändert, umgangen oder entfernt werden. Anschluss von Geräten ans Stromnetz muss nach Abzweigschalter des Gebäudes Installation
- **NETZKABEL:** Das Gerät ist mit einem lösbaren Netzkabel ausgestattet ; um es völlig vom Netz zu trennen, ziehen Sie bitte das Netzkabel aus der Kaltgerätebuchse.

**Achtung:** Das Netzkabel stellt die einzige Möglichkeit dar, das Gerät vollständig vom Netzanschluss zu trennen. Um sicherzustellen, dass das Gerät nicht mehr versorgt wird, muss dieses Kabel aus der Netzsteckdose ausgesteckt werden.

#### Bitte beachten Sie die folgenden Hinweise:

- Wenn Geräte dauerhaft am Netz bleiben, müssen sie über eine leicht zugängliche Trennvorrichtung verfügen, die außen am Gerät angebracht sein muss.
- Das Kabel mittels dem Stecker herausziehen. Niemals am Stromkabel selbst ziehen.
- Die Steckdose muß sich in der Nähe des Geräts befinden und leicht zugänglich sein.
- Das Stromkabel nicht fallen lassen und keine schweren Gegenstände auf es stellen.

Wenn das Stromkabel beschädigt ist, das Gerät sofort abschalten. Es ist gefährlich das Gerät mit einem beschädigten Stromkabel zu betreiben; ein abgenutztes Kabel kann zu einem Feuer oder Stromschlag führen. Das Stromkabel regelmäßig untersuchen. Für den Ersatz, wenden Sie sich an Ihren Verkäufer oder Kundendienststelle.

- **ANSCHLÜSSE:** Alle Eingänge und Ausgänge (mit Ausnahme der Stromversorgung) sind Safety Extra Low Voltage (SELV) Schaltungen wie in UL / IEC 60950-1 definiert.
- **REPARATUR UND WARTUNG:** Der Benutzer darf keinesfalls versuchen das Gerät selbst zu reparieren, die Öffnung des Geräts durch Abnahme der Abdeckhaube oder jeglichen anderen Teils des Gehäuses sowie die Entfernung von außen sichtbaren Schrauben zu Stromschlägen oder anderen Gefahren für den Benutzer führen kann. Wenden Sie sich an Ihren Verkäufer, Ihre Kundendienststelle oder an qualifizierte Fachkräfte.
- **ÖFFNUNGEN UND MUNDUNGEN:** Die Geräte können über Öffnungen verfügen (Belüftung, Schlitze, usw.). Niemals Gegenstände in die Öffnungen einführen oder die Öffnungen verschließen. Wenn eine Flüssigkeit oder ein Gegenstand in das Gerät gelangt, den Stecker herausziehen und es vor einer neuen Inbetriebnahme von qualifiziertem Fachpersonal überprüfen lassen.

### 4.1.5 Spanish

Para comprender mejor el funcionamiento de este aparato, le recomendamos que le acudadosamente todas las consignas de seguridad y de funcionamiento del aparato antes de usarlo. Conserve las instrucciones de seguridad y de funcionamiento para que pueda consultarlas posteriormente. Respete todas las consignas indicadas en la documentación, relacionadas con el producto y este documento.

- **CUIDADO:** Para prevenir cualquier riesgo de choque eléctrico y de incendio, no exponga este aparato a la lluvia, a la humedad ni a fuentes de calor intensas.
- **INSTALACIÓN:** Cerciórese de que haya una circulación de aire suficiente para evitar cualquier sobrecalentamiento al interior del aparato. No coloque el aparato cerca ni sobre una superficie textil que pudiera obstruir los orificios de ventilación. No instale el aparato cerca de fuentes de calor como radiador o boca de aire caliente, ni en un lugar expuesto a los rayos solares directos o al polvo excesivo, a las vibraciones o a los choques mecánicos. Esto podría provocar su mal funcionamiento o un accidente.
- **ALIMENTACIÓN:** Ponga a funcionar el aparato únicamente con la fuente de alimentación que se indica en el aparato. Los aparatos deben estar conectados obligatoriamente a una fuente equipada con una puesta a tierra eficaz. Por ningún motivo este enlace de tierra deberá ser modificado, cambiado o suprimido. Conexión del equipo a la red eléctrica debe ser posterior del interruptor de circuitos derivados de la instalación del edificio
- **CABLE DE CORRIENTE:** El equipo se suministra con un cable de corriente si desconectamos el cable dejamos al equipo sin alimentación.

**Atención:** El cable de alimentación constituye el único medio de desconectar el aparato totalmente de la red eléctrica. Para estar seguro de que el aparato no está más alimentado, este cable debe de ser desconectado de la toma de corriente.

#### Aplicar las siguientes consignas:

- El material conectado a residencia a la red informática, debe de tener un dispositivo de seccionamiento fácilmente accesible que debe de ser incorporado al exterior del aparato.
- Desconectar el aparato del enchufe mural si no piensa utilizarlo durante varios días.
- Para desconectar el cable, tire de la clavija. No tire nunca del cable propiamente dicho.
- El enchufe de alimentación debe estar cerca del aparato y ser de fácil acceso.
- No deje caer el cable de alimentación ni coloque objetos pesados encima de él.

Si el cable de alimentación sufriera algún daño, ponga el aparato inmediatamente fuera de tensión. Es peligroso hacer funcionar este aparato con un cable averiado, ya que un cable dañado puede provocar un incendio o un choque eléctrico. Verifique el estado del cable de alimentación de vez en cuando. Póngase en contacto con su distribuidor o con el servicio de posventa si necesita cambiarlo.

- **CONEXIONES:** Todas las entradas y salidas (a excepción de la entrada de alimentación) son de tensión extra baja de seguridad (SELV) circuitos definidos en UL / IEC 60950-1.
- **REPARACIÓN Y MANTENIMIENTO:** Por ningún motivo, el usuario deberá tratar de efectuar operaciones de reparación, ya que si abre los aparatos retirando el capó o cualquier otra pieza que forma parte de las cajas o si destornilla los tornillos aparentes exteriores, existe el riesgo de producirse una explosión, choques eléctricos o cualquier otro incidente. Contacte el servicio de posventa, a su distribuidor o diríjase con personal cualificado únicamente.
- **ABERTURAS Y ORIFICIOS:** Los aparatos pueden contener aberturas (aireación, ranuras, etc.). No introduzca allí ningún objeto ni obstruya nunca estas aberturas. Si un líquido o un objeto penetra al interior del aparato, desconéctelo y hágalo revisar por personal cualificado antes de ponerlo nuevamente en servicio.

## 4.2 Unpacking and inspection

- 1 x **LiveCore™ unit**
- 1 x Power supply cord
- 1 x Ethernet cross cable (for device control)
- 1 x Web-based Remote Control Software included and hosted on the device
- 1 x Rack mount kit
- 1 x User manual (PDF version)\*
- 1 x Quick start guide\*

\* User manual and Quick start guide are also available on [www.analogway.com](http://www.analogway.com)

### CAUTION!

Mounting using only the front rack ears is sufficient for fixed installations. Additional support, such as the rear rack support or slide rails, is required for mobile applications, and recommended for all.

Before racking and plugging any inputs and outputs, it is advised to power on the unit. Should you encounter any issue, you must contact immediately your local distributor or dealer, or closest **Analog Way** technical support offices (see chapter: **14. Contact information**).

## 4.3 Rack mount information

**Tabletop mounting:** **LiveCore™ unit** can be used directly on a table; the unit is equipped with 4 handy anti-slip rubber feet.

**Rack mounting:** **LiveCore™ unit** is compatible with a 19" enclosure. Please follow the instructions below to install the device in a 19" rack.

**CAUTION:** a 4U **LiveCore™ unit** weighs 42.77LBS (19,4Kg) and 3U weighs 30.86LBS (14Kg). Please provide appropriate support to the frame during installation. First, place ears on each side of the device (ref: 180469) Place the device in your rack. Attach the device to the rack by using 2 screws through the ears (screws not included).

Additional support, such as the rear rack support or slide rails, is required. **LiveCore™ unit** is equipped with threaded holes designed for compatibility with a rear rack mount such as ref. 180489. Use the holes in the rear support arm to adjust the length of the rear rack support arm in order to reach the rear rack rail when installed in the rack. Use four M4x10mm screws in the countersunk holes in the rear support bar on both sides of the unit.

A lacing bar is provided with the rack mount kit (ref: 180489). Install it with the M4x10 screws according to your cables position.

Connect all of the cables to the device and attach them to the lacing bar with the help of tie wraps.

### IMPORTANT:

- The openings in the front and rear panels of the device are for cooling. Air flows from front to back. Do not cover these openings to avoid cutting air circulation.
- The maximum ambient operating temperature should not exceed 40°C (104°F).
- The rack and all mounted equipment in it must be reliably grounded according to national and/or local electrical standards.



Dismantling front handles of the device could invalidate warranty on after-sales services of your **LiveCore™ unit**. It is strongly advised to avoid using front handles as rests for your **LiveCore™ unit**, they are designed for manipulation purposes only.

If required, front handles of the device can be dismantled, but with caution. The original screws removed must not be reintroduced to their location without handles in place. Substantial damages can occur, including risk of electric shock from the main voltage. Only M4x12mm screws can be used. They are supplied with the unit.

## 4.4 Cable and adaptor information

A large choice of cables and adaptors are compatible with the **LiveCore™ unit**. Please refer to the hardware specifications chapter to find the most suitable cables for your operations.

## 4.5 Hardware specifications

### 4.5.1 Signal descriptions

For each type of signal, here are the levels and the impedance accepted by the **LiveCore™ unit**.

#### Analog SDTV

| Type      | Levels  | Impedance      |
|-----------|---|----------------|
| Composite | 0,7 Vpp + 0,3 Vpp                                   | 75 Ω           |
| S. Video  | Y = 0,7 Vpp + 0,3 Vpp<br>C = 0,7 Vpp                | 75 Ω           |
| YUV       | Y = 0,7 Vpp + 0,3 Vpp<br>U = 0,7 Vpp<br>V = 0,7 Vpp | 75 Ω           |
| RGsB      | R = 0,7 Vpp<br>G = 0,7 Vpp + 0,3 Vpp<br>B = 0,7 Vpp | 75 Ω           |
| RGBS      | R, G, B = 0,7 Vpp                                   | R, G, B = 75 Ω |
|           | S = 0,3 Vpp 75 Ω<br>or<br>S = TTL                   |                |

#### Digital SDTV

| Type        | Characteristics   |
|-------------|---|
| SD-SDI      | YUV - 10 bits – 4.2.2 - 270 Mb/s<br>No payload ID management<br>Only A-level type |
| DVI         | RGB ou YUV – 8 bits – 4.4.4 – 16/235 - TMDS                                       |
| HDMI        | RGB or YUV – 10 bits – 4.4.4 or 4.2.2<br>– 16/235 – TMDS                          |
| DisplayPort | RGB or YUV – 10 bits – 4.4.4 or 4.2.2<br>– 16/235 – Main Link                     |

#### Analog EDTV

| Type | Levels  | Impedance      |
|------|---|----------------|
| YUV  | Y = 0,7 Vpp + 0,3 Vpp<br>U = 0,7 Vpp<br>V = 0,7 Vpp | 75 Ω           |
| RGsB | R = 0,7 Vpp<br>G = 0,7 Vpp + 0,3 Vpp<br>B = 0,7 Vpp | 75 Ω           |
| RGBS | R, G, B = 0,7 Vpp                                   | R, G, B = 75 Ω |
|      | S = 0,3 Vpp 75 Ω<br>or<br>S = TTL                   |                |

#### Digital EDTV

| Type        | Characteristics   |
|-------------|---|
| DVI         | RGB or YUV – 8 bits – 4.4.4 – 16/235 - TMDS                   |
| HDMI        | RGB or YUV – 10 bits – 4.4.4 or 4.2.2<br>– 16/235 – TMDS      |
| DisplayPort | RGB or YUV – 10 bits – 4.4.4 or 4.2.2<br>– 16/235 – Main Link |

### Analog HDTV

These formats are compatible with bi-level and tri-level sync on 1 or 3 wires.

| Type | Levels   | Impedance |
|------|--|-----------|
| YUV  | Y = 0,7 Vpp ±0,3 Vpp<br>U = 0,7 Vpp ±0,3 Vpp<br>V = 0,7 Vpp ±0,3 Vpp | 75 Ω      |
| RGsB | R = 0,7 Vpp ±0,3 Vpp<br>G = 0,7 Vpp ±0,3 Vpp<br>B = 0,7 Vpp ±0,3 Vpp | 75 Ω      |

### Digital HDTV

| Type        | Characteristics   |
|-------------|---|
| HD-SDI      | YUV - 10 bits – 4.2.2 – 1,485Gb/s and 1,485/1.001Gb/s<br>Only A-level type<br>Input and output payload ID management for HDTV format only |
| 3G-SDI      | YUV - 10 bits – 4.2.2 – 2,97Gb/s and 2,97/1.001Gb/s<br>Only A-level type<br>Input and output payload ID management for HDTV format only   |
| DVI         | RGB or YUV – 8 bits – 4.4.4 – 16/235 - TMDS   |
| DisplayPort | RGB or YUV – 8 bits – 4.4.4 or 4.2.2 – 16/235 – Main Link   |
| HDMI        | RGB or YUV – 10 bits – 4.4.4 or 4.2.2 – 16/235 – TMDS   |

### Analog computer

| Type  | Levels  | Impedance      |
|-------|---|----------------|
| RGsB  | R = 0,7 Vpp<br>G = 0,7 Vpp + 0,3 Vpp<br>B = 0,7 Vpp | 75 Ω           |
| RGBS  | R, G, B = 0,7 Vpp                                   | R, G, B = 75 Ω |
|       | S = 0,3 Vpp 75Ω or S = TTL                          |                |
| RGBHV | R, G, B = 0,7 Vpp                                   | R, G, B = 75 Ω |
|       | H = TTL and V = TTL                                 |                |

### Digital computer

| Type        | Characteristics   |
|-------------|---|
| DVI         | RGB – 8 bits – 4.4.4 – 0/255 - TMDS                       |
| HDMI®       | RGB or YUV – 10 bits – 4.4.4 or 4.2.2 – 0/255 – TMDS      |
| DisplayPort | RGB or YUV – 10 bits – 4.4.4 or 4.2.2 – 0/255 – Main Link |

### Digital UHDTV

| Type  | Characteristics                                     |
|-------|---|
| HDMI® | RGB or YUV – 8 bits – 4.4.4 or 4.2.2 – 0/255 – TMDS |

## 4.5.2 Supported video formats

A LiveCore™ unit can support all the following video formats:

### SDTV formats

| Standard | Size     | Vertical frequency | Horizontal frequency |
|----------|----------|--------------------|----------------------|
| NTSC     | 525/480i | 59.94Hz/60Hz       | 15,735 KHz           |
| PAL      | 625/576i | 50Hz               | 15.625 KHz           |
| SECAM    | 625/576i | 50Hz               | 15.625 KHz           |

### EDTV formats

| Standard | Size     | Vertical frequency | Horizontal frequency |
|----------|----------|--------------------|----------------------|
| 480p     | 525/480p | 59.94Hz/60Hz       | 31.47 KHz            |
| 576p     | 625/576p | 50Hz               | 31.25 KHz            |

### HDTV formats

| Standard | Size        | Vertical frequency                               |
|----------|-------------|--|
| 720p     | 1280 x 720  | 23.97Hz/24Hz/25Hz/29,97Hz/30Hz/50Hz/59.94Hz/60Hz |
| 1035i    | 1920 x 1035 | 59.94Hz/60Hz                                     |
| 1080i    | 1920 x 1080 | 50Hz/59.94Hz/60Hz                                |
| 1080sF   | 1920 x 1080 | 50Hz/59.94Hz/60Hz                                |
| 1080p    | 1920 x 1080 | 23.97Hz/24Hz/25Hz/29,97Hz/30Hz/50Hz/59.94Hz/60Hz |

### Cinema formats

| Format    | Size        | Vertical frequency             |
|-----------|-------------|--------------------------------|
| DCDM      | 2048 x 1080 | 24Hz                           |
| 4K 4:4:4  | 4096 x 2160 | 23.97Hz/24Hz/25Hz/29,97Hz/30Hz |
| 4K 4:2:0* | 4096 x 2160 | 50Hz/59,94Hz/60Hz              |

\*These 4:2:0 formats are only available on the outputs.

### UHDTV formats

| Standard     | Size        | Vertical frequency             |
|--------------|-------------|--------------------------------|
| 2160p 4:4:4  | 3840 x 2160 | 23.97Hz/24Hz/25Hz/29,97Hz/30Hz |
| 2160p 4:2:0* | 3840 x 2160 | 50Hz/59,94Hz/60Hz              |

\*These 4:2:0 formats are only available on the outputs.

## 4.5.3 Computer formats

**Important:** The maximum pixel clock frequency is 165 MHz. This corresponds to 1600x1200 @ 60 Hz, for single link. For dual and 4K resolutions, the maximum pixel clock frequency is 330 MHz.

## 4.5.4 Input Computer formats

The inputs of a LiveCore™ unit support GTF (version 1.1), CVT (version 1.1) and DMT (version 1.0 rev 12) standards. All others non-standard formats are supported via the custom format capability of the framework.



## 4.5.5 Output Computer formats

The outputs of a **LiveCore™ unit** support GTF (version 1.1), CVT (version 1.1) and DMT (version 1.0 rev 12) standards. Other non-standard formats are supported via the **Custom Format** capability.

A **LiveCore™ unit** offers a list of pre-defined output formats. The list of output formats is always displayed from increasing number of pixels per line and then number of lines.

| Format   | Size      | Aspect ratio | Frequency |       |
|----------|-----------|--------------|-----------|-------|
|          |           |              | 50 Hz     | 60 Hz |
| VGA      | 640x480   | 4/3          | No        | Yes   |
| WVGA     | 848x480   | 16/9         | No        | Yes   |
| SVGA     | 800x600   | 4/3          | No        | Yes   |
| 720p     | 1280x720  | 16/9         | Yes       | Yes   |
| XGA      | 1024x768  | 4/3          | Yes       | Yes   |
| WXGA     | 1280x768  | 5/3          | Yes       | Yes   |
| SWXGA    | 1360x768  | 16/9         | Yes       | Yes   |
| 1366x768 | 1366x768  | 16/9         | Yes       | Yes   |
| WXGA2    | 1280x800  | 16/9         | Yes       | Yes   |
| SWXGAP   | 1366x800  | 5/3          | Yes       | Yes   |
| XGA+     | 1152x864  | 4/3          | Yes       | Yes   |
| WXGA+    | 1440x900  | 16/10        | Yes       | Yes   |
| HD+      | 1600x900  | 16/9         | Yes       | Yes   |
| SXGA-    | 1280x960  | 4/3          | Yes       | Yes   |
| WXGA+    | 1440x960  | 3/2          | Yes       | Yes   |
| SXGA     | 1280x1024 | 5/4          | Yes       | Yes   |
|          | 1360x1024 | 4/3          | Yes       | Yes   |
| SXGAP    | 1400x1050 | 5/3          | Yes       | Yes   |
| WSXGAP   | 1680x1050 | 16/9         | Yes       | Yes   |
| 1080p    | 1920x1080 | 16/9         | Yes       | Yes   |

| Format               | Size      | Aspect ratio | Frequency |       |
|----------------------|-----------|--------------|-----------|-------|
|                      |           |              | 50 Hz     | 60 Hz |
| UHDTV Side by side** | 1920x2160 | N/A          | Yes       | Yes   |
| 2K                   | 2048x1080 | 17/9         | Yes       | Yes   |
| 4K Side by side**    | 2048x2160 | N/A          | Yes       | Yes   |
| UW-UXGA*             | 2560x1080 | 21/9         | Yes       | Yes   |
| QWXGA                | 2048x1152 | 16/9         | Yes       | Yes   |
| UXGA                 | 1600x1200 | 4/3          | Yes       | Yes   |
| WUXGA                | 1920x1200 | 16/9         | Yes       | Yes   |
| WQHD*                | 2560x1440 | 16/9         | Yes       | Yes   |
| QXGA*                | 2048x1536 | 4/3          | Yes       | Yes   |
| WQXGA*               | 2560x1600 | 16/10        | Yes       | Yes   |

\*Dual-Link format

\*\*Dual-Link format at 60Hz, Single-Link format at 30Hz, used with two outputs, side by side to make a 4K output

## 4.6 Input specifications

A **LiveCore™ unit** offers two or three input module cards. Each input module card contains 4 inputs. Each input is composed of several plugs. A plug corresponds to a socket on the rear panel.

The following types of plugs are available on the rear panel:

- 4-Lanes DisplayPort in version 1.1a (can accept a Dual-Link DVI input via a non-supplied active adaptor)
- HDMI
- Single DVI-I / Dual-Link DVI-D (DVI-I connector),
- 3G/HD/SD-SDI (BNC),
- Universal Analog (HD-15)

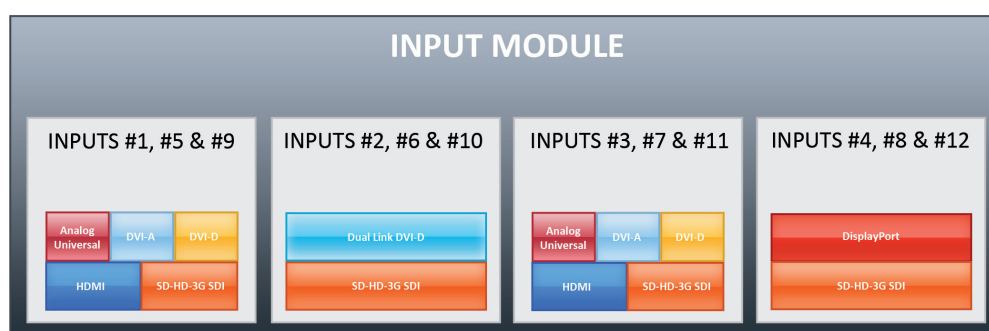

For devices with the 4K input card:

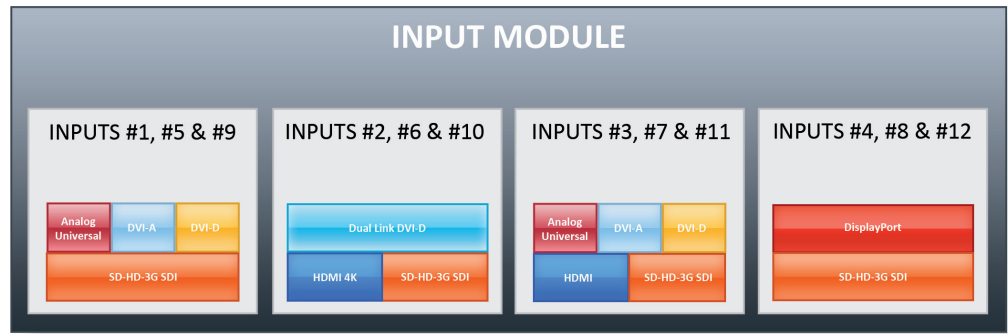

A **LiveCore™ unit** uses an HDMI plug with a standard mounting screw above the connector. Please see the diagram below.

This hole is occupied by a Torx10 screw when you receive the unit. If desired, this screw can be removed and replaced by a compatible aftermarket HDMI plug locking mechanism to ensure a secure HDMI connection.

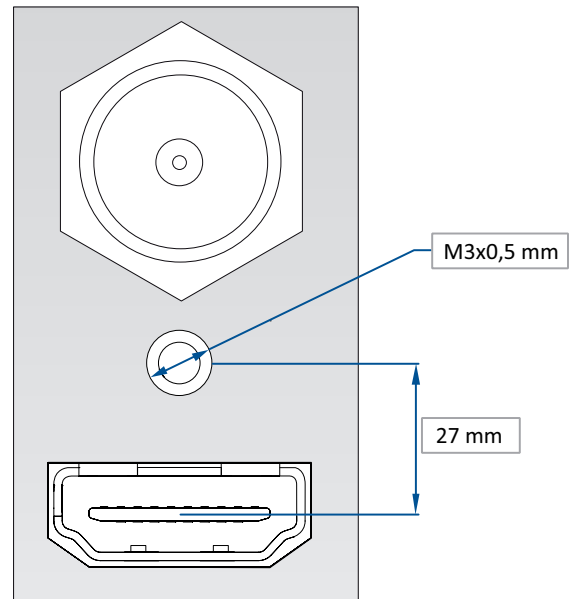

Please take a look at the accepted format regarding the input plug type:

| Plug Type              | Formats                             | Signals   |
|------------------------|-------------------------------------|---|
| Universal Analog Input | SDTV - EDTV - HDTV - Computer       | Analog SDTV - Analog EDTV - Analog HDTV - Analog Computer     |
| DVI-A Input            | SDTV - EDTV - HDTV - Computer       | Analog SDTV - Analog EDTV - Analog HDTV - Analog Computer     |
| DVI-D Input            | SDTV - EDTV - HDTV - Computer       | Digital SDTV - Digital EDTV - Digital HDTV - Digital Computer |
| DisplayPort Input      | SDTV - EDTV - HDTV - Computer       | Digital SDTV - Digital EDTV - Digital HDTV - Digital Computer |
| HDMI Input             | SDTV - EDTV - HDTV - Computer       | Digital SDTV - Digital EDTV - Digital HDTV - Digital Computer |
| HDMI 4K input*         | 4K DCI - UHDTV - SDTV - EDTV - HDTV | Digital SDTV - Digital EDTV - Digital HDTV - Digital UHDTV    |
| 3G/HD/SD-SDI Input     | SDTV - HDTV                         | Digital SDTV - Digital HDTV                                   |

\*only available with the 4K option

**WARNING:** Only the video signal is processed for the HDMI®, 3G/HD/SD-SDI and DisplayPort inputs; the embedded audio is not processed. All other HDMI® features such as: HDMI Ethernet Channel, Audio Return Channel, 3D, Content Type, Deep Color and x.v.Color are **NOT** supported.

Each input can display only one active plug at a time. It is instantly available on the device and can be displayed simultaneously on many layers or outputs, with different sizes and positions. Each input can be used independently except with the Dual-Link and Dual-Head configuration which are using two inputs.

| Standard            | Size      | HD-15                     | 3G-SDI | HDMI | HDMI 4K | 4-Lanes <sup>3</sup> DisplayPort | Single-Link DVI-I | Dual-Link DVI-D |
|---------------------|-----------|---------------------------|--------|------|---------|----------------------------------|-------------------|-----------------|
| NTSC                | 525/480i  | Yes                       | Yes    | Yes  | Yes     | No                               | No                | No              |
| PAL                 | 625/576i  | Yes                       | Yes    | Yes  | Yes     | No                               | No                | No              |
| SECAM               | 625/576i  | Yes                       | Yes    | Yes  | Yes     | No                               | No                | No              |
| 480p                | 525/480p  | Yes                       | No     | Yes  | Yes     | Yes                              | Yes               | Yes             |
| 576p                | 625/576p  | Yes                       | No     | Yes  | Yes     | Yes                              | Yes               | Yes             |
| 720p                | 1280x720  | Yes                       | Yes    | Yes  | Yes     | Yes                              | Yes               | Yes             |
| 1035i               | 1920x1035 | Yes                       | Yes    | Yes  | Yes     | Yes                              | Yes               | Yes             |
| 1080i               | 1920x1080 | Yes                       | Yes    | Yes  | Yes     | Yes                              | Yes               | Yes             |
| 1080p               | 1920x1080 | Yes                       | Yes    | Yes  | Yes     | Yes                              | Yes               | Yes             |
| 1080sF              | 1920x1080 | Yes                       | Yes    | Yes  | Yes     | Yes                              | Yes               | Yes             |
| 1080p               | 1920x1080 | Yes                       | Yes    | Yes  | Yes     | Yes                              | Yes               | Yes             |
| DCDM                | 2048x1080 | No                        | Yes    | No   | No      | No                               | No                | No              |
| VGA                 | 640x480   | Yes                       | No     | Yes  | Yes     | Yes                              | Yes               | Yes             |
| 800x480             | 800x480   | Yes                       | No     | Yes  | Yes     | Yes                              | Yes               | Yes             |
| WVGA                | 848x480   | Yes                       | No     | Yes  | Yes     | Yes                              | Yes               | Yes             |
| SVGA                | 800x600   | Yes                       | No     | Yes  | Yes     | Yes                              | Yes               | Yes             |
| 1280x600            | 1280x600  | Yes                       | No     | Yes  | Yes     | Yes                              | Yes               | Yes             |
| 720p RGB            | 1280x720  | Yes                       | No     | Yes  | Yes     | Yes                              | Yes               | Yes             |
| XGA                 | 1024x768  | Yes                       | No     | Yes  | Yes     | Yes                              | Yes               | Yes             |
| WXGA                | 1280x768  | Yes                       | No     | Yes  | Yes     | Yes                              | Yes               | Yes             |
| SWXGA               | 1360x768  | Yes                       | No     | Yes  | Yes     | Yes                              | Yes               | Yes             |
| 1366x768            | 1366x768  | Yes                       | No     | Yes  | Yes     | Yes                              | Yes               | Yes             |
| 800p RGB            | 1280x800  | Yes                       | No     | Yes  | Yes     | Yes                              | Yes               | Yes             |
| SWXGA+              | 1366x800  | Yes                       | No     | Yes  | Yes     | Yes                              | Yes               | Yes             |
| 1152x864            | 1152x864  | Yes                       | No     | Yes  | Yes     | Yes                              | Yes               | Yes             |
| 900p RGB            | 1440x900  | Yes                       | No     | Yes  | Yes     | Yes                              | Yes               | Yes             |
| 1600x900            | 1600x900  | Yes                       | No     | Yes  | Yes     | Yes                              | Yes               | Yes             |
| 960p RGB            | 1280x960  | Yes                       | No     | Yes  | Yes     | Yes                              | Yes               | Yes             |
| SXGA                | 1280x1024 | Yes                       | No     | Yes  | Yes     | Yes                              | Yes               | Yes             |
| 1360x1024           | 1360x1024 | Yes                       | No     | Yes  | Yes     | Yes                              | Yes               | Yes             |
| DILA4/3             | 1364x1024 | Yes                       | No     | Yes  | Yes     | Yes                              | Yes               | Yes             |
| SXGA+               | 1400x1050 | Yes                       | No     | Yes  | Yes     | Yes                              | Yes               | Yes             |
| WSXGA+              | 1680x1050 | Yes                       | No     | Yes  | Yes     | Yes                              | Yes               | Yes             |
| 1080p RGB           | 1920x1080 | Yes <sup>1</sup>          | No     | Yes  | Yes     | Yes                              | Yes               | Yes             |
| 2K                  | 2048x1080 | Yes <sup>1</sup>          | No     | Yes  | Yes     | Yes                              | Yes               | Yes             |
| UXGA                | 1600x1200 | Yes                       | No     | Yes  | No      | Yes                              | Yes               | Yes             |
| WUXGA               | 1920x1200 | Yes <sup>1</sup>          | No     | Yes  | Yes     | Yes                              | Yes               | Yes             |
| 1920x1440           | 1920x1440 | Undersampled <sup>2</sup> | No     | No   | Yes     | Yes                              | No                | Yes             |
| QXGA <sup>4</sup>   | 2048x1536 | Undersampled <sup>2</sup> | No     | No   | Yes     | Yes                              | No                | Yes             |
| 2560x1080           | 2560x1080 | No                        | No     | No   | No      | Yes                              | No                | Yes             |
| 2560x1440           | 2560x1440 | No                        | No     | No   | No      | No                               | No                | Yes             |
| WQXGA <sup>4</sup>  | 2560x1600 | No                        | No     | No   | No      | Yes                              | No                | Yes             |
| 2160p RGB           | 3840x2160 | No                        | No     | No   | Yes     | No                               | No                | No              |
| 4K RGB <sup>5</sup> | 4096x2160 | No                        | No     | No   | Yes     | No                               | No                | No              |

**Notes:**

- 1) Reduced Blanking
- 2) The signal is under-sampled: the image cannot be reproduced on 1:1 scaling (i.e. a 1920x1440 signal is under-sampled and then stretched horizontally to fit on a 1920x1440 image. The quality is not as good as it could be with a properly sampled signal)
- 3) 4-Lanes DisplayPort in version 1.1a (accept a Dual-Link DVI input via a non-supplied active adaptor)
- 4) Dual-Link format
- 5) 4K format, only available with the 4K option

## 4.7 Output specifications

### 4.7.1 Standard output

A **LiveCore™ unit** has two standard output modules.

The standard module contains two outputs with the following plugs:

- 3G/HD/SD-SDI (two clone outputs via 1 BNC and 1 dual video optical SFP module),
- Analog Computer/Video (HD15),
- DVI: Dual-Link DVI-I for output #1 and Single-Link DVI-I on output #2 (both with DVI-I connectors).

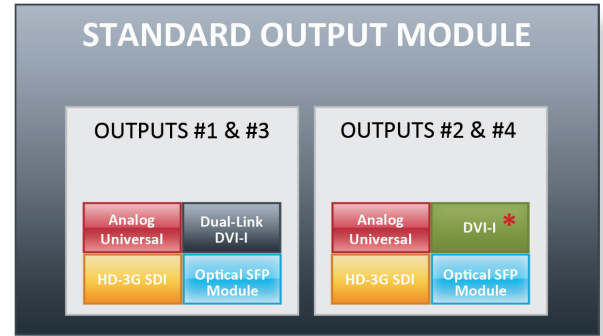

\* For devices with the optional 4K: DVI-I HDMI 4K

When using the standard output module for a Dual-link DVI connection, connect the display to output #1. Output #2 will not be available when outputting a Dual-link DVI connection.

**Only for all devices supporting 4K:**

When outputs #2 and #4 deliver 4K 30Hz format, output #1 and #3 are respectively disabled

**Only for 4RU devices supporting 4K:**

When outputs #2 delivers 4K 60Hz 4:2:0 format, all the other outputs are disabled

Please see the formats available on the output:

| Output Type                   | Format           | Signal                           |
|-------------------------------|------------------|----------------------------------|
| Analog Computer/Video Output  | HDTV<br>Computer | Analog HDTV<br>Analog Computer   |
| DVI-I Dual-Link Output        | HDTV<br>Computer | Digital HDTV<br>Digital Computer |
| 3G-SDI Output                 | HDTV             | Digital HDTV                     |
| Dual Video Optical SFP Module | HDTV             | Digital HDTV                     |

Please note that SDTV and EDTV are not available on the standard output module and require the monitoring output module.

### 4.7.2 Monitoring output

A **LiveCore™ unit** has one monitoring output module.

This module contains one output with the following plugs:

- 3G/HD/SD-SDI (2 x BNC),
- Analog Computer/Video (HD15),
- Dual-Link DVI-I (DVI-I),
- Analog SDTV (4 x BNC: Composite, YC, YUV, RGBS).

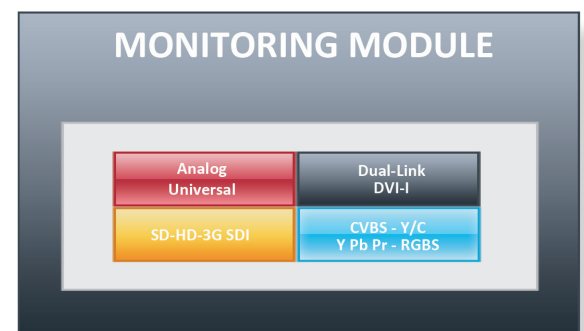

Please see the output formats of the monitoring output:

| Output Type                    | Format           | Signal                         |
|--------------------------------|------------------|--------------------------------|
| Video Y/C Output               | SDTV             | Analog SDTV                    |
| Video Y Pb Pr Output           | SDTV             | Analog SDTV                    |
| Video RGBSTTL Output           | SDTV             | Analog SDTV                    |
| Analog Computer / Video Output | SDTV             | Analog SDTV                    |
|                                | EDTV             | Analog EDTV                    |
|                                | HDTV<br>Computer | Analog HDTV<br>Analog Computer |
| DVI-I Dual-Link Output         | SDTV             | Digital SDTV                   |
|                                | EDTV             | Digital EDTV                   |
|                                | HDTV             | Digital HDTV                   |
|                                | Computer         | Digital Computer               |
| SD-HD-3G-SDI Output            | SDTV             | Digital SDTV                   |
|                                | HDTV             | Digital HDTV                   |

## 4.8 Communication specifications

### 4.8.1 Serial interface

A RS-232 compliant link is available through a DB-9 connector. This serial interface is reserved for factory purpose and communication with the **SPU001** external power mode.

| Link        | Baud rate                        |
|-------------|----------------------------------|
| RS-232 Link | Will depend on debug application |

### 4.8.2 LAN interface

A standard LAN interface is available through a RJ-45 connector (at 10/100/1000 Mbps)

- It permits controlling and updating the device
- It permits transferring Frames and Logos
- It permits transferring configuration and log files
- It permits connectivity with a web-client for the Web RCS application

### 4.8.3 Protocol

The **LiveCore™ unit** can be controlled by third party devices using dedicated Crestron, AMX modules or by sending ASCII strings which are documented in the TPP. For more information, see the «Programmer's Guide» section on our website.

| Protocol | Availability |
|----------|--------------|
| TCP      | Yes          |
| UDP      | No           |

### 4.8.4 IP address

The default network configuration for the **LiveCore™** devices is:

**DHCP: Disabled**

**IP address: 192.168.2.140**

**Subnet mask: 255.255.255.0**

**Gateway: 192.168.2.1**

| Address allocation          | Availability |
|-----------------------------|--------------|
| Static user defined address | Yes          |
| DHCP                        | Yes          |

For more information about connecting to the device, please see chapter 6.

### 4.8.5 USB host interface

In order to support a USB Host interface, a **LiveCore™ unit** is equipped with five A-type USB connectors:

- One is located on the front panel,
- Four are located on the rear panel.

These USB connectors are used to transfer updater files to the unit.

## 4.8.6 Compliance

This interface is fully compliant with USB 2.0 High Speed specification (up to 480 Mbps).

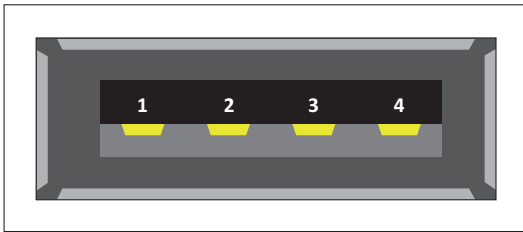

| Pin number | Function |
|------------|----------|
| 1          | 5V       |
| 2          | D-       |
| 3          | D+       |
| 4          | Ground   |

### SUPPORTED CLASSES

| Class             | Availability |
|-------------------|--------------|
| SCSI Mass Storage | Yes          |

## 4.9 Environmental specifications

### 4.9.1 Ascender 48 - 4K - PL

#### Dimensions:

- ▶ W 482 x D 552 x H 177 mm with rack mount and handles
- ▶ 19"W x 23.73"D x 6.97"H
- ▶ W 445 x D 552 x H 177 mm without rack mount and handles
- ▶ 17.52"W x 23.73"D x 6.97"H

#### Weight:

- ▶ 19,4 kg / 42.77 lbs  
(Compatible with a Standard 19" rack, Height = 4 U)

- Cooling air flows from front side to rear.
- Max ambient operating temperature: < 40°C (< 104°F).
- Operating temperature: 0 to +40°C / +32°F to +104°F
- Storage temperature: -40 to +70°C / -40°F to +158°F
- Operating humidity: 10 to 80% (non condensing)
- Input voltage range: 100-240 VAC autosensing, 50/60 Hz
- Typical consumption: **Ascender 48 - 4K - PL**: 405 W

#### ELECTRICAL SECURITY:

- IEC 60950-1:2005 (2nd Edition); Am 1:2009
- EN 60950-1:2006 + A1:2010 + A11:2009 + A12:2011, CSA C22.2; National Differences specified in the CB Test Report
- UL listed (Canada & US)

#### ELECTROMAGNETIC COMPATIBILITY:

- IEC 61000-3-2 (2009)
- IEC 61000-3-3 (2008)
- CISPR22 (2008)
- CISPR24 (2010)
- FCC Part15 of 2012
- IEC61000-3-2 of August 2012

#### ENVIRONMENT:

- RoHS
- WEEE

#### USE/TRANSPORT:

- ETS 300 019-2-2: Environmental conditions and environmental tests for telecommunications equipment ; Part 2-2 : specification of environmental tests ; Transportation ; Specification T 2.3: Public transportation
- ETS 300 019-2-3: Environmental conditions and environmental tests for telecommunications equipment ; Part 2-3 : specification of environmental tests ; Stationary use at weather protected locations ; Specification T 3.1 and T 3.1 E: Temperature-controlled locations



If your device should lose power unexpectedly, you may lose any unsaved settings.

## 4.9.2 Ascender 32 - 4K - PL

### Dimensions:

- ▶ W 482 x D 552 x H 177 mm with rack mount and handles
- ▶ 19"W x 23.73"D x 6.97"H
  
- ▶ W 445 x D 552 x H 177 mm without rack mount and handles
- ▶ 17.52"W x 23.73"D x 6.97"H

### Weight:

- ▶ 19 kg / 41.89 lbs  
(Compatible with a Standard 19" rack, Height = 4 U)

- Cooling air flows from front side to rear.
- Max ambient operating temperature: < 40°C (< 104°F).
- Operating temperature: 0 to +40°C / +32°F to +104°F
- Storage temperature: -40 to +70°C / -40°F to +158°F
- Operating humidity: 10 to 80% (non condensing)
- Input voltage range: 100-240 VAC autosensing, 50/60 Hz
- Typical consumption: **Ascender 32 - 4K -PL**: 345 W

### ELECTRICAL SECURITY:

- IEC 60950-1:2005 (2nd Edition); Am 1:2009
- EN 60950-1:2006 + A1:2010 + A11:2009 + A12:2011, CSA C22.2; National Differences specified in the CB Test Report
- UL listed (Canada & US)

### ELECTROMAGNETIC COMPATIBILITY:

- IEC 61000-3-2 (2009)
- IEC 61000-3-3 (2008)
- CISPR22 (2008)
- CISPR24 (2010)
- FCC Part15 of 2012
- IEC61000-3-2 of August 2012

### ENVIRONMENT:

- RoHS
- WEEE

### USE/TRANSPORT:

- ETS 300 019-2-2: Environmental conditions and environmental tests for telecommunications equipment ; Part 2-2 : specification of environmental tests ; Transportation ; Specification T 2.3: Public transportation
- ETS 300 019-2-3: Environmental conditions and environmental tests for telecommunications equipment ; Part 2-3 : specification of environmental tests ; Stationary use at weather protected locations ; Specification T 3.1 and T 3.1 E: Temperature-controlled locations



If your device should lose power unexpectedly, you may lose any unsaved settings.



### 4.9.3 Ascender 16 - 4K

#### Dimensions:

- ▶ W 482 x D 544 x H 177 mm with rack mount and handles
- ▶ 19"W x 23.73"D x 6.97"H
- ▶ W 445 x D 544 x H 177 mm without rack mount and handles
- ▶ 17.52"W x 23.73"D x 6.97"H

#### Weight:

- ▶ 19 kg / 41.89 lbs  
(Compatible with a Standard 19" rack, Height = 4 U)

- Cooling air flows from front side to rear.
- Max ambient operating temperature: < 40°C (< 104°F).
- Operating temperature: 0 to +40°C / +32°F to +104°F
- Storage temperature: -40 to +70°C / -40°F to +158°F
- Operating humidity: 10 to 80% (non condensing)
- Input voltage range: 100-240 VAC autosensing, 50/60 Hz
- Typical consumption: **Ascender 16 - 4K**: 285 W

#### ELECTRICAL SECURITY:

- IEC 60950-1:2005 (2nd Edition); Am 1:2009
- EN 60950-1:2006 + A1:2010 + A11:2009 + A12:2011, CSA C22.2; National Differences specified in the CB Test Report
- UL listed (Canada & US)

#### ELECTROMAGNETIC COMPATIBILITY:

- IEC 61000-3-2 (2009)
- IEC 61000-3-3 (2008)
- CISPR22 (2008)
- CISPR24 (2010)
- FCC Part15 of 2012
- IEC61000-3-2 of August 2012

#### ENVIRONMENT:

- RoHS
- WEEE

#### USE/TRANSPORT:

- ETS 300 019-2-2: Environmental conditions and environmental tests for telecommunications equipment ; Part 2-2 : specification of environmental tests ; Transportation ; Specification T 2.3: Public transportation
- ETS 300 019-2-3: Environmental conditions and environmental tests for telecommunications equipment ; Part 2-3 : specification of environmental tests ; Stationary use at weather protected locations ; Specification T 3.1 and T 3.1 E: Temperature-controlled locations



If your device should lose power unexpectedly, you may lose any unsaved settings.

## 4.9.4 SmartMatrix Ultra

**Dimensions:**

- ▶ W 482 x D 544 x H 177 mm with rack mount and handles
- ▶ 19"W x 23.73"D x 6.97"H
- ▶ W 445 x D 544 x H 177 mm without rack mount and handles
- ▶ 17.52"W x 23.73"D x 6.97"H

**Weight:**

- ▶ 19 kg / 41.89 lbs  
(Compatible with a Standard 19" rack, Height = 4 U)

- Cooling air flows from front side to rear.
- Max ambient operating temperature: < 40°C (< 104°F).
- Operating temperature: 0 to +40°C / +32°F to +104°F
- Storage temperature: -40 to +70°C / -40°F to +158°F
- Operating humidity: 10 to 80% (non condensing)
- Input voltage range: 100-240 VAC autosensing, 50/60 Hz
- Typical consumption: **SmartMatrix Ultra**: 285 W

**ELECTRICAL SECURITY:**

- IEC 60950-1:2005 (2nd Edition); Am 1:2009
- EN 60950-1:2006 + A1:2010 + A11:2009 + A12:2011, CSA C22.2; National Differences specified in the CB Test Report
- UL listed (Canada & US)

**ELECTROMAGNETIC COMPATIBILITY:**

- IEC 61000-3-2 (2009)
- IEC 61000-3-3 (2008)
- CISPR22 (2008)
- CISPR24 (2010)
- FCC Part15 of 2012
- IEC61000-3-2 of August 2012

**ENVIRONMENT:**

- RoHS
- WEEE

**USE/TRANSPORT:**

- ETS 300 019-2-2: Environmental conditions and environmental tests for telecommunications equipment ; Part 2-2 : specification of environmental tests ; Transportation ; Specification T 2.3: Public transportation
- ETS 300 019-2-3: Environmental conditions and environmental tests for telecommunications equipment ; Part 2-3 : specification of environmental tests ; Stationary use at weather protected locations ; Specification T 3.1 and T 3.1 E: Temperature-controlled locations



If your device should lose power unexpectedly, you may lose any unsaved settings.

## 4.9.5 NeXtage 16 - 4K

### Dimensions:

- ▶ W 482 x D 544 x H 133 mm with rack mount and handles
- ▶ 19"W x 21.41"D x 6.97"H
- ▶ W 445 x D 544 x H 133 mm without rack mount and handles
- ▶ 17.52"W x 21.41"D x 6.97"H

### Weight:

- ▶ 15,1 kg / 33.29 lbs  
(Compatible with a Standard 19" rack, Height = 3 U)

- Cooling air flows from front side to rear.
- Max ambient operating temperature: < 40°C (< 104°F).
- Operating temperature: 0 to +40°C / +32°F to +104°F
- Storage temperature: -40 to +70°C / -40°F to +158°F
- Operating humidity: 10 to 80% (non condensing)
- Input voltage range: 100-240 VAC autosensing, 50/60 Hz
- Typical consumption: **NeXtage 16 - 4K**: 240W

### ELECTRICAL SECURITY:

- IEC 60950-1:2005 (2nd Edition); Am 1:2009
- EN 60950-1:2006 + A1:2010 + A11:2009 + A12:2011, CSA C22.2; National Differences specified in the CB Test Report
- UL listed (Canada & US)

### ELECTROMAGNETIC COMPATIBILITY:

- IEC 61000-3-2 (2009)
- IEC 61000-3-3 (2008)
- CISPR22 (2008)
- CISPR24 (2010)
- FCC Part15 of 2012
- IECS-003 of August 2012

### ENVIRONMENT:

- RoHS
- WEEE

### USE/TRANSPORT:

- ETS 300 019-2-2: Environmental conditions and environmental tests for telecommunications equipment ; Part 2-2 : specification of environmental tests ; Transportation ; Specification T 2.3: Public transportation
- ETS 300 019-2-3: Environmental conditions and environmental tests for telecommunications equipment ; Part 2-3 : specification of environmental tests ; Stationary use at weather protected locations ; Specification T 3.1 and T 3.1 E: Temperature-controlled locations



If your device should lose power unexpectedly, you may lose any unsaved settings.

## 4.9.6 NeXtage 08 - 4K

### Dimensions:

- ▶ W 482 x D 544 x H 133 mm with rack mount and handles
- ▶ 19"W x 21.41"D x 6.97"H
  
- ▶ W 445 x D 544 x H 133 mm without rack mount and handles
- ▶ 17.52"W x 21.41"D x 6.97"H

### Weight:

- ▶ 14,8 kg / 32.63 lbs  
(Compatible with a Standard 19" rack, Height = 3 U)

- Cooling air flows from front side to rear.
- Max ambient operating temperature: < 40°C (< 104°F).
- Operating temperature: 0 to +40°C / +32°F to +104°F
- Storage temperature: -40 to +70°C / -40°F to +158°F
- Operating humidity: 10 to 80% (non condensing)
- Input voltage range: 100-240 VAC autosensing, 50/60 Hz
- Typical consumption: **NeXtage 08 - 4K**: 225 W

### ELECTRICAL SECURITY:

- IEC 60950-1:2005 (2nd Edition); Am 1:2009
- EN 60950-1:2006 + A1:2010 + A11:2009 + A12:2011, CSA C22.2; National Differences specified in the CB Test Report
- UL listed (Canada & US)

### ELECTROMAGNETIC COMPATIBILITY:

- IEC 61000-3-2 (2009)
- IEC 61000-3-3 (2008)
- CISPR22 (2008)
- CISPR24 (2010)
- FCC Part15 of 2012
- IECS-003 of August 2012

### ENVIRONMENT:

- RoHS
- WEEE

### USE/TRANSPORT:

- ETS 300 019-2-2: Environmental conditions and environmental tests for telecommunications equipment ; Part 2-2 : specification of environmental tests ; Transportation ; Specification T 2.3: Public transportation
- ETS 300 019-2-3: Environmental conditions and environmental tests for telecommunications equipment ; Part 2-3 : specification of environmental tests ; Stationary use at weather protected locations ; Specification T 3.1 and T 3.1 E: Temperature-controlled locations



If your device should lose power unexpectedly, you may lose any unsaved settings.

## 4.9.7 LiveCore™ Output Expander - Ref. LOE048-4K-PL, LOE032-4K-PL, LOE016-4K

**Dimensions:**

- ▶ W 482 x D 552 x H 177 mm with rack mount and handles
- ▶ 19"W x 23.73"D x 6.97"H
- ▶ W 445 x D 544 x H 177 mm without rack mount and handles
- ▶ 17.52"W x 21.41"D x 6.97"H

**Weight:**

- ▶ 18,4 kg / 40.56 lbs  
(Compatible with a Standard 19" rack, Height = 4 U)

- Cooling air flows from front side to rear.
- Max ambient operating temperature: < 40°C (< 104°F).
- Operating temperature: 0 to +40°C / +32°F to +104°F
- Storage temperature: -40 to +70°C / -40°F to +158°F
- Operating humidity: 10 to 80% (non condensing)
- Input voltage range: 100-240 VAC autosensing, 50/60 Hz
- Typical consumption: **LiveCore™ Output Expander: 285 W**

**ELECTRICAL SECURITY:**

- IEC 60950-1:2005 (2nd Edition); Am 1:2009
- EN 60950-1:2006 + A1:2010 + A11:2009 + A12:2011, CSA C22.2; National Differences specified in the CB Test Report
- UL listed (Canada & US)

**ELECTROMAGNETIC COMPATIBILITY:**

- IEC 61000-3-2 (2009)
- IEC 61000-3-3 (2008)
- CISPR22 (2008)
- CISPR24 (2010)
- FCC Part15 of 2012
- IEC61000-3-2 of August 2012

**ENVIRONMENT:**

- RoHS
- WEEE

**USE/TRANSPORT:**

- ETS 300 019-2-2: Environmental conditions and environmental tests for telecommunications equipment ; Part 2-2 : specification of environmental tests ; Transportation ; Specification T 2.3: Public transportation
- ETS 300 019-2-3: Environmental conditions and environmental tests for telecommunications equipment ; Part 2-3 : specification of environmental tests ; Stationary use at weather protected locations ; Specification T 3.1 and T 3.1 E: Temperature-controlled locations



If your device should lose power unexpectedly, you may lose any unsaved settings.

## 4.10 HDCP management

### 4.10.1 Input HDCP detection

The input HDCP detection is managed by the input components according to HDCP specification.

### 4.10.2 Output HDCP detection

**LiveCore™ unit** manages the output HDCP detection according to one of the following criteria:

- Hot plug,
- 3-second period attempt.

### 4.10.3 Keys' checking

Keys' checking is performed according to the most restrictive condition among the 2 following ones:

- Every 2 seconds
- Every 128 frames

### 4.10.4 Output management

HDCP protected content can be displayed only on HDCP protected outputs or displays. Therefore, whenever an HDCP protected source is placed into a layer routed to a non-protected output, **LiveCore™ unit** will not output the protected content on this non-protected output, and the layer will be muted.

If possible, **LiveCore™ unit** will allow displaying all other non-protected contents, otherwise the entire output will be muted until the protected content is no longer routed to the affected output. *See chapter 12. Applications note and tips for more information.*

### 4.10.5 HDCP Classification

| Class            | Support |
|------------------|---------|
| HDCP Receiver    | Yes     |
| HDCP Transmitter | Yes     |
| HDCP Repeater    | No      |

#### HDCP Receiver

The HDCP negotiation can be enabled or disabled on all HDCP inputs.

#### HDCP Transmitter

The HDCP negotiation can be enabled or disabled on all HDCP outputs.

**LiveCore™ unit** can manage HDCP repeaters on its outputs: up to 48 display devices can authenticate simultaneously on each output.

### 4.10.6 Status

In order to permit quick identification of all the HDCP operations on the device, **LiveCore™ unit** provides a full set of status summary to help the user with the HDCP management:

- A front panel menu that displays all the general HDCP status of all inputs and outputs
- On the monitoring output, the HDCP status of each input will be indicated.

## 5. CONNECTING A LIVECORE™ UNIT

### 5.1.1 Rear panel of 4RU LiveCore™ unit

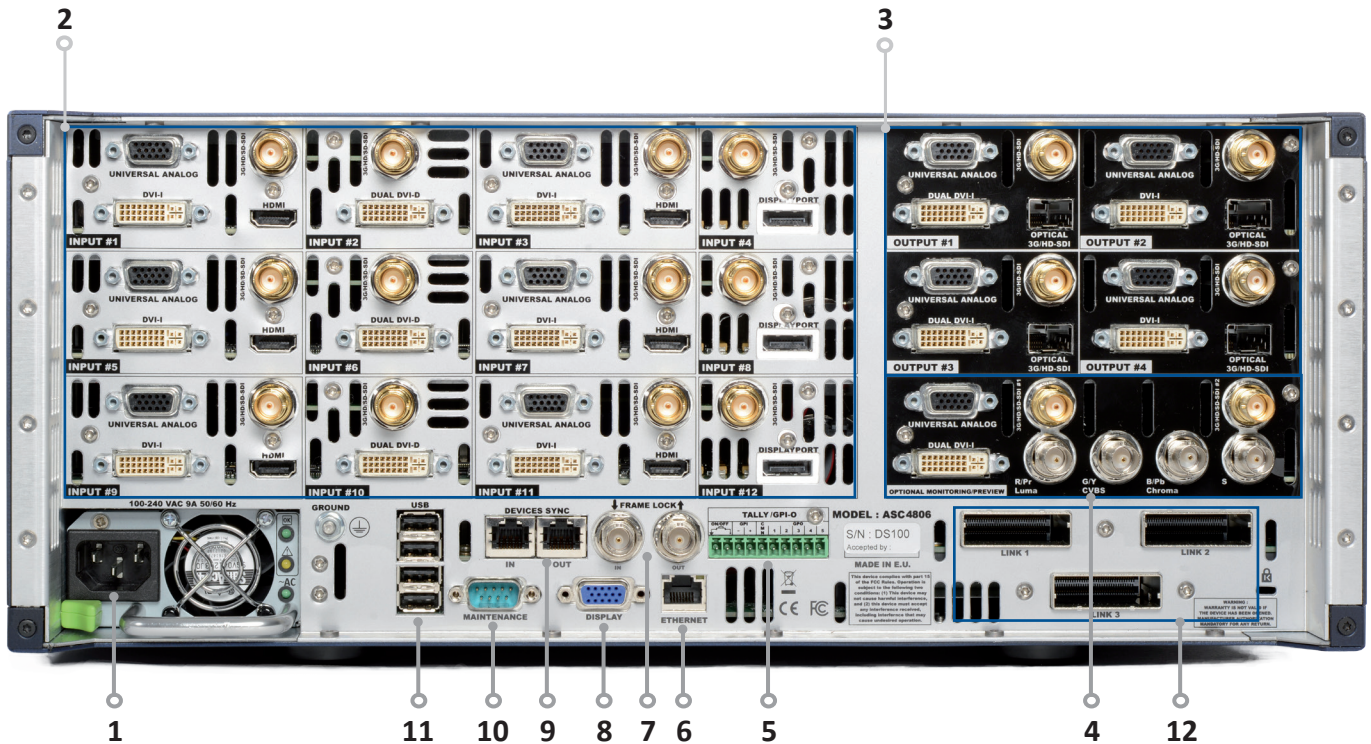

**1. Power supply:** internal, autoswitching ; Typical consumption: **Ascender 48 - 4K - PL:** 405W / **Ascender 32 - 4K - PL:** 345W / **Ascender 16 - 4K:** 285W / **SmartMatrix Ultra:** 285W ;

**2. Inputs #1 to #12:**

- 6 x HDMI
- 9 x DVI (6 x DVI-I & 3 x DVI-D / Dual link available on Inputs #2, #6 and #10)
- 3 x DisplayPort (Dual link available on Inputs #4, #8 & #12 )
- 12 x 3G/HD/SD-SDI
- 12 x Universal Analog (6 x HD15 & 6 x DVI-A)

**3. Outputs #1, #2, #3 & #4:**

- 8 x Universal Analog (4 x HD15 & 4 x DVI-A)
- 4 x DVI-I (DVI Dual-Link on outputs #1 & #3)
- 4 x Video Optical SFP module cage
- 4 x 3G/HD/SD-SDI

**4. Monitoring/Preview output:**

- 2 x Universal Analog (HD15 & DVI-A)
- 1 x DVI-I
- 2 x 3G/HD/SD-SDI
- 1 x RGBs/RGsB/RGB/YPrBr/YC/composite analog output

**5. Tally, GPI-O connector**

**6. Ethernet plug**

**7. Frame Lock:** Analog Frame Lock plug and loop output

**8. Display output (not active)**

**9. Devices sync.:** Used for synchronizing multiple devices in multi-machine mode.

**10. RS232 port:** Reserved for maintenance and SPU001 connection

**11. 4 x USB plugs**

**12. Link cables:** Use the 3 link cables to share inputs/outputs in the additive modularity configuration.

## 5.1.2 Rear panel of 4RU LiveCore™ unit - 4K option

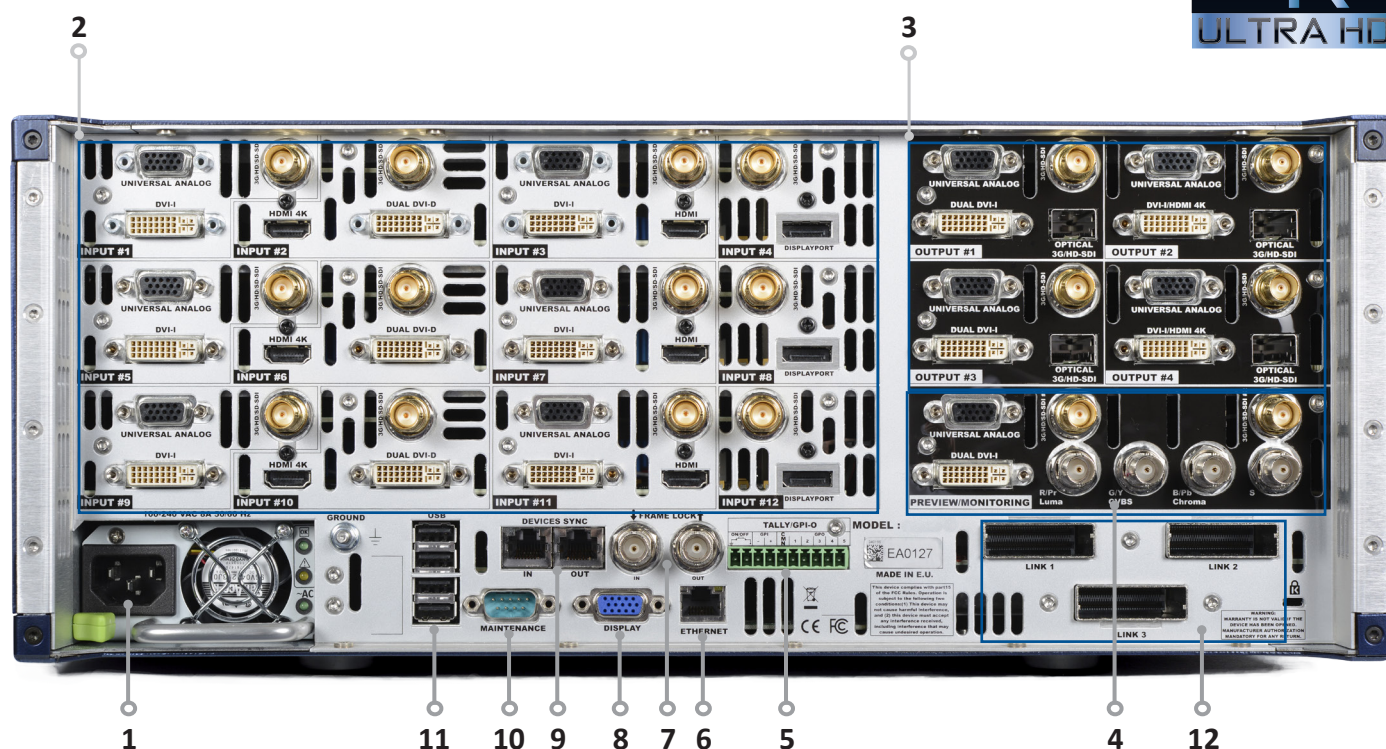

**1. Power supply:** internal, autoswitching ; Typical consumption: **Ascender 48 - 4K - PL:** 405W / **Ascender 32 - 4K - PL:** 345W / **Ascender 16 - 4K:** 285W / **SmartMatrixX Ultra:** 285W ;

**2. Inputs #1 to #12:**

- 6 x HDMI (4K available on inputs #2, #6 and #10)
- 9 x DVI (6 x DVI-I & 3 x DVI-D / Dual link available on Inputs #2, #6 and #10)
- 3 x DisplayPort (Dual link available on Inputs #4, #8 & #12 )
- 12 x 3G/HD/SD-SDI
- 12 x Universal Analog (6 x HD15 & 6 x DVI-A)

**3. Outputs #1, #2, #3 & #4:**

- 8 x Universal Analog (4 x HD15 & 4 x DVI-A)
- 4 x DVI-I (DVI Dual-Link on outputs #1 & #3, DVI/HDMI 4K on outputs #2 & #4)
- 4 x Video Optical SFP module cage
- 4 x 3G/HD/SD-SDI

**4. Monitoring/Preview output:**

- 2 x Universal Analog (HD15 & DVI-A)
- 1 x DVI-I
- 2 x 3G/HD/SD-SDI
- 1 x RGBs/RGsB/RGB/YPrBr/YC/composite analog output

**5. Tally, GPI-O connector**

**6. Ethernet plug**

**7. Frame Lock:** Analog Frame Lock plug and loop output

**8. Display output (not active)**

**9. Devices sync.:** Used for synchronizing multiple devices in multi-machine mode.

**10. RS232 port:** Reserved for maintenance and SPU001 connection

**11. 4 x USB plugs**

**12. Link cables:** Use the 3 link cables to share inputs/outputs in the additive modularity configuration.



## 5.1.3 Rear panel of 3RU LiveCore™ - 4K

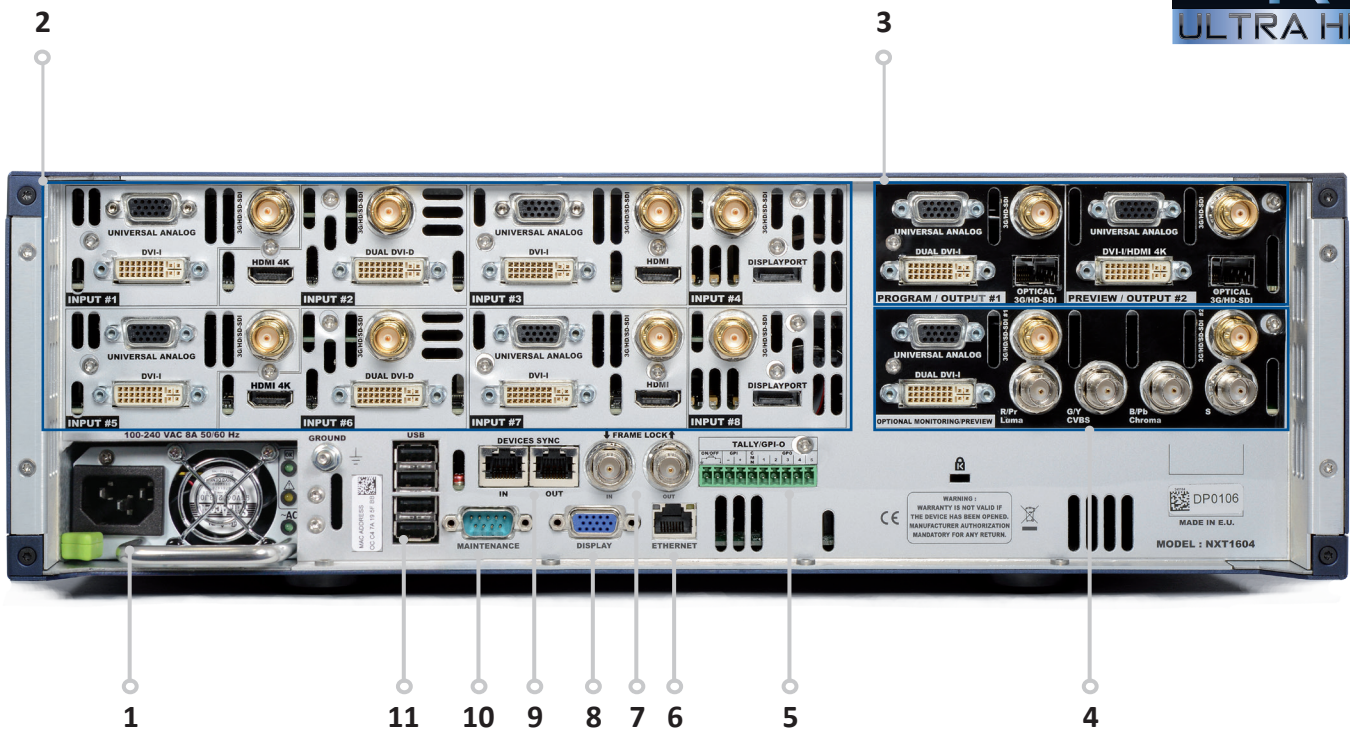

**1. Removable Power supply:** 100-240 VAC 8A 50/60Hz, 240W

**2. Inputs #1 to #8:**

- 4 x HDMI (4K available on inputs #2 and #6)
- 6 x DVI-I (Dual link available on Inputs #2 and #6)
- 2 x DisplayPort (Dual link available on Inputs #4 and #8)
- 8 x 3G/HD/SD-SDI
- 8 x Universal Analog(4 x HD15 & 4 x DVI-A)

**3. Program output #1 - Preview output #2:**

- 2 x Universal Analog (HD15 & DVI-A)
- 2 x DVI-I (DVI Dual-Link on output #1, DVI/HDMI 4K on output #2)
- 2 x Video Optical SFP module cage
- 3G/HD/SD-SDI

**4. Preview/Monitoring:**

- 1 x Universal Analog (HD15 & DVI-A)
- 1 x DVI-I
- 2 x 3G/HD/SD-SDI
- 1 x RGBs analog output

**5. Tally, GPI-O connector**

**6. Ethernet plug**

**7. Frame Lock:** Analog Frame Lock plug and loop output

**8. Display output (not active)**

**9. Devices sync.:** Used for synchronizing multiple devices in multi-machine mode.

**10. RS232 port:** Reserved for maintenance and SPU001 connection

**11. 4 x USB plugs**

## 5.1.4 Rear panel of a LiveCore™ Output Expander

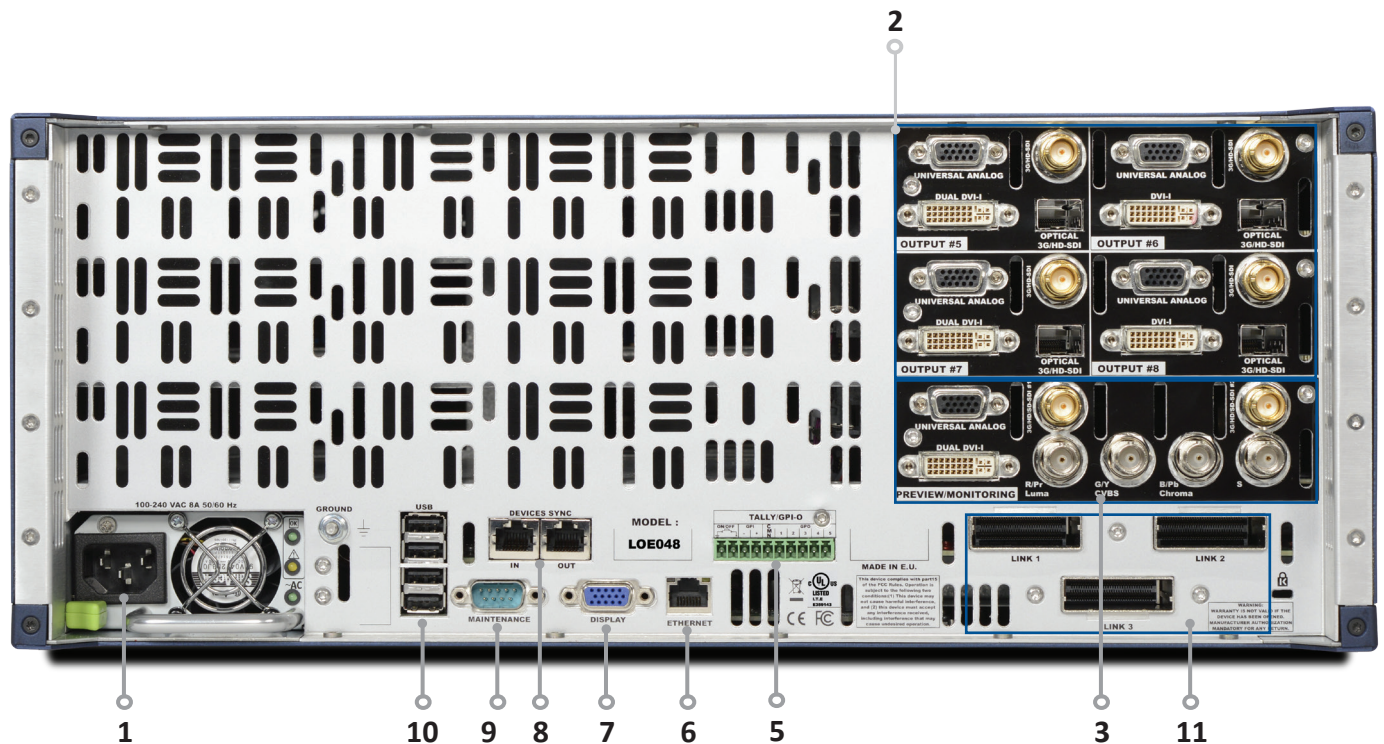

**1. Power supply:** internal, autoswitching ; Typical consumption: 405W

**2. Outputs #5, #6, #7 & #8:**

- 8 x Universal Analog (4 x HD15 & 4 x DVI-A)
- 4 x DVI-I (DVI Dual-Link on outputs #5 & #7, **4K option:** DVI/HDMI 4K on outputs #6 & #8)
- 4 x Video Optical SFP module cage
- 4 x 3G/HD/SD-SDI

**3. Monitoring/Preview output:**

- 2 x Universal Analog (HD15 & DVI-A)
- 1 x DVI-I
- 2 x 3G/HD/SD-SDI
- 1 x RGBs/RGsB/RGB/YPrBr/YC/composite analog output

**5.** Tally, GPI-O connector

**6.** Ethernet plug

**7.** Display output (not active)

**8. Devices sync.:** Used for synchronizing multiple devices in multi-machine mode.

**9. RS232 port:** Reserved for maintenance and SPU001 connection

**10.** 4 x USB plugs

**11. Link cables:** Use the 3 link cables to share inputs/outputs in the additive modularity configuration.

## 5.1.5 Front panel of Ascender 48 - 4K - PL

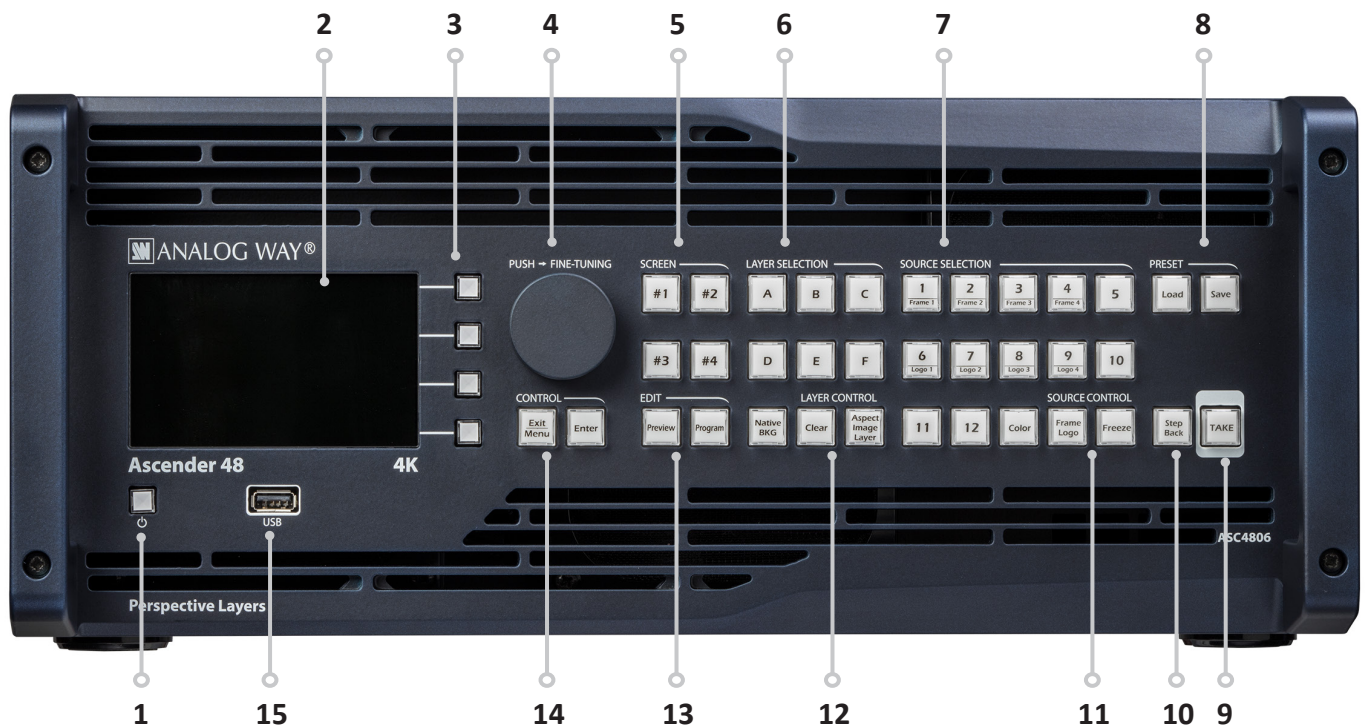

1. **On/Off - Stand-by:** Push the button then use the contextual button to enter in stand-by mode
2. 4,3" TFT color display (with WVGA resolution)
3. Contextual buttons
4. Menu scroll knob
5. **Screen: #1 to #4:** select a screen
6. **Layer selection: Native Background:** not scaled layer - **A/B/C/D/E/F:** scaled layers
7. **Source selection: Input #1 to #12:** access Frame #1 to #4 or Logo #1 to #4 - **Color:** fill in a layer with a color
8. **Preset: Load:** load a preset - **Save:** save a preset
9. **TAKE:** Transition the pre-selected sources onto the Program output with the selected effects
10. **Step Back:** Recall the last preset into your Preview monitor
11. **Source control: Frame logo:** press before selecting the Logo/Frame number - **Freeze:** freeze the input linked to the current layer on the Program
12. **Layer control: Clear:** clear a layer - **Aspect Image Layer:** adjust Layer properties
13. **Edit: Program:** edit Program - **Preview:** edit Preview
14. **Control: Exit/Menu:** Home menu or back one level - **Enter:** validate the menu or command
15. USB plug

## 5.1.6 Front panel of Ascender 32 - 4K - PL

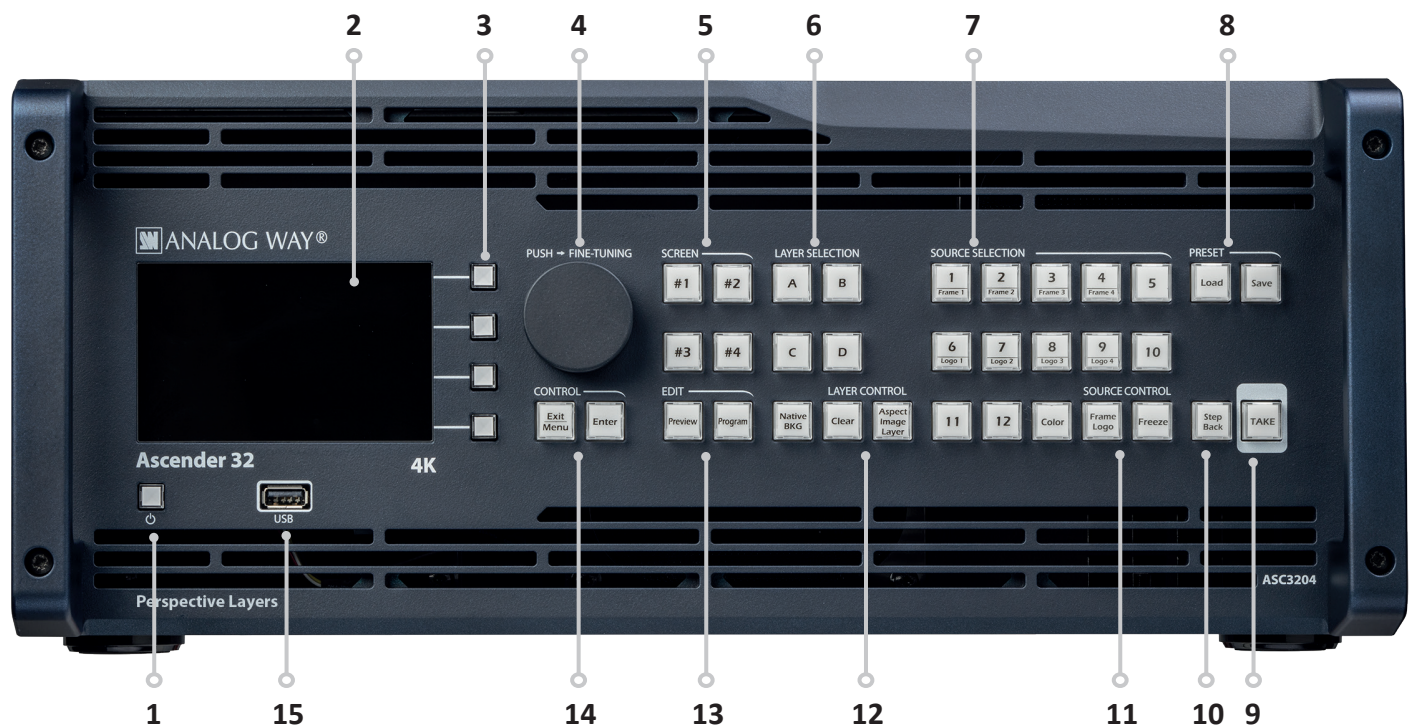

1. **On/Off - Stand-by:** Push the button then use the contextual button to enter in stand-by mode
2. 4,3'' TFT color display (with WVGA resolution)
3. Contextual buttons
4. Menu scroll knob
5. **Screen: #1 to #4:** select a screen
6. **Layer selection: Native Background:** not scaled layer - **A/B/C/D:** scaled layers
7. **Source selection: Input #1 to #12:** access Frame #1 to #4 or Logo #1 to #4 - **Color:** fill in a layer with a color
8. **Preset: Load:** load a preset - **Save:** save a preset
9. **TAKE:** Transition the pre-selected sources onto the Program output with the selected effects
10. **Step Back:** Recall the last preset into your Preview monitor
11. **Source control: Frame logo:** press before selecting the Logo/Frame number - **Freeze:** freeze the input linked to the current layer on the Program
12. **Layer control: Clear:** clear a layer - **Aspect Image Layer:** adjust Layer properties
13. **Edit: Program:** edit Program - **Preview:** edit Preview
14. **Control: Exit/Menu:** Home menu or back one level - **Enter:** validate the menu or command
15. USB plug

## 5.1.7 Front panel of Ascender 16 - 4K

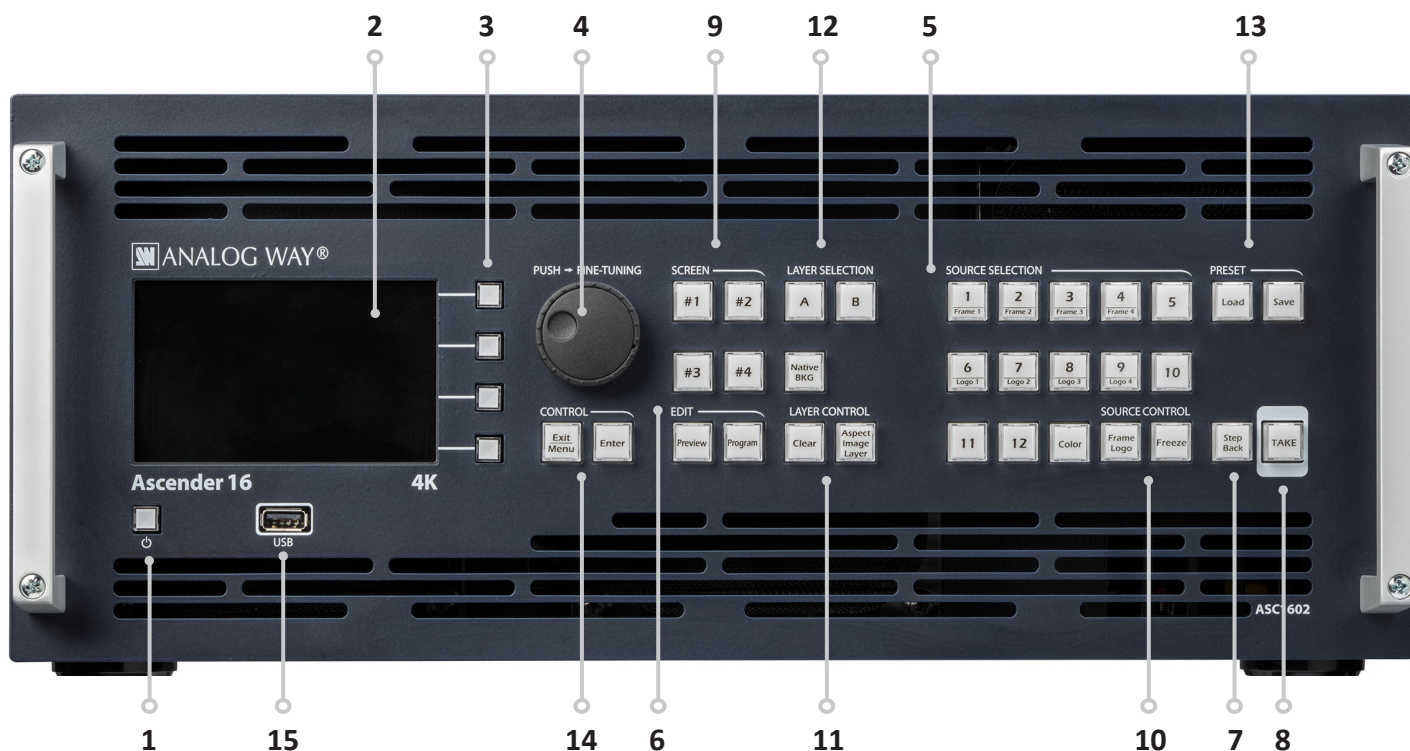

1. **On/Off - Stand-by:** Push the button then use the contextual button to enter in stand-by mode
2. 4,3'' TFT color display (with WVGA resolution)
3. Contextual buttons
4. Menu scroll knob
5. **Source selection:** **Input #1 to #12:** access Frame #1 to #4 or Logo #1 to #4 - **Color:** fill in a layer with a color
6. **Edit:** **Program:** edit Program - **Preview:** edit Preview
7. **Step Back:** Recall the last preset into your Preview monitor
8. **TAKE:** Transition the pre-selected sources onto the Program output with the selected effects
9. **Screen:** **#1 to #4:** select a screen
10. **Source control:** **Frame logo:** press before selecting the Logo/Frame number - **Freeze:** freeze the input linked to the current layer on the Program
11. **Layer control:** **Clear:** clear a layer - **Aspect Image Layer:** adjust Layer properties
12. **Layer selection:** **Native Background:** not scaled layer - **A/B:** scaled layers
13. **Preset:** **Load:** load a preset - **Save:** save a preset
14. **Control:** **Exit/Menu:** Home menu or back one level - **Enter:** validate the menu or command
15. USB plug

## 5.1.8 Front panel of SmartMatrix Ultra

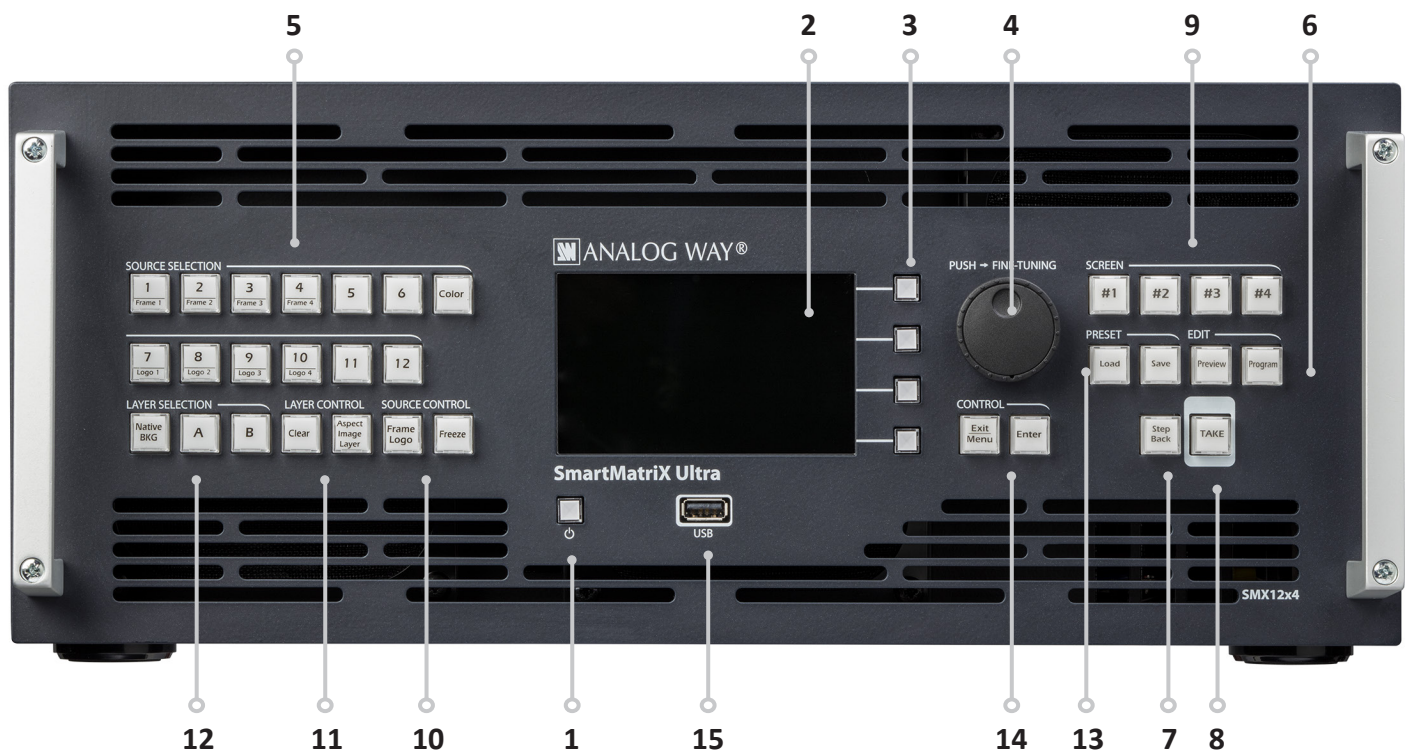

1. **On/Off - Stand-by:** Push the button then use the contextual button to enter in stand-by mode
2. 4,3" TFT color display (with WVGA resolution)
3. Contextual buttons
4. Menu scroll knob
5. **Source selection:** **Input #1 to #12:** access Frame #1 to #4 or Logo #1 to #4 - **Color:** fill in a layer with a color
6. **Edit: Program:** edit Program - **Preview:** edit Preview
7. **Step Back:** Recall the last preset into your Preview monitor
8. **TAKE:** Transition the pre-selected sources onto the Program output with the selected effects
9. **Screen: #1 to #4:** select a screen
10. **Source control: Frame logo:** press before selecting the Logo/Frame number - **Freeze:** freeze the input linked to the current layer on the Program
11. **Layer control: Clear:** clear a layer - **Aspect Image Layer:** adjust Layer properties
12. **Layer selection: Native Background:** not scaled layer - **A/B:** scaled layers
13. **Preset: Load:** load a preset - **Save:** save a preset
14. **Control: Exit/Menu:** Home menu or back one level - **Enter:** validate the menu or command
15. USB plug

Please note that for 4K devices, the reference 4K is affixed below the front display.

## 5.1.9 Front panel of NeXtage 16 - 4K

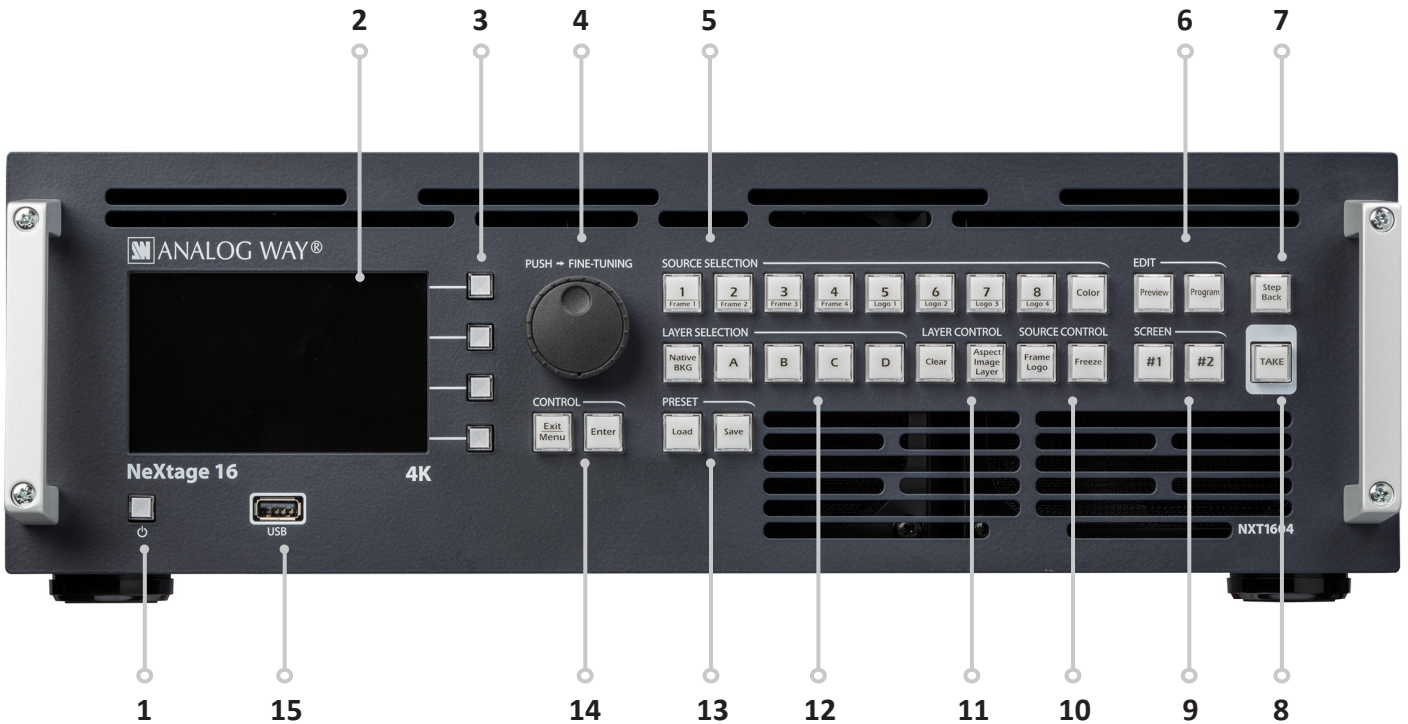

1. **On/Off - Stand-by:** Push the button then use the contextual button to enter in stand-by mode
2. 4,3'' TFT color display (with WVGA resolution)
3. Contextual buttons
4. Menu scroll knob
5. **Source selection:** **Input #1 to #8:** access Frame #1 to #4 or Logo #5 to #8 - **Color:** fill in a layer with a color
6. **Edit:** **Program:** edit Program - **Preview:** edit Preview
7. **Step Back:** Recall the last preset into your Preview monitor
8. **TAKE:** Transition the pre-selected sources onto the Program output with the selected effects
9. **Screen:** **#1 to #2:** select a screen
10. **Source control:** **Frame logo:** press before selecting the Logo/Frame number - **Freeze:** freeze the input linked to the current layer on the Program
11. **Layer control:** **Clear:** clear a layer - **Aspect Image Layer:** adjust Layer properties
12. **Layer selection:** **Native Background:** not scaled layer - **A/B/C/D:** scaled layers
13. **Preset:** **Load:** load a preset - **Save:** save a preset
14. **Control:** **Exit/Menu:** Home menu or back one level - **Enter:** validate the menu or command
15. USB plug

## 5.1.10 Front panel of NeXtage 08 - 4K

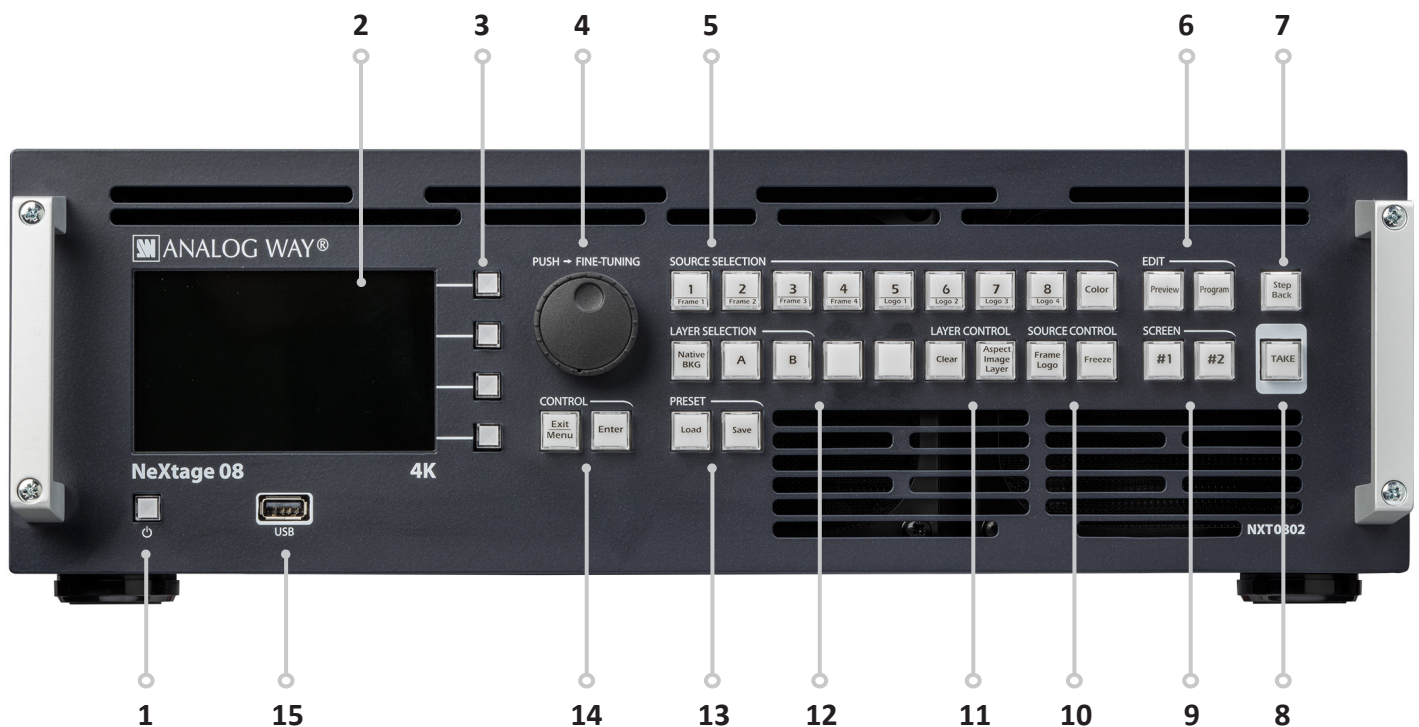

1. **On/Off - Stand-by:** Push the button then use the contextual button to enter in stand-by mode
2. 4,3" TFT color display (with WVGA resolution)
3. Contextual buttons
4. Menu scroll knob
5. **Source selection:** **Input #1 to #8:** access Frame #1 to #4 or Logo #5 to #8 - **Color:** fill in a layer with a color
6. **Edit:** **Program:** edit Program - **Preview:** edit Preview
7. **Step Back:** Recall the last preset into your Preview monitor
8. **TAKE:** Transition the pre-selected sources onto the Program output with the selected effects
9. **Screen:** **#1 to #2:** select a screen
10. **Source control:** **Frame logo:** press before selecting the Logo/Frame number - **Freeze:** freeze the input linked to the current layer on the Program
11. **Layer control:** **Clear:** clear a layer - **Aspect Image Layer:** adjust Layer properties
12. **Layer selection:** **Native Background:** not scaled layer - **A/B:** scaled layers
13. **Preset:** **Load:** load a preset - **Save:** save a preset
14. **Control:** **Exit/Menu:** Home menu or back one level - **Enter:** validate the menu or command
15. USB plug



## 5.1.11 Front panel of a LiveCore™ Output Expander

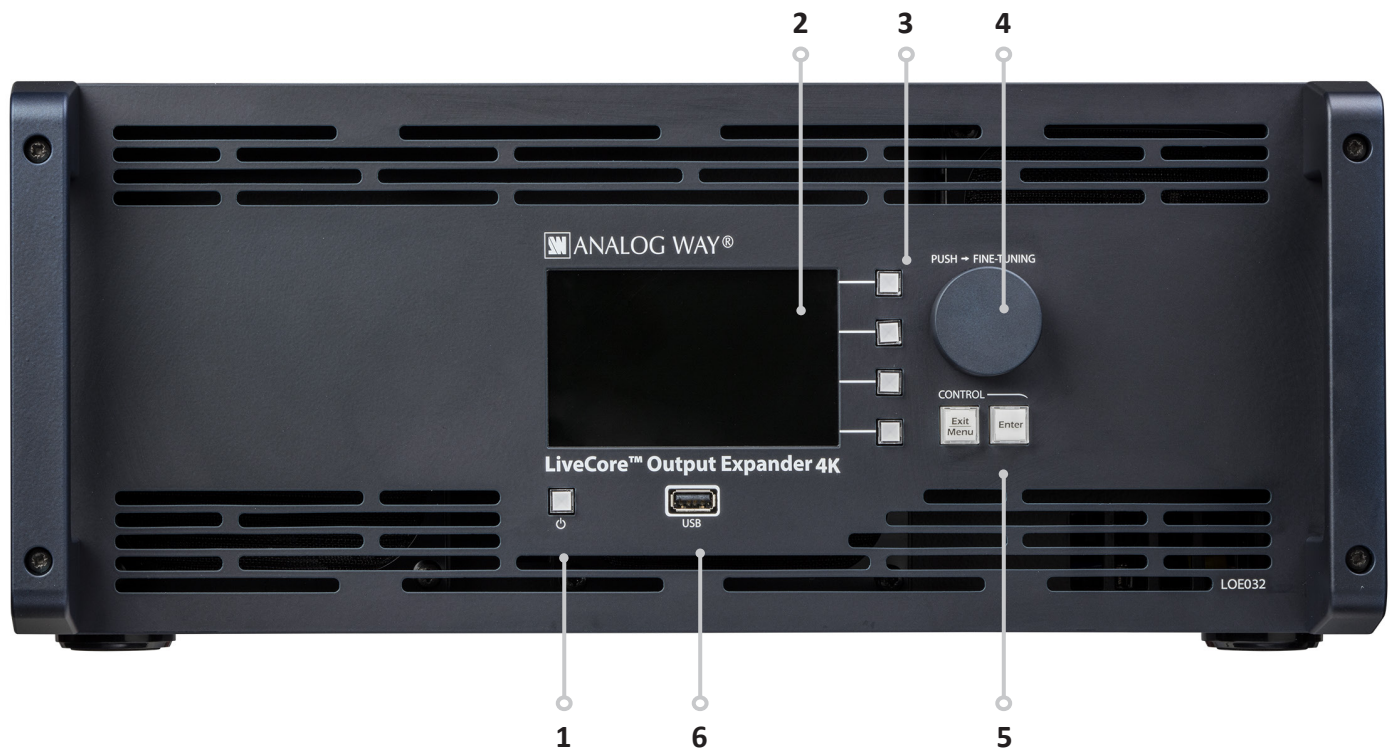

1. **On/Off - Stand-by:** Push the button then use the contextual button to enter in stand-by mode
2. 4,3" TFT color display (with WVGA resolution)
3. Contextual buttons
4. Menu scroll knob
5. **Control: Exit/Menu:** Home menu or back one level - **Enter:** validate the menu or command
6. USB plug

Please note that for Perspective Layers devices, the reference 4K-PL is affixed on the left side of the product.

## 6. CONTROLLING A LIVECORE™ UNIT

### 6.1 Web-based RCS requirement

A **LiveCore™ unit** can be controlled and operated either via the Front Panel, from your computer via the **Web RCS**, or via one or our Event Controllers. (Control of the **LiveCore™ unit** can also be integrated into automation and control systems, contact your local technical support for more details.)

#### The recommended requirements are:

- Adobe Flash® player 11.3
- 1Gb Ram
- 200Mb of free space
- 100Mb Network adaptor or above
- 1920x1080 optimized screen resolution
- 1366x768 as the minimum screen resolution.

The Web RCS has been optimized for Chrome web browser in full screen mode.

Please note that your browser and Flash Player had to be updated frequently, depending on new available versions.

#### Operating system:

- Windows XP SP3 or above
- Mac OS v10.7 or above
- Ubuntu v10 or above
- Linux OS 11 or above

#### Web browser:

- IE v10 or above
- Chrome v32 or above
- Firefox v22 or above
- Safari v6 or above
- Opera v10 or above

### 6.2 Connecting with the Web RCS



To be connected, you need to use a LAN connection. Use a crossover cable if you connect your computer directly to the unit, or use straight cables if you are connecting through a switch or hub.

Before switching ON the unit, please plug a LAN cable on the rear panel into the Ethernet port. Then switch ON the unit.

By default, the network settings on the **LiveCore™ unit** are

**Default IP Address: 192.168.2.140**

**Default Subnet Mask: 255.255.255.0**

**Default port: 80**

**Please be sure that ports 80, 843 and 4521 are available.**

To be able to connect to this address, your computer will need to be configured to use a unique IP address on the same network. If this setup is part of a larger network with other devices, please check with your network administrator before plugging these devices into the network to avoid any IP address conflicts.

For example, you could assign the following static IP address to your computer:

**Example Computer IP address: 192.168.2.50**

**Example Computer Subnet Mask: 255.255.255.0**

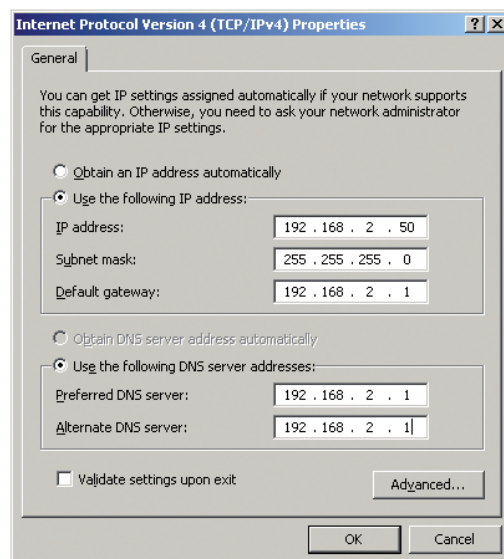

Then into your web browser, please enter directly the IP address or host name of the **LiveCore™ unit** into the address bar of your browser:

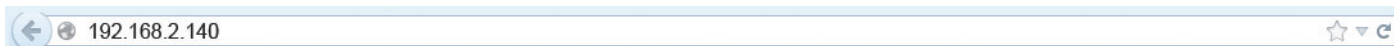

Once connected this screen will appear:



#### In case of difficulties:

- Verify that you are using the correct network cable and that it is free from defects. (Crossover or straight cable as required.)
- Check the IP address of your control computer. It must have a unique IP address on the same network as your **LiveCore™ unit**.
- You may need to temporarily disable any other networks on the computer, such as turning off the Wi-Fi connection
- Refresh your Web RCS
- Restart your browser

Once your computer has established connection, the **Web RCS** control panel will begin to load and to synchronize with the device. When the small “Sync” icon at the bottom right of the display turns green, the Web RCS software is ready to use.



Some computers use an energy saving mode that turns off the network adaptor during periods of inactivity. To avoid the inconvenience of reconnecting the software during use, please ensure your network adaptor remains active by disabling the energy saving mode.

## 6.3 Web RCS top Menu



### 6.3.1 Setup

The Setup page is where you will review and modify the device configuration, such as output resolutions, input settings, backup and restore options, and more

### 6.3.2 Edit

The Edit mode is the place where you will manage preset creation. You will make input selections, manage your inputs, adjust the layer attributes such as size, position, effect, etc... You can save all your screen configurations into presets, as well as review and recall them on each individual screen. The Edit screen can display and edit only one screen at a time.

### 6.3.3 Live

The Live mode is the section where you will operate your show. You can quickly recall presets or make input selections, as well as setup a sequence of presets that can run continuously with custom durations, or wait for user interaction. The Live screen will allow you to access and control presets on all screens simultaneously.

## 7. OPERATING A LIVECORE™ UNIT FROM THE WEB RCS

### 7.1 Functional mode

Unlike some other devices, **LiveCore™ unit** is not defined by an overall operating mode. Each output is configured individually. **LiveCore™ unit** can be used in Mixer mode, Soft Edge Blending mode, as well as a Hybrid mode.

### 7.2 Display configurations

#### 7.2.1 Single device configuration

**NOTE:** number of screens and layers can change depending on your device

#### Standard output

The outputs of a **LiveCore™ unit** can be defined in many ways (4 outputs unit). These outputs can be configured as:

- Four Program outputs
- Output #1 and output #2 in a Soft Edge/Hard Edge mode, then output #3 and output #4 in a Soft/Hard Edge
- Three Program and one Confidence output

Here are some configuration examples for a 4U unit:

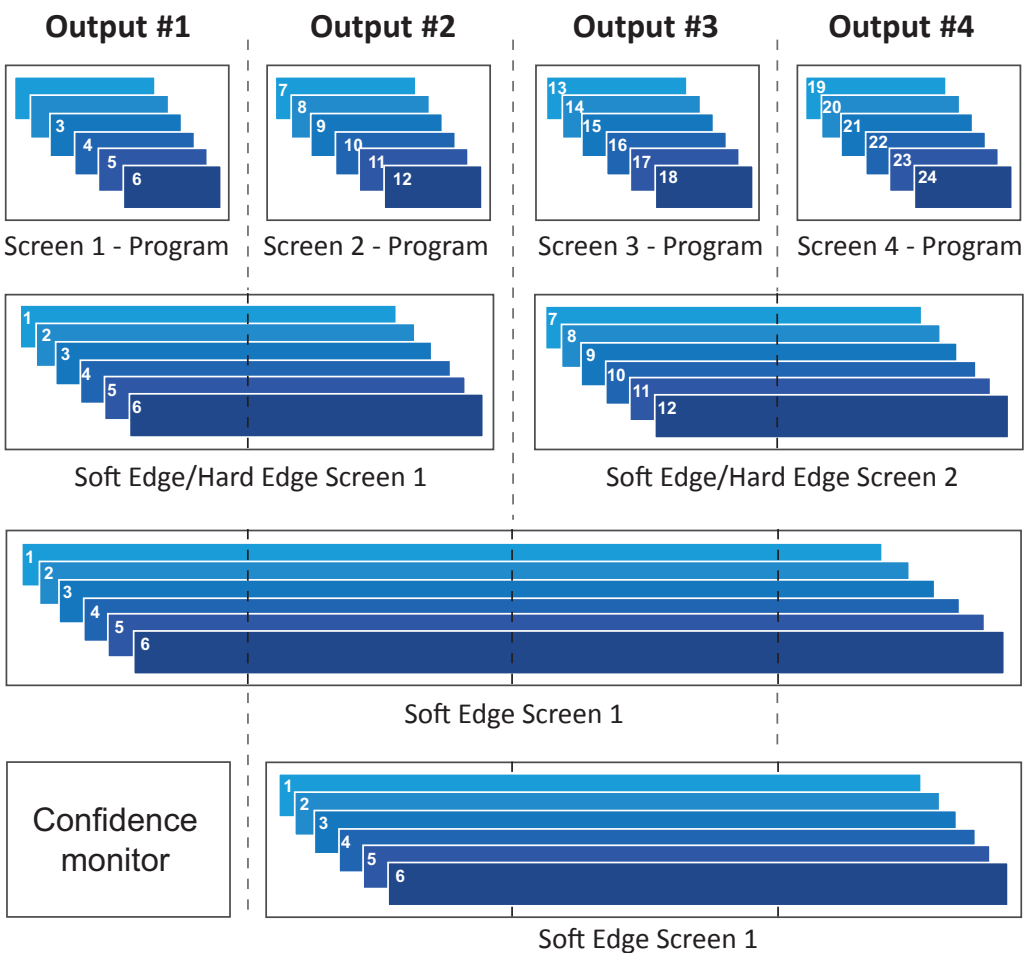

## Monitoring output

The monitoring output is a configurable multiviewer output that can display a user customizable selection of program, preview, source, and frame inputs as display resources. See the following examples:

### MULTI-SCREEN CONFIGURATION

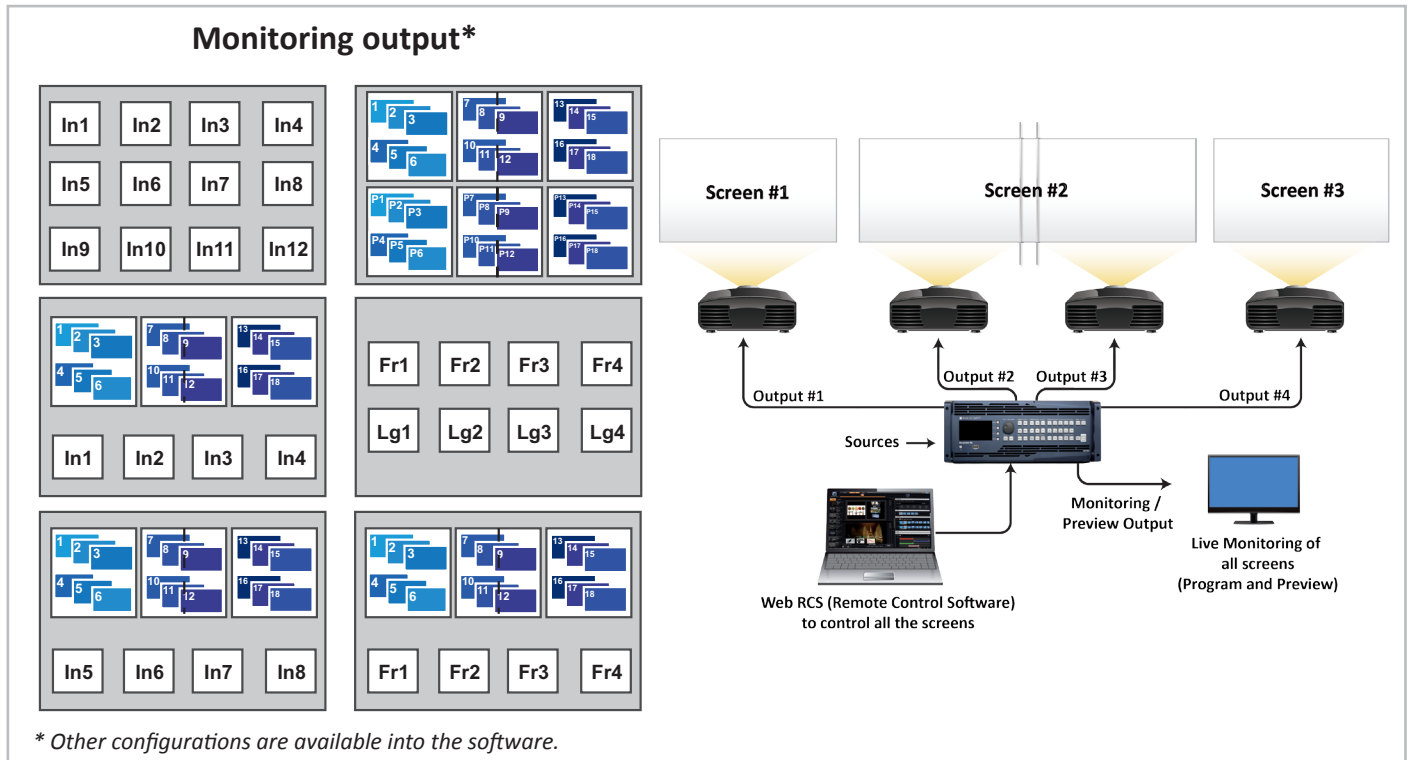

### SOFT EDGE CONFIGURATION WITH ONE OUTPUT USED AS CONFIDENCE MONITOR

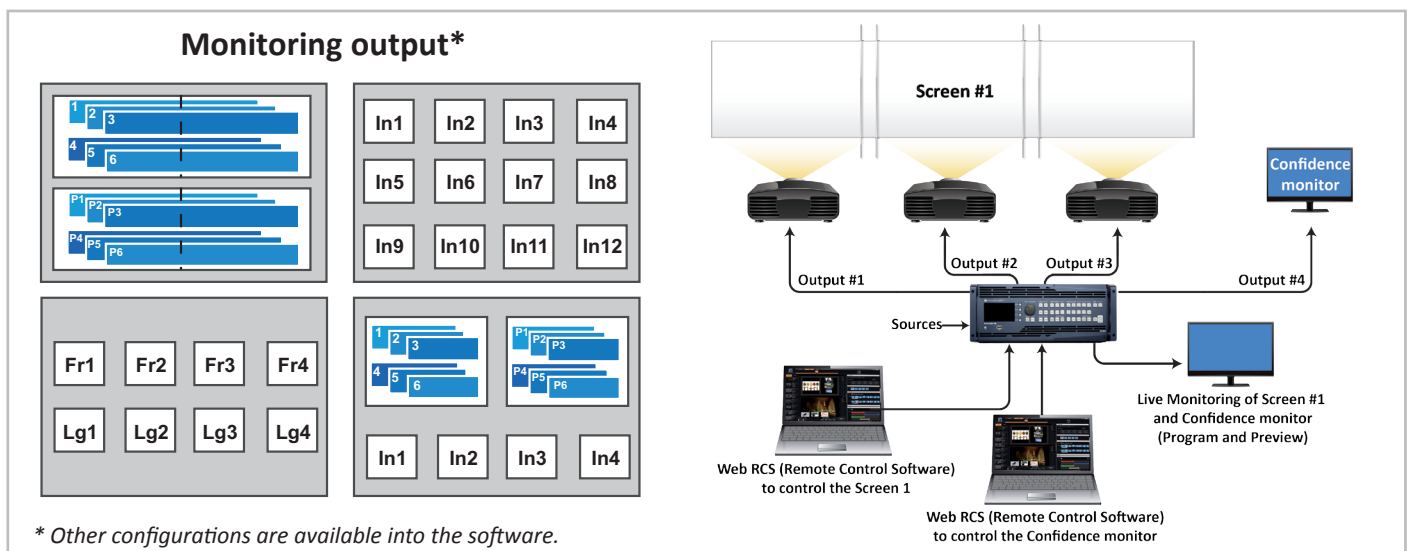

Several outputs can be declared as a Confidence Monitor

Please note that displaying a blending will need as much resources as the number of output in the blending. Dual-head inputs and dual-link signals need two resources to be displayed.

**NOTE:** those schematics are based on the **Ascender 48 - 4K - PL** architecture. For 4RU unit, 12 windows are available into the monitoring output. Only 8 monitoring output windows are available with 3U units.

## 7.3 Setup



Note that all the screenshot are made with an **Ascender 48 - 4K - PL**. Some features including number of layers, number of outputs, and number of inputs can change depending on the **LiveCore™** model.

Go to the Setup section to start setting up your unit. The **Preconfig Setup Assistant** will walk through the steps of setting up the basic device configuration.

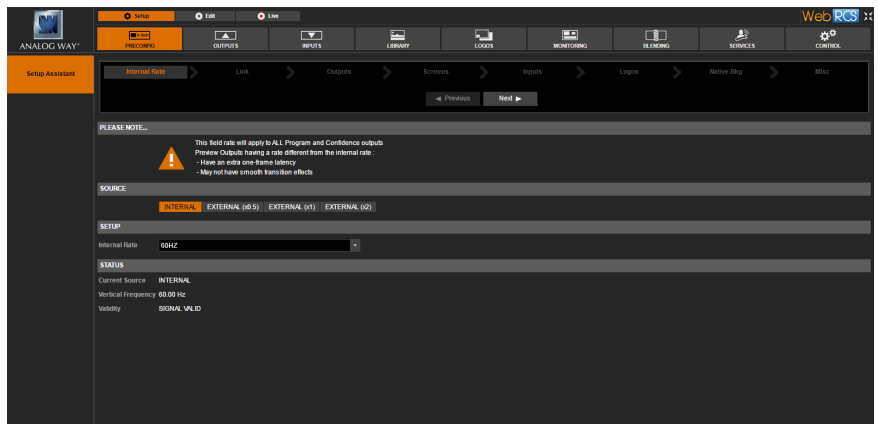

### 7.3.1 Internal rate

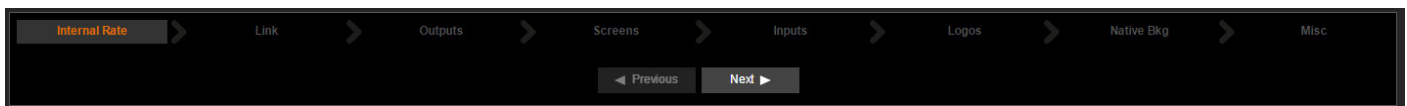

The Internal Rate section sets the overall internal operating frame rate of the unit, which defines the frame rate of all program outputs. This rate can be defined:

- Internal Rate (Free Run): you can define the internal rate as 25Hz, 50 Hz, 60Hz ... [**INTERNAL**]
- By choosing to follow one of the inputs or the framelock connector: select external and define which from plug the reference rate will be copied [**EXTERNAL**]

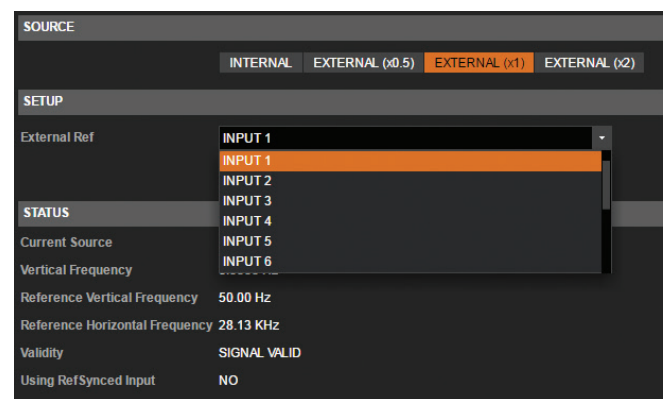
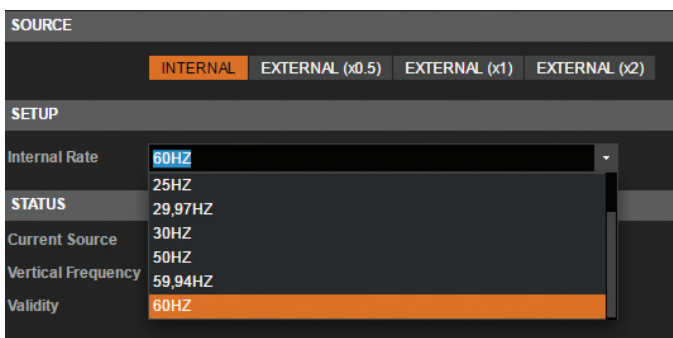

- If the Framelock plug is chosen as a reference, you must set up the type of analog sync signal expected on this connector.

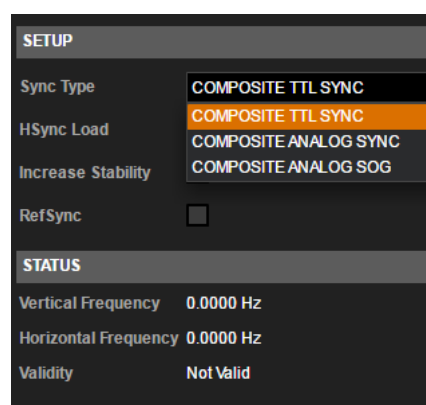
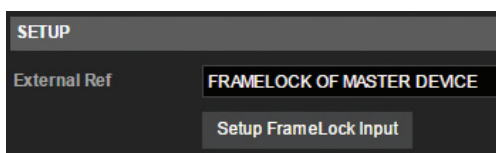

Once the source is defined, a summary of your rate settings is displayed under the tab **STATUS**.

**WARNING:** Configuring the rate to follow a framelock input will lock the output frame rate to match the selected source. This is useful to eliminate the “strobing effect” which may be visible as an artifact of the framelocking process. However, be sure that your framelock reference input is a reliable source, as any disruptions in the reference signal may cause visible glitches on your output, even if the selected framelock reference input is not currently being displayed.

### 7.3.2 Link section

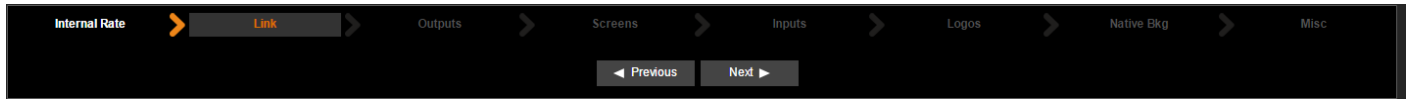

The **Link** section allows you to link 2 devices using the Additive Modularity feature. This feature is available for all 4U **LiveCore™** units, which can run as **Single Device** (standalone) or as a pair (together with another device) by linking them.

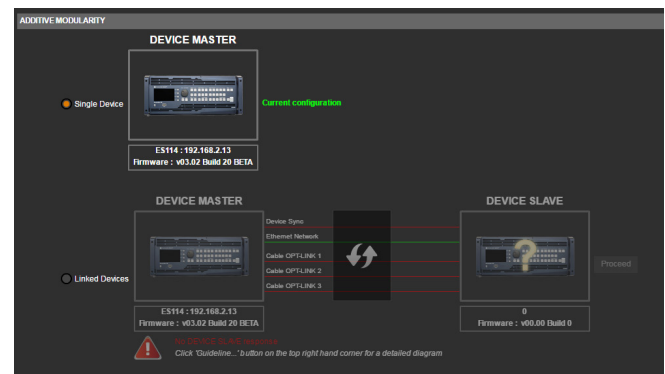
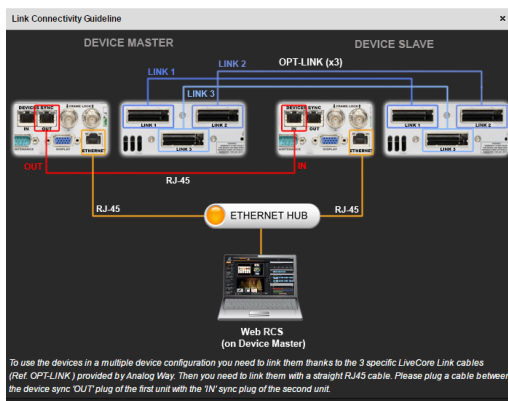

You can use the **Guideline** button at the upper right corner of the Link page to display a diagram of how to connect the 2 devices. See also chapter: **10. Assembling and devices coupling** for more information.

### 7.3.3 Outputs section

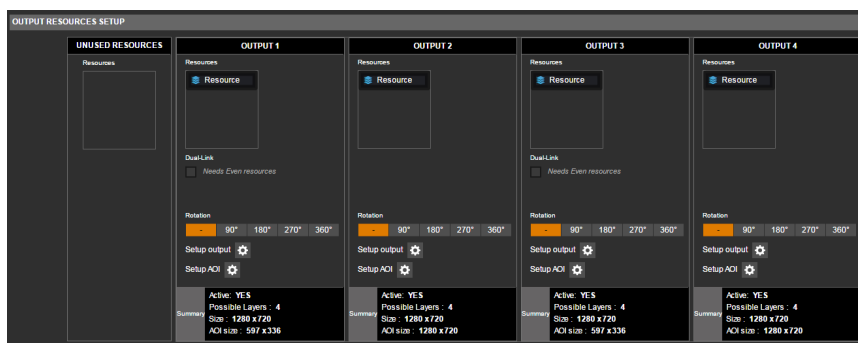
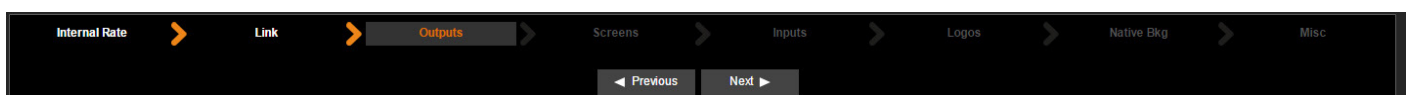

The Outputs section allows you to define your Dual-Link / 4K outputs, and allocate layer resources from one output to another.

To activate a Dual-Link output (i.e. 2560x1600 resolutions), drag resources from one (preferreably adjacent) output to the required Dual-Link output, and then check the **Dual-Link** option box for that output.



To activate an output for 4K resolutions via HDMI 1.4 (on units with the 4K hardware option), drag the adjacent resources to outputs #2 or #4 and then check the **Dual-Link/4K** option box. For the **4K/420** option, drag 4 output resources to output #2.

Resources assigned to an output can be applied to another one in order to use the output's layers on another output. Resources can only be assigned in blocks with a fix number of layers. For example, an **Ascender 48 - 4K - PL** normally has 6 layers on each output. You could move the resources from output #2 to output #1 and allow output #1 to display 12 layers.

### 360° rotation:

To rotate the output, select a rotation (90°, 180°, 270° or 360°). Note that selecting a rotation adds a latency to the output. The 360° rotation can thus be very useful to ensure the same latency across rotated and non-rotated outputs (required in sync mode).

### Output & AOI setup:

To quickly set up the output, select the **Setup output** button (see the [7.3.9 Output management chapter](#) for more information on output setup parameters).

To define the active area of your display in the output format (specially useful when using **LED wall** configurations), select the **Setup AOI** button. Specifying the size and position of the **AOI (Area Of Interest)** will allow you to remove unseen or useless display areas and operate exclusively on the actually displayed output area.

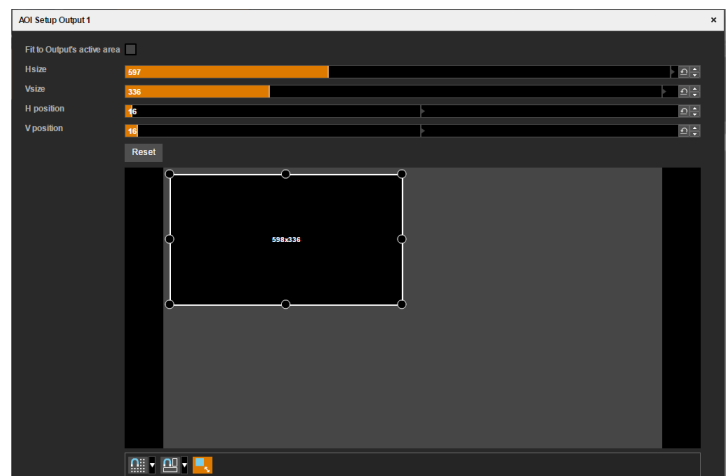

A status panel at the bottom of each output indicates if the output is active and how many layers are available, based on the number of output resources assigned to the output. The size of the output and its AOI is also displayed.



## 7.3.4 Screens

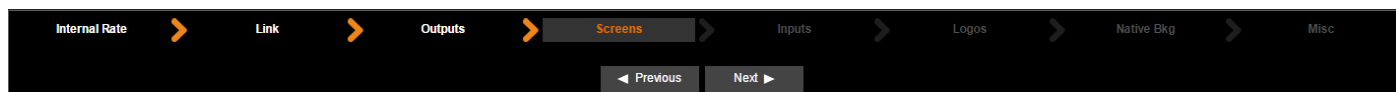

The screens page allows you to map a particular output to a particular screen destination or part of a screen.

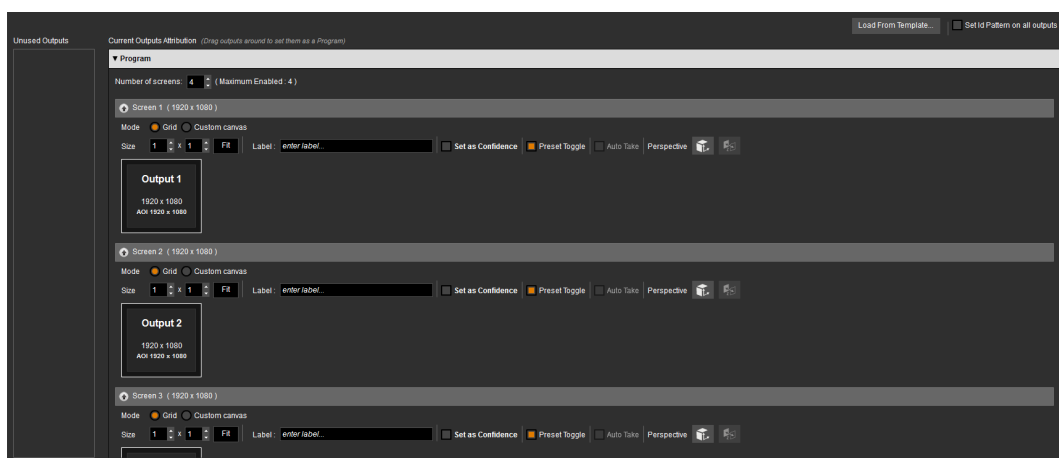

You can map any output to any screen. To map an output to a particular screen, simply drag and drop the output to the desired screen destination. Note that by default Output #1 = Screen #1, Output #2 = Screen #2 etc.

You can also combine several outputs into a single screen, for example to create a Dual output blend. On a 4U **LiveCore™** unit (4 available outputs) you can create up to 2 Dual output blends for example.

To set up a Dual output blend, select a screen and check the **Grid Mode**. Increase the screen size to 2x1 and then drag and drop each output to one screen area (grid dimension). If using the screen as Soft Edge blend, see **7.3.14 Blending management** for Soft Edge Blending overlapping adjustments.

To freely combine outputs into a specific screen pixel area (for example in Hard-Edge / LED wall configurations, or when combining different output formats), select a screen and check the **Custom Canvas Mode**. Specify the screen size (in pixels) and then drag and drop the required output(s) to the screen's **Layout: Output List**. Finally, click on the layout setup button to position the output(s) in the screen.

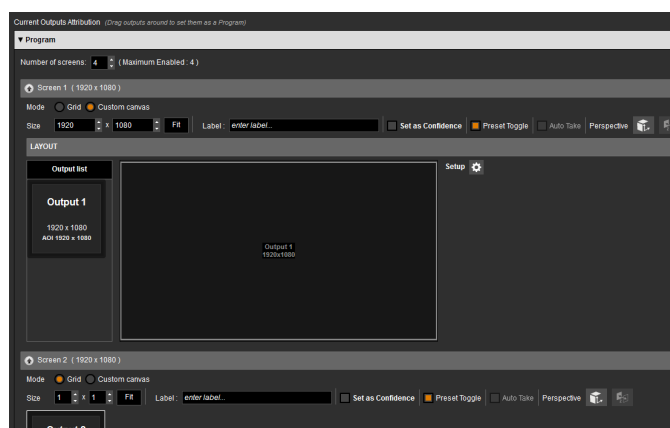

You can also configure your Program screens as confidence monitors by enabling the associated **Set As Confidence** option. Later during **Edit** and **Live**, you will be able to create layouts and layout memories of your confidence screens. *Please refer to 7.4.9 Confidence management for more information.*

The **Preset Toggle** option enables a copy of the program on the preview at each Take, resulting in an effective “swap” or “flip-flop” of program and preview.

If enabled, the **Auto Take** option triggers a Take as soon as another source is applied to a layer.

The **Enable Rotation** status tells you whether the screen has rotation processing enabled or not. Rotation processing is automatically enabled when one of the screen's outputs uses rotations. This way the same latency is ensured on all screen outputs, including non-rotated outputs. To ensure the same latency across

rotated and non-rotated screens (required in sync mode), enable rotation processing on each non-rotated screen via the 360° rotation of one of its outputs (see **7.3.3 Outputs section** for more information).

Please note that on the **Ascender 48 - 4K - PL** (Ref. ASC4806-4K-PL) and the **Ascender 32 - 4K - PL** (Ref. ASC3204-4K-PL), the Perspective Layers option must be enabled here. Please refer to the **chapter 7.6 How to operate Perspective Layers on the Ascender 48 - 4K - PL & the Ascender 32 - 4K - PL** for details.

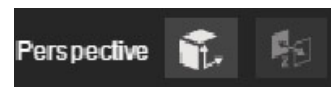

**Examples of grid screen configurations:**

**2 screens:  
3 Program outputs and 1 Confidence output**

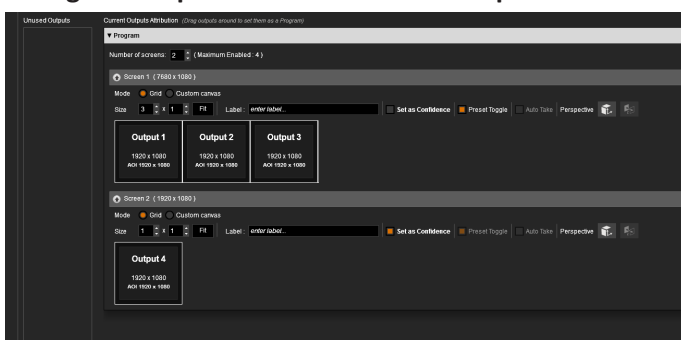

**2 screens:  
Program outputs 1 & 2 and Program outputs 3 & 4**

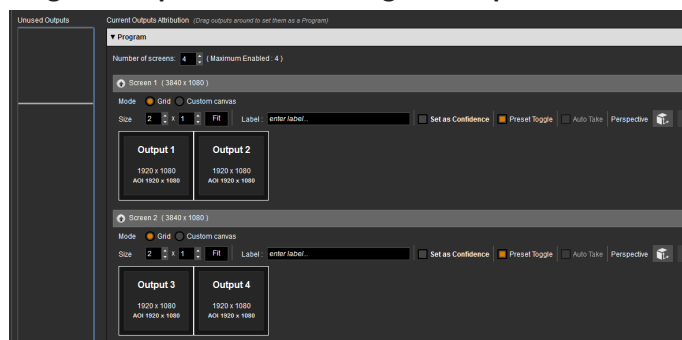

**4 screens:  
4 Program outputs**

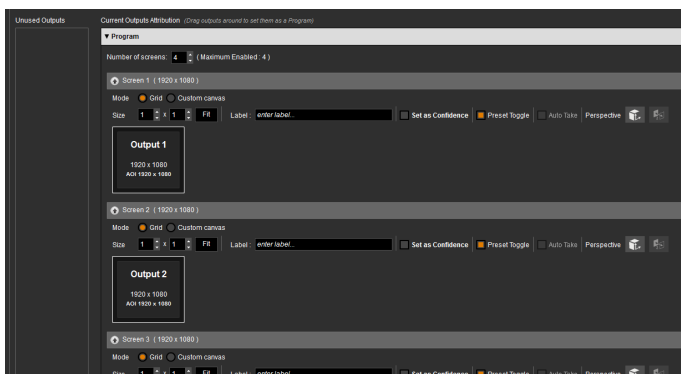

**1 screen: 4 outputs as Hard Edge**

You can build Hard edge and Soft edge screen configurations, both horizontally and/or vertically:

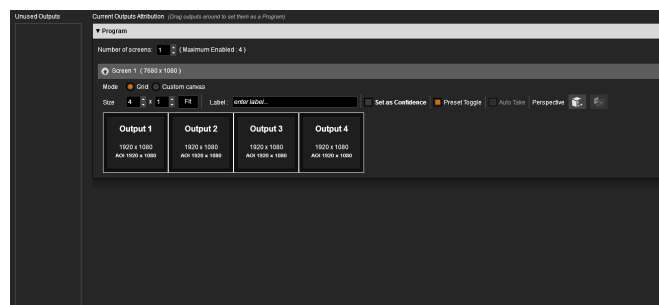
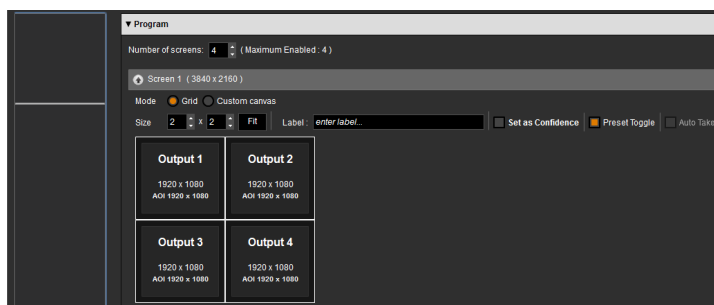

Please note that when you use different output resolutions in the same screen, the total screen width will be the sum of the largest width in each column and the total screen height will be the sum of the tallest height in each row.

## Examples of custom canvas screen configurations:

### 1 screen: 2 outputs with different formats as Hard Edge

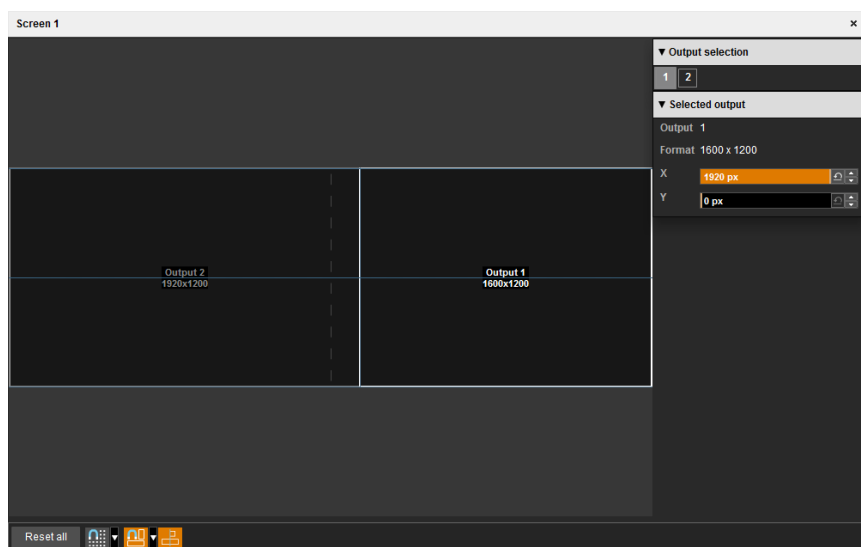

### 1 screen: 4 outputs with different formats and rotations

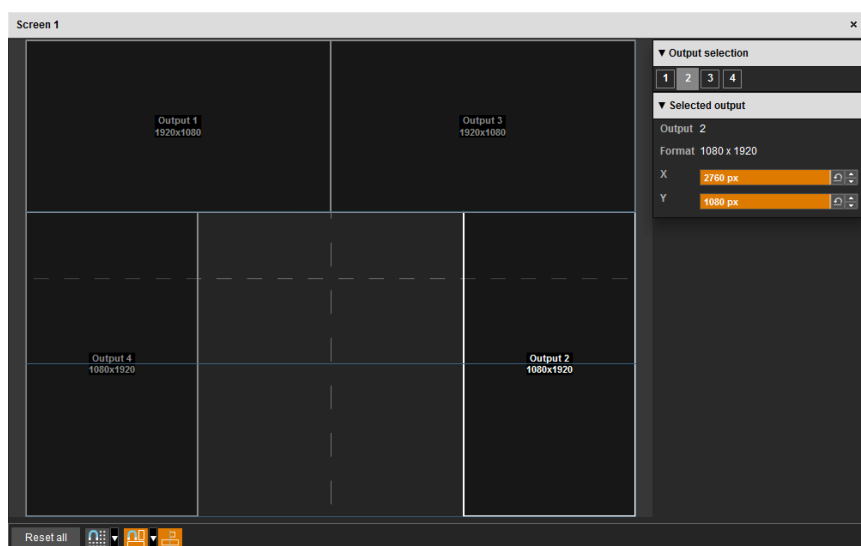

### 1 screen: 2 outputs with different formats on a commonly displayed area

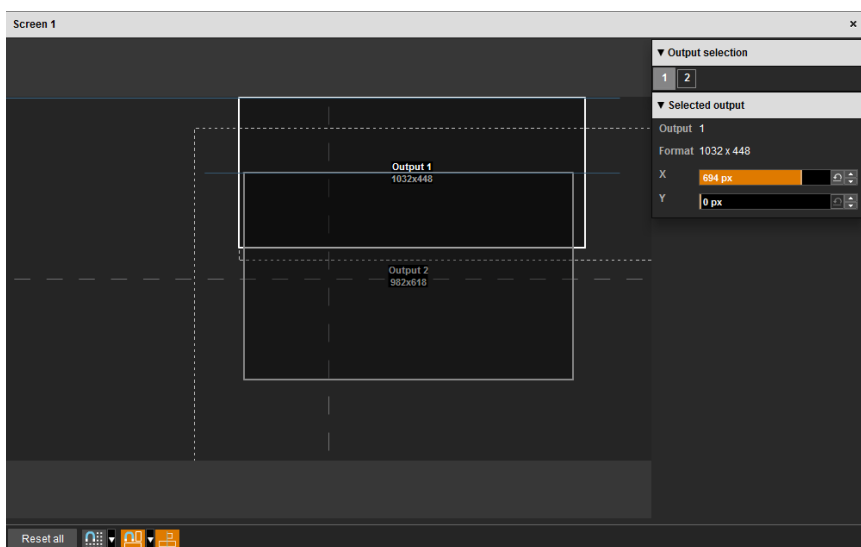

- **LOAD FROM TEMPLATES:** The **Load From Template** button (located in the upper right side corner) will help you build your grid screen configurations based on predefined templates. Available templates include: 4 independent screens, blends of 2 projectors, blends of 4 projectors, setup for 4K via quad output, and more. Simply click on this button to access the template list, and then select a template to automatically configure the screen layout and assign the required resources to the screens.

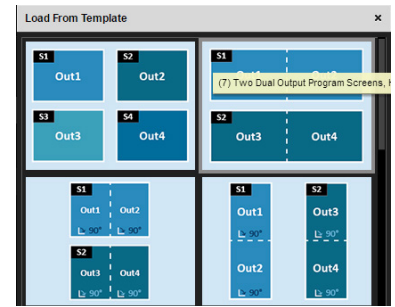

- **SET ID PATTERN:** click on this feature to automatically display the output ID test pattern, which indicates the output number visually as an output signal.

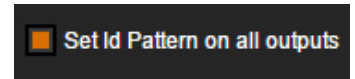

### 7.3.5 Inputs section

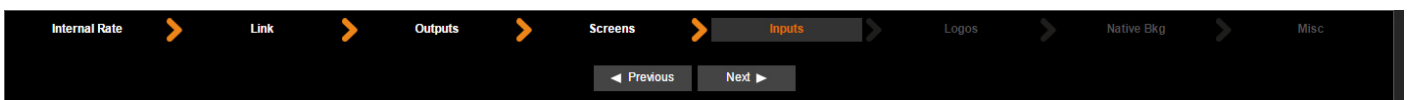

In this section, you can specify which inputs can be used as native background. The native background is a non-scaled layer displayed behind all of the scaled layers: A, B, C, D, etc. When an input is set as a possible native background, you lose the anamorphic aspect settings of the input but you can still configure other input settings like colorimetry, cropping etc. (see *Aspect ratio in chapter: 7.3.10 Input management*).

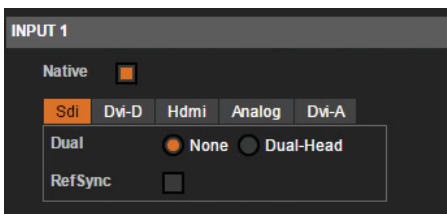

In the Inputs section, you can also define which inputs will be Dual-Head, meaning inputs that are paired to display adjacent (but not overlapping) content. If you are using overlapped content, you should skip applying the dual-head setting and proceed to the Native Background configuration. Select the plug that you need to adjust and apply the Dual-Head or Dual-Link setting as necessary. (See *chapter: 7.3.10 Input management*.)

The Ref Sync feature is also available here for each input plug. If you use framelocked inputs, you need to check the ref sync box for every framelocked input that shares the frame lock reference. This will reduce the frame delay by disabling the Frame Rate Conversion, using the frame lock as the default rate. Please note however that all the inputs that are synchronized with this reference will still have a minimal latency of 1 frame at the output of the LiveCore™ unit.

Please note that for 4K devices, you will have the possibility to set the inputs HDMI #2, #6 and #10 as 4K inputs. Please see details in *chapter 7.3.10 Input management*.

### 7.3.6 Logos

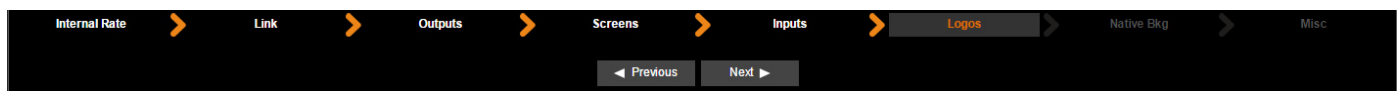

In this section, you can specify which Frames can be used as native background. The native background is a non-scaled layer displayed behind all of the scaled layers: A, B, C, D, etc. When a Frame is set as a possible native background, you lose the anamorphic aspect settings of the Frame.

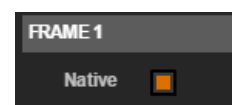

## 7.3.7 Native background section

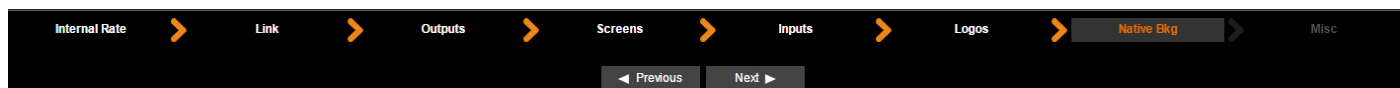

The native background is an additional layer which is under all the other layers. An input source, a frame or a color can be assigned to the native background.

The specification of the native background is that an input source or a Frame loaded into that layer will not be scaled (1:1). The input is displayed with its native resolution.

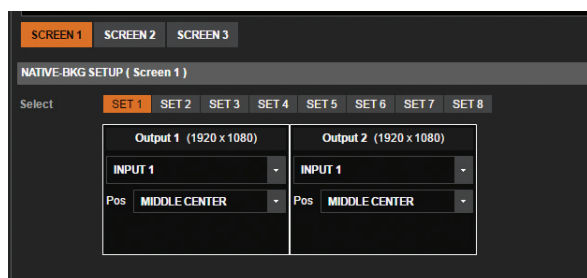
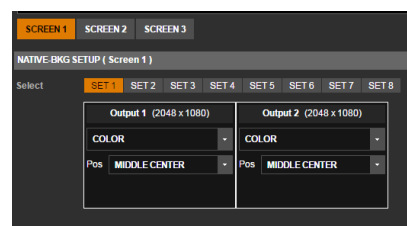

The most common and useful way to use the native background feature is to use an input(s) of the same resolution as each output(s).

To use one of the input sources as native background for one of the outputs, Go to **Setup > Preconfig > Inputs** and enable **NATIVE** for the inputs you want to be able to use as native.

Then, under **Setup > Preconfig > Native Bkg**, assign the input

to a native background set.

Be careful about enabling all inputs as native background input. When enabled, the input loses some aspect ratio process: the **INPUT > ASPECT IN** is forced to None and anamorphic values are not available anymore.

Similarly, if you want to use a Frame as native background:

Under **Setup > Preconfig > Logos**, enable **NATIVE** for the Frames that you want to be able to use as native.

Then, under **Setup > Preconfig > Native Bkg**, assign the Frame to a native background set.

You can assign an Input source, a Frame or a color to each set.

Please note that only Input sources and Frames for which **NATIVE** has been enabled will be available for selection in the set's **NATIVE-BKG SETUP** page.

See [7.4.4 Layer selection and native background](#) for more information on how to use native backgrounds with your screens.

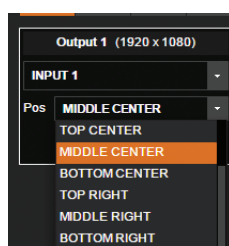
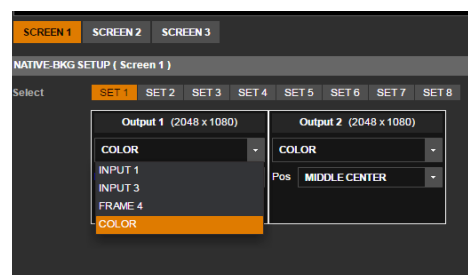

You can also configure the position of each native background set within the screen:

The position is important in the case you choose a Frame/input which has a smaller resolution than the output resolution, your native background will be placed according to this chosen position.

Dual resolution inputs can be displayed on a 2x1 screen on the native background, choosing two times the same input.

Select for each set the desired native background source. Load each set clicking on the set number to check the settings for each native background are configured properly. Don't forget that you can come back to this section at any time during your show to define new native input or new set. There is no limitation about changing a background set showing on the program.

## 7.3.8 The Miscellaneous section

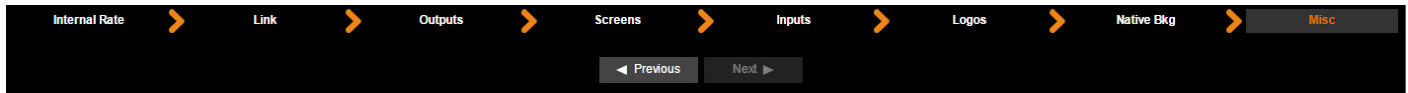

- **DYNAMIC FIT:** Enable or disable the automatic layer size adaptation depending the source aspect. If disabled with a larger layer, space around the source is filled in black.
- **PREVIEW ASPECT:** Change between 3 ways of displaying the Preview during transition.
- **PIP COLOR:** Color of PIPs when the source is set to Color
- **KEYING COLOR:** Replacement color when input keying DSK is enabled.
- **PRESET AUTO FADE:** This is the duration of the auto fade In/fade Out. (See *faders in chapter: 7.4.4 Layer selection and native background*)
- **PRESET BORDERS:** This setting allows you to change the aspect of borders (rounded corner radius). (See *borders in chapter: 7.4.2 Layer properties*).
- **SCREEN MIRRORING:** Enable or disable access to the mirror effect. (See *mirror in chapter: 7.4.4 Layer selection and native background*) (only useful when using Hybrid mode).

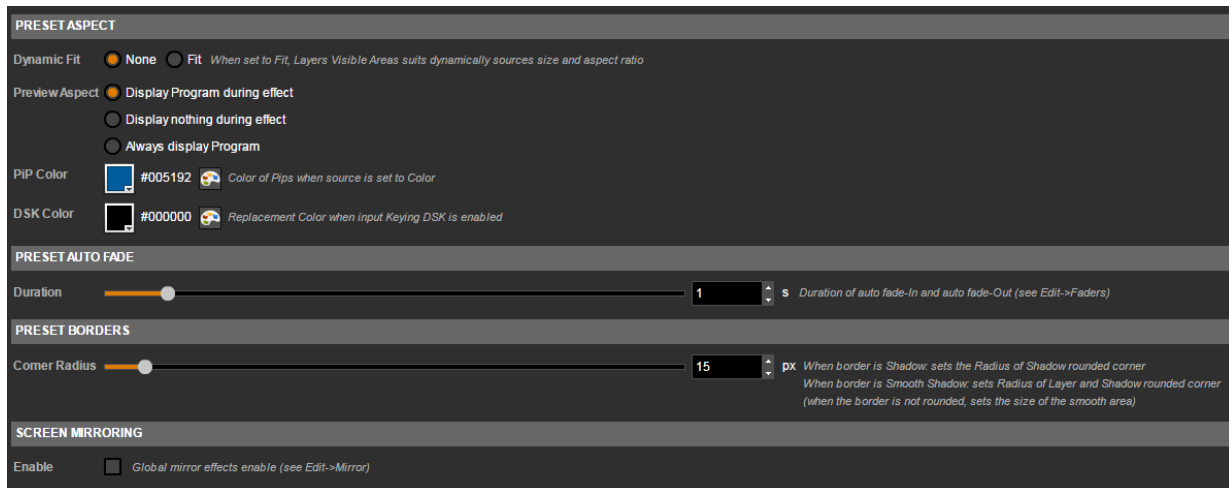

## 7.3.9 Output management

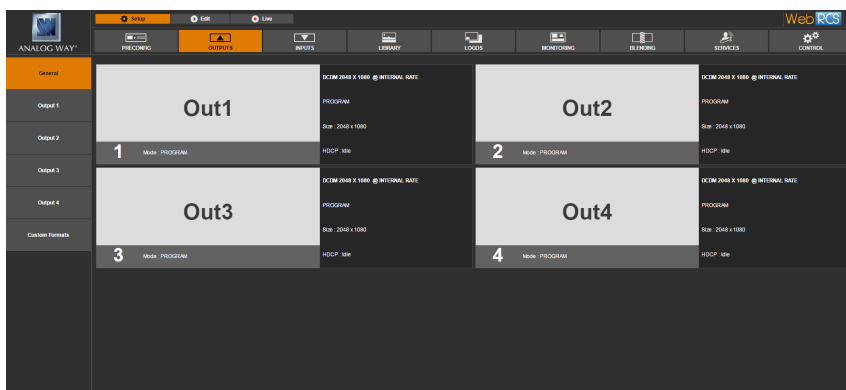

In the **SETUP > OUTPUTS** section, you can manage your output resolutions, formats, sync types, test patterns, ...

Under the **General** tab, you can see a summary of all your outputs: number of outputs, resolutions, rate and HDCP status. To access the settings of a particular output, hover over the output and click on the **Setup** button or select the output directly from the left side toolbar (tabs **Output 1**, **Output 2**, ...).

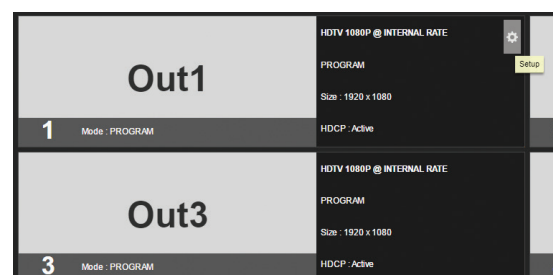

Once the output setup page is loaded, you can edit the following output settings:

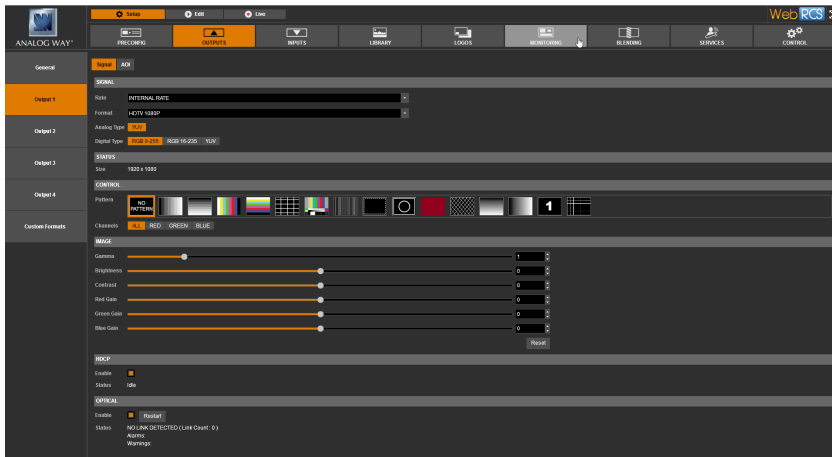

- **RATE:** Choose the rate for the output (4 outputs units only). Note: the **Internal Rate** mode allows you to synchronize the output to the system clock, and it is required on all soft-edge/hard-edge outputs. The latency of outputs not using the internal rate mode will be increased by one frame due to the frame rate conversion. Use the **Apply to all Screen# outputs** button to apply the same rate to all the outputs using the same screen.
- **FORMAT:** Choose the output resolution format. Note: you can use the **Apply to all Screen# outputs** button to apply the same format to all the outputs using the same screen.
- **TIMING:** Choose the signal timing standards.
- **TYPE:** You can choose the type of output synchronization on the analog plug, for example RGSB for sync on green, or RGBHV for separate H and V sync wires. For digital plug, the color type (Full RGB, RGB 16-235, YUV).
- **MODE:** Only for 4K signal, choose the mode: DVI, HDMI or AUTO
- **STATUS:** The status menu will show you the current output status.
- **PATTERN:** A selection of patterns is available to test your output. These patterns will override any input selection that you might have. Most patterns offer adjustment to isolate a particular color for easier troubleshooting and calibration.

You can choose from:

- **No Pattern** – turns the pattern off.
- **Vertical or horizontal Grey Bars** – displays grey bars
- **Vertical or horizontal Color Bars** – displays color bars
- **Grid** – displays an 8x8 box grid pattern
- **SMPTE bars** – displays the SMPTE color bar pattern
- **Vertical Burst** – displays alternating black and white 1 pixel wide columns Centering – Displays a 1 pixel wide dotted line at the last pixel of the output
- **Centering** – displays dotted line all around the screen to be sure to not lose pixels
- **Circle** – displays a circle, no matter what the resolution of the output is. This is useful for checking aspect ratio and geometry through your system.
- **Solid color** – displays a choice of color that fills the screen.
- **Diagonal crosshatch** – displays a diagonal line pattern which can be adjusted in size.
- **Vertical or horizontal gradient** – displays a 0 to 100% gradient pattern
- **Output ID** – displays the number of the output as a numeral on the screen
- **Moving crosshair** – displays a crosshair which moves around the screen.

Please note that depending on the rate, only some formats are available.

- **FLICKER:** Choose the value of the flicker filter to remove the flicker effect on your interlaced output screen.
- **GAMMA:** Increase or decrease the gamma of your output.
- **BRIGHTNESS:** Adjust the brightness level.
- **CONTRAST:** Adjust the contrast level.
- **GAIN (R/G/B):** Adjust the component balance (red, green and blue).
- **HDCP:** Enable/disable and see the HDCP status\*
- **OPTICAL PLUG:** Enable/disable and see the optical status

Please note that depending on the output format currently selected, all settings might not appear.

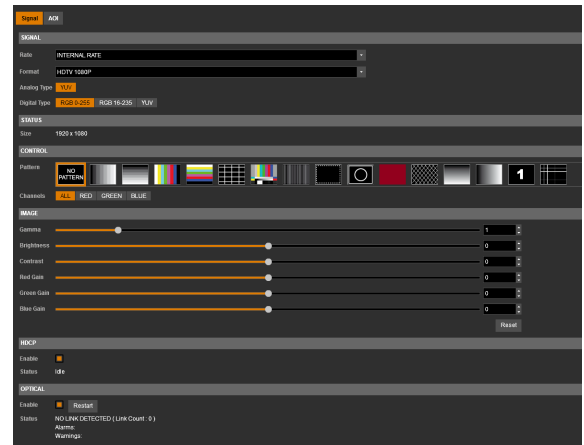

\*The aim of disable the HDCP is to reduce possible problems when the chain isn't fully HDCP compliant. By disable the output HDCP, HDCP inputs will not be displayed anymore.

To the right of the **Signal** tab, the **AOI** tab allows you to define the active area of your display in the output format. Specifying the size and position of the **AOI (Area Of Interest)** will allow you to remove unseen or useless display areas and operate exclusively on the actually displayed output area.

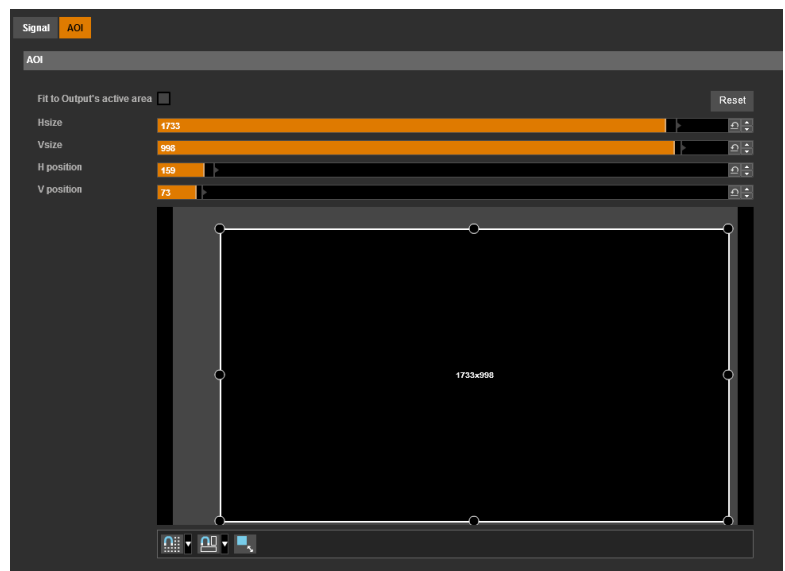

## CUSTOM FORMATS

Under the **Custom Formats** tab, you can edit your own custom format memories.

Custom format memories allow you to create custom output computer formats, very useful for LED wall applications and non-standard display applications for example.

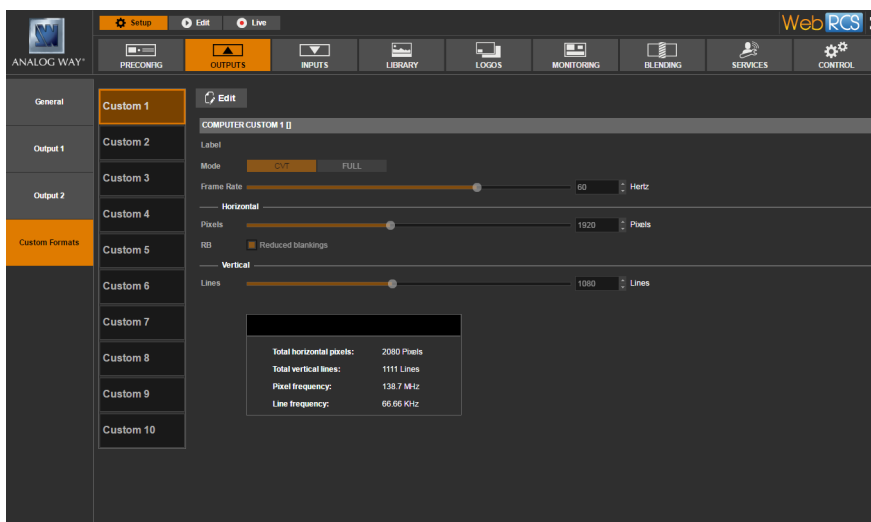

You can use custom formats to create wide single link formats (pixel frequency <165MHz). For example 2400x700@60Hz (i.e. Dual link outputs with single link formats).

To create a custom format, first select a custom format memory slot from the left side toolbar (tabs **Custom 1**, **Custom 2**, ..., **Custom 10**).

Next, click on **Edit** and select **CVT** or **FULL mode** to edit the custom format parameters:



- In **CVT mode**, you only need to set the width, height and rate of the format and indicate if the format has reduced blanking intervals. The system computes the remaining format parameters according to the CVT 1.1 standard.

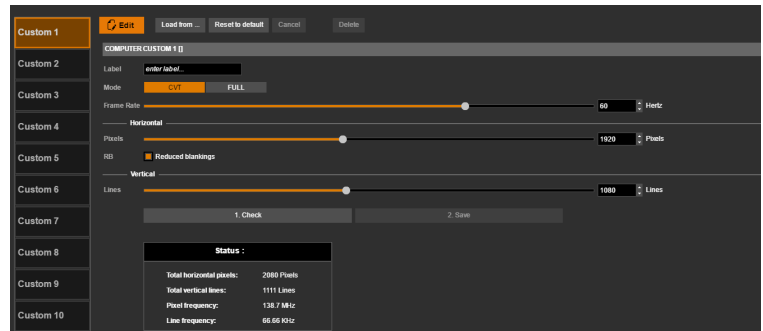

- In **FULL mode**, you can set all the parameters of the format (H&V front porch, H&V sync, H&V back porch, width, height, sync polarity, ...).

**TIP:** For each edit mode, you can edit the required parameters or use the pre-filled default values. See also **Load from** below.

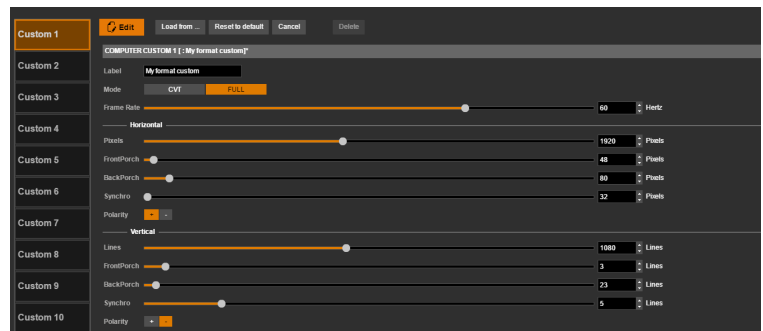

Once your custom format is ready, click on **Check** to check that the new format settings fit the unit capabilities (pixel frequency, line frequency, ...). If there is a warning, check the warning message:

- **Red warning:** Format not valid.
- **Yellow warning:** Format valid with certain limitations (for example, too many lines if Rotation and Dual link are enabled on the output).

If the new settings are valid (yellow or no warning), you can click on the **Save** button to save the new format settings. Your saved custom formats will appear in the list of available formats when setting up the output format, provided that the custom format rate equals the internal rate (*see also 7.3.1 Internal Rate and 7.3.3 Output settings*).

In **Edit** mode, the following options are also available:

- **LABEL:** provide a name for your custom format.
- **LOAD FROM:** use a saved custom format to pre-fill the custom format values.
- **RESET TO DEFAULT:** reset all the custom format values to their default (Edit mode) value.
- **CANCEL:** cancel the current changes and reset the custom format values to their last saved value.
- **DELETE:** delete the custom format (the custom format will no longer appear in the list of available output formats and the custom format memory slot will be emptied and reset to default values).

### 7.3.10 Input management

Once your outputs are configured, you have now to configure the inputs connected to your **LiveCore™ unit**. Under the Inputs section, you can view your inputs **by active plugs** or **by all plugs** (active and inactive).

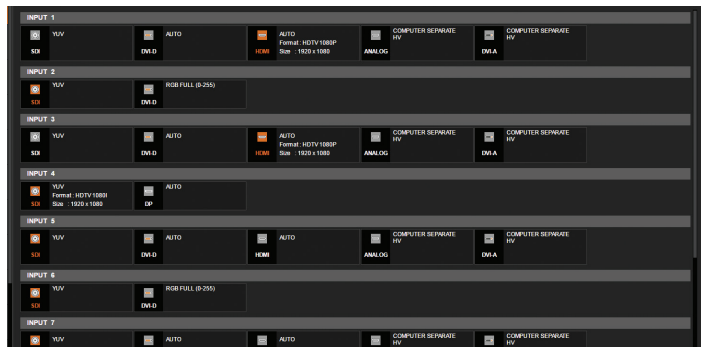
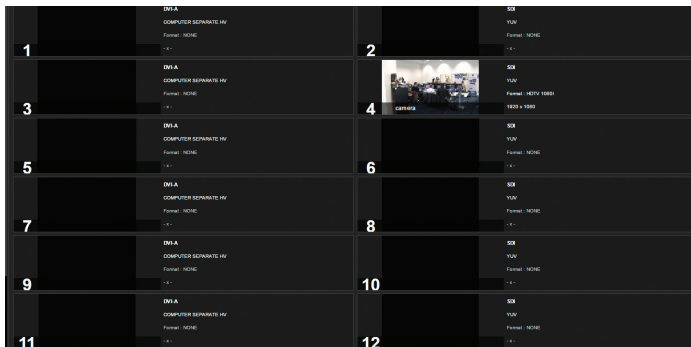

All plugs view for 4K devices

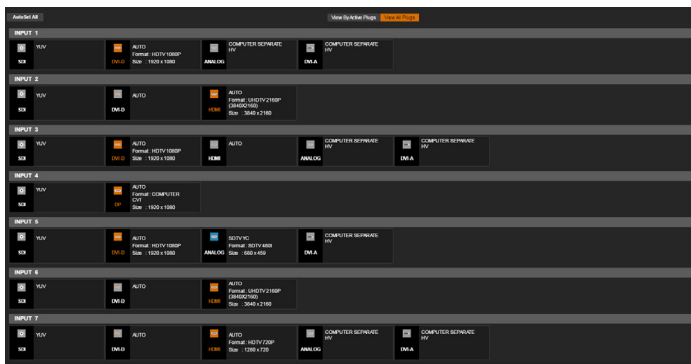

In both cases, an **AUTOSET ALL** can be launched to set up automatically your inputs.

Once the **AUTOSET ALL** is done, you can check each of the inputs and see if they are detected properly using the input **STATUS**. The input **STATUS** is defined by a **FORMAT** and a **SIZE**. If that information is not available, your input has not been detected or set up properly.

In this case, you can manually enter into each input settings by using the left menu:

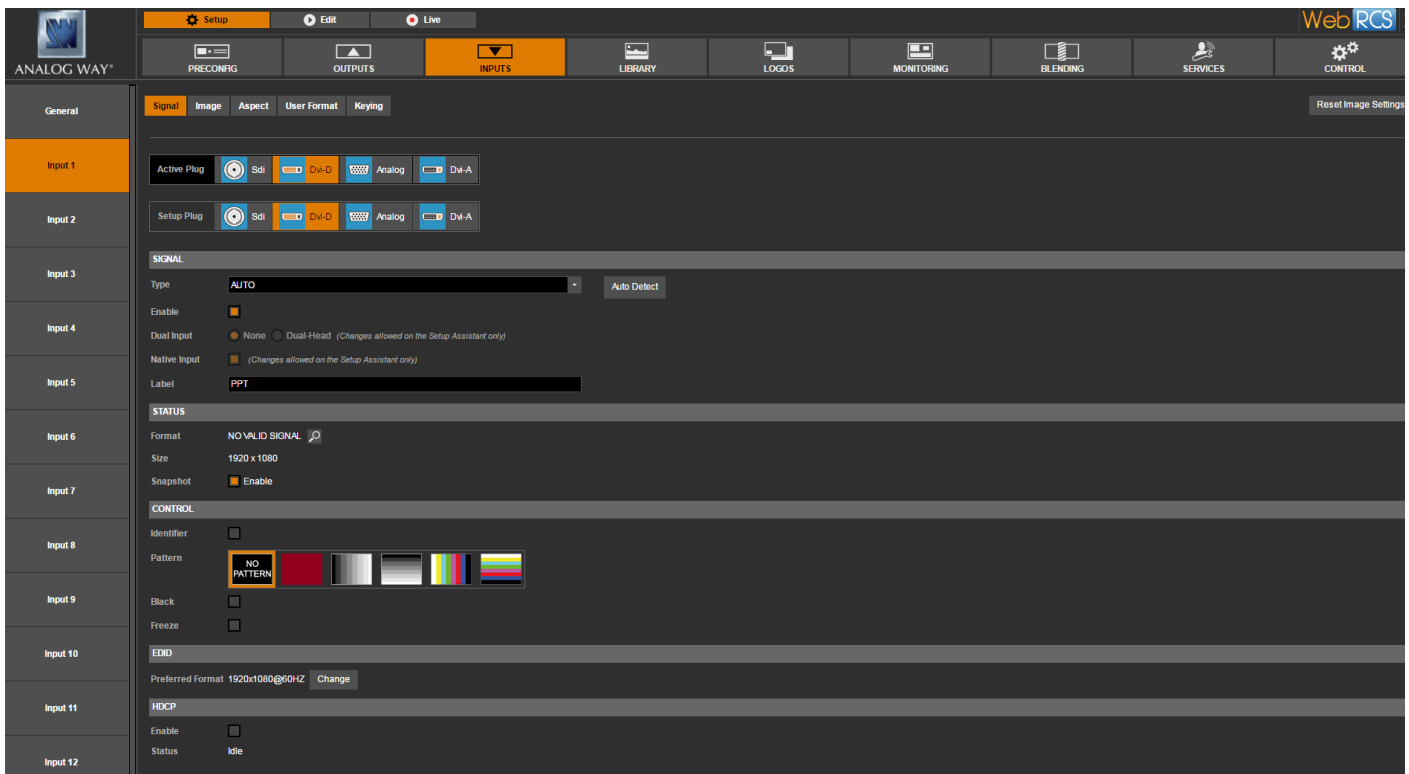

### Under the SIGNAL tab, you will find:

- **ACTIVE PLUG:** Select the plug used by the unit at the moment. Only this plug can be displayed on your output.
- **SETUP PLUG:** Select the plug you want to set up, all changes will be applied to this plug, even if this plug is active or not.
- **SIGNAL TYPE:** Define the type of your signal, video SD/HD YUV/RGB or Computer HV/SOG etc...
- **SD STANDARD:** Only available for SD signal, set up to auto (NTSC, PAL, SECAM,...) or manual recognition of SD signal type.
- **SD STABILITY:** Enable or not to define that the signal isn't stable (VCR type, enlargement of the tolerance) for stability of SD signal (use stable by default).
- **SD COMB FILTER:** Enable or not the comb filter for SD signal. It avoids the interlaced lines problem
- **ENABLE:** Enable/disable the input. A disabled input doesn't appear anymore on the EDIT/LIVE pages and can't be assigned to a layer.
- **DUAL INPUT:** Status of the input if configured in Dual-Link mode.
- **LABEL:** Rename your input plug according to your source.

### Dual-Link (change only into the Setup Assistant > INPUTS)

The Dual-Link DVI and DisplayPort inputs can be supported on the **LiveCore™ unit**.

You can choose to use the Dual-Link input into the Input section under the Setup mode. Select the input #2, #4, #6, #8, #10 or #12 and select **DUAL-LINK** mode.

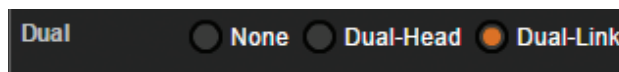

Be sure to select the DVI or DisplayPort input plug to see the Dual-Link option.

Inputs #2, #6 & #10: DVI

Inputs #4, #8 & #12: DisplayPort

When the Dual-Link feature is active, it automatically disables the input #1 (linked to input #2), input #5 (linked to input #6) and input #9 (linked to input #10) as the unit needs these inputs to handle the Dual-Link input (in case of DVI). The same thing will happen with inputs #4, #8 & #12 on DisplayPorts. Enabling the Dual-Link on these inputs disables the inputs #3,#7 or #11.

### Dual-Head (change only into the Setup Assistant > INPUTS)

The Dual-Head feature is useful when you want to support a high resolution image using more than one cable as side by side images. In order to use this feature, run your Dual-Head PC graphics board delivering your high resolution image split in 2 cables and plug it into 2 plugs of the **LiveCore™ unit**.

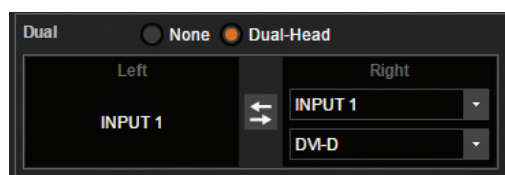

Under the Input setup menu, you can check the feature **DUAL-HEAD** of your inputs. You just need to indicate which second plug is linked to the actual input. In this example, the input #2 is linked in Dual-Head with the input #1 .

#### 4K (change only into the setup assistant > INPUTS, only for 4K devices)

The HDMI 4K inputs can be supported on the **LiveCore™** unit for devices with the optional 4K. In order to use a 4K resolution, select the input #2, #6 and #10 and select 4K.

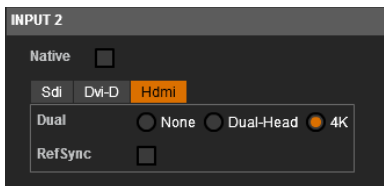

When the 4K feature is activated for an input, it automatically disables the adjacent input: input #1 linked to input #2, input #5 linked to input #6 and input #9 linked to input #10. The unit needs those input to handle the 4K input.

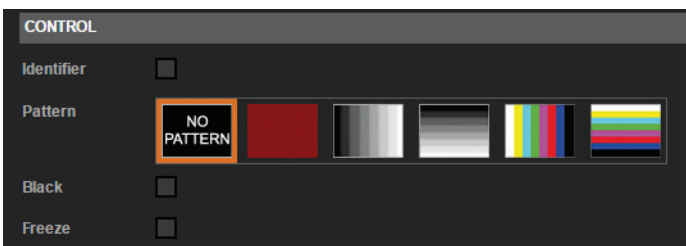

Under the **CONTROL** section, you have:

- **IDENTIFIER:** Displays a number on your input to quickly identify the source
- **PATTERN:** Enables test pattern on the input. It allows you to start working without any plugged source
- **BLACK:** Turns your input to black
- **FREEZE:** Freezes/unfreezes your input
- **COMPOSITE SYNC LOAD:** Sets up to Hi-Z (default) or to a 75Ohm load your input , only available for analog signals.



Under the **HDCP** section, you can:

- Enable/disable the HDCP communication feature. When disabled, the input is seen by the sources as non HDCP compliant. This is useful for sources that HDCP-protect contents that don't need to be (Mac desktop for example).
- Read the HDCP status, very useful to know if the input HDCP communication is active or not.

Next is the **IMAGE** tab, where you can find all settings about the display of your input:

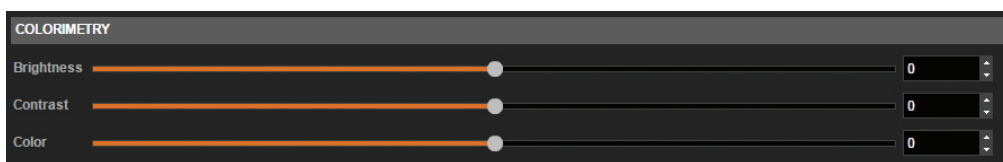

Under the **COLORIMETRY** section, you have:

- **BRIGHTNESS:** Sets up the luminosity level of your input
- **CONTRAST:** Sets up the contrast level of your input
- **COLOR:** Sets up the color level of your input (0:black and white, full: full color)
- **HUE:** Sets up the hue phase of your NTSC signal.

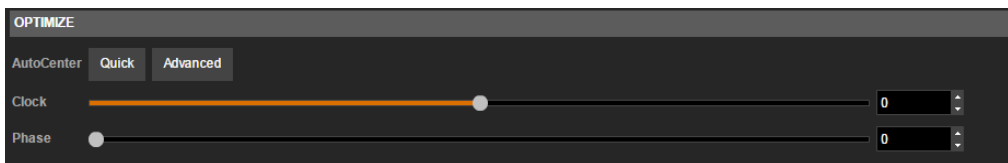

Under the **OPTIMIZE** section – only for analog signals, you have:

- **AUTO CENTER:** Automatic search of the right Clock and Phase of your input analog computer signal. In other words, it automatically searches for the first and the last pixel of the signal. There are two modes: a quick search and an advanced search typically launched when the source is rich in content such as a vertical burst.
- **CLOCK:** Sets up manually the clock of your input
- **PHASE:** Sets up manually the phase of your input

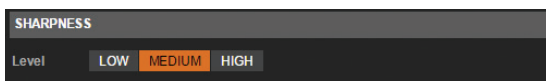

Under the **SHARPNESS** section, you have:

**LEVEL:** Details level of the image, applies more or less image processing to make a better result when the source is highly resized, it reduces the scaling artefacts.

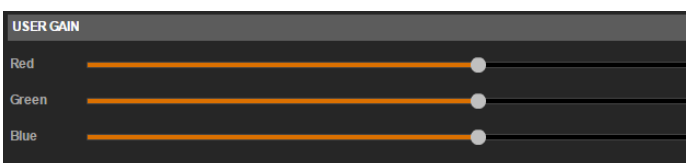

Under the **USER GAIN** section, you find:

- **THE RED/GREEN/BLUE:** Increases/decreases the Red/Green/Blue level of your input.

Under the **DEINTERLACER** section – only for interlaced signals , you have:

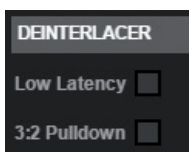

- **2:2:** Enables/disables the 2:2 feature. Should be enabled by default. The 2:2 is useful as it launches a specific frame/line algorithm when a 2:2 content is played.
- **3:2:** Enables/disables the 3:2 feature. Should be enabled by default. The 3:2 is useful as it launches a specific frame/line algorithm when a 3:2 content is played.

Next you have the **ASPECT** tab. All settings about the blanking and aspect ratio are available there:

Under the **BLANKING ADJUSTEMENTS** – only for analog signals:

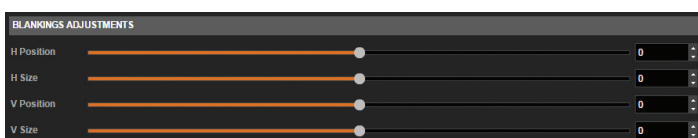

- **H&V POSITION SIZE:** You can manually adjust the input blanking with the V&H size or position. Only available on analog signals to correct the active area of the signal (for example to remove timecode).



### Under the ASPECT RATIO section:

- **ASPECT IN:** Selects the correct aspect ratio of your input (5:4 4:3 etc...). This setting doesn't exist when the input is set as native.
- **PREDEFINED CROP:** Chooses a specific cropped ratio if you use a source with black bands on top/bottom or left/right
- **ASPECT OUT:** Defines the way the image is displayed into a layer (full screen, centered, cropped or 1:1)
- **OVERSCAN:** Chooses to apply or not a predefined zoom on the image (use with CRT TV)

Next settings available on the **ASPECT** tab are:

- **CROP:** uses the Top, Bottom, Left and Right values to crop your input. A finder is also available. When activated, you can use the white rectangle to set up the cropped area accurately.

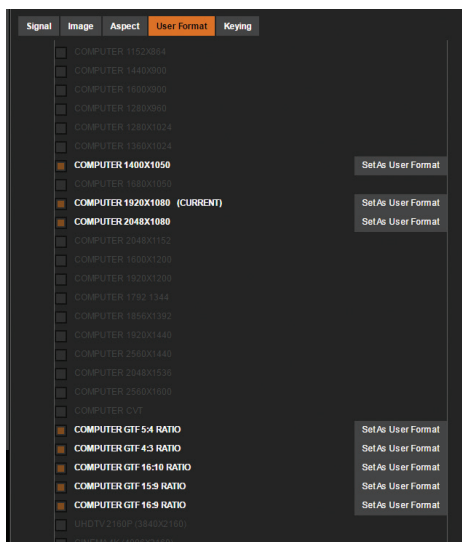
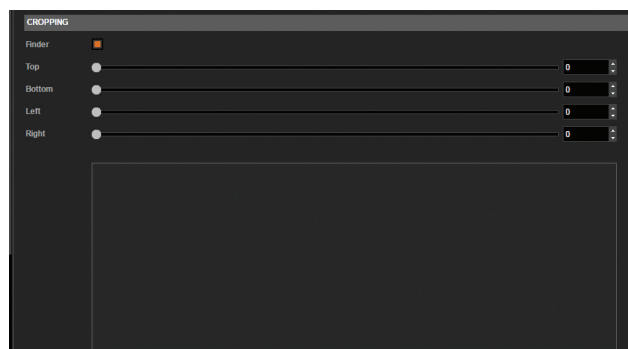

The next tab is the **USER FORMAT:**

In this tab, you can define what the input format exactly is. The input format is automatically detected by the **LiveCore™** unit but you can change it or force it. The available formats are close to the current one, in terms of lines. This is available only for analog computer formats.

## KEYING FEATURE

With the keying feature, you will be able to key easily a color space or a specific luma on an input.

A **LiveCore™ unit** offers an individual keying for each input. Into the input settings, find the keying menu:

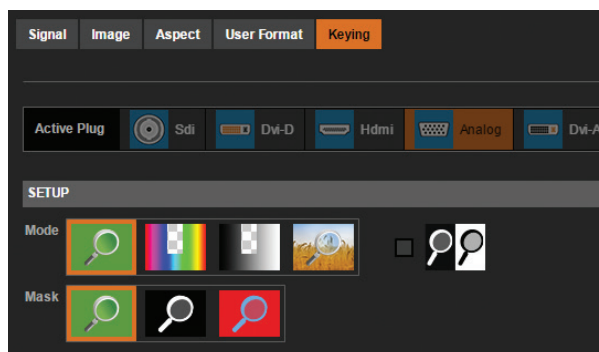

## YOU HAVE 3 WAYS OF USING THE KEYING:



- **COLORKILLER:** standard color keyer deleting a specific color space defined by user.



- **LUMAKILLER:** Luma color keyer deleting white colors whose luma level is included in the user defined range.



- **CREMATTE®:** The new algorithm of color keying developed by Analog Way. This keying will perform advanced effects on transparent items, smooth edge and color correction.

Keying setup can be done either by setting directly color references and tolerances or by using the color grab assistant. When using the assistant, select the color area you want to mask and click **ADD AREA**.

Color areas are cumulative, if the results are not satisfactory, click the Reset button and then grab another area.



- **INVERT BUTTON:** At any time you can choose to invert the actual keying using this button.

- **DSK TITLING:** After your keying, the DSK titling feature allows you to play with the transparency of your deleted pixels. After enabling this feature, simply adjust the opacity settings to make your keyed pixels more or less dark.

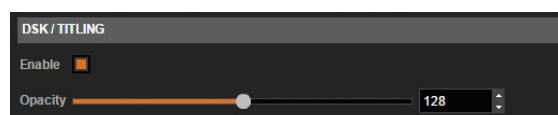

## HOW TO USE THE COLOR KEYING:

- Manually: Set the Hue and luminance to choose the color space you want to delete into your image.

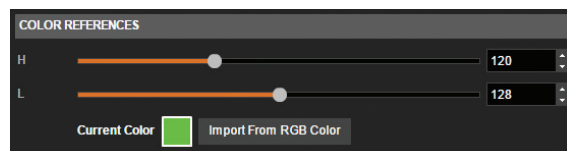

- Set it manually looking at the color change into Current color. If you want, you can quickly select a color from a color panel, clicking on **Import from RGB color**.

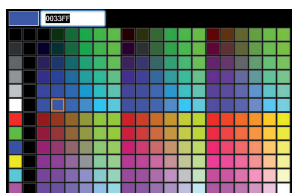
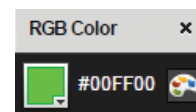

Then click on the color itself to obtain the color panel.

Once your main color is chosen, you can define a degree of tolerance around this color. The tolerance will define, around the main color, an area that will be keyed too.

**KEYING ASSISTANT:**

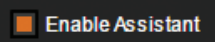
To enable the keying assistant click on: 

Then use the white square to define an area which exemplifies the color you want to key.

**NOTE:** You can use shift on your computer keyboard in order to size the white square.

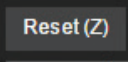
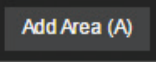
  For the first application, we advise you to reset all the previous keying settings. Click on **RESET** to reset all previous settings.

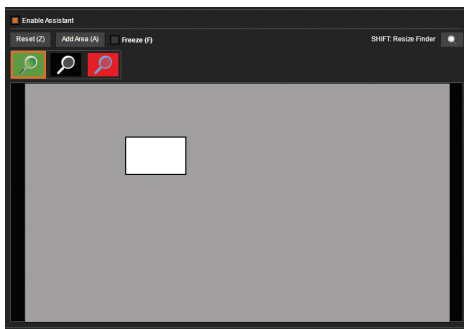

To start deleting, move your white square on your live image and then press **ADD AREA**. You can add several areas.



At any moment you can freeze the live content of your source using the **FREEZE** button.

Mask options are available if you want to visualize the keyed content versus the non-keyed content. The pixel color replacement used in each mask option is described in the chart below.

Only for CremaTTe®

| Mask  | Transparent pixels | Non transparent pixels | Semi-transparent pixels |
|---|--------------------|------------------------|-------------------------|
|  No mask       | Transparent        | Original pixels color  | Original pixels color   |
|  Black & white | Black              | White                  | Grey                    |
|  Red & blue    | Red                | Blue                   | Grey                    |

**NOTE:** The masks are really useful for configuring the Crematte keying, see below.

**HOW TO USE THE LUMA KEYING:**

Select the lumakiller and then adjust manually, or using to the assistant, the luma level:

Manually: Set the Luminance value or select it with the color panel clicking on **Import from RGB color**.

Then adjust to tolerance to increase the range of luminance levels around your reference luma.

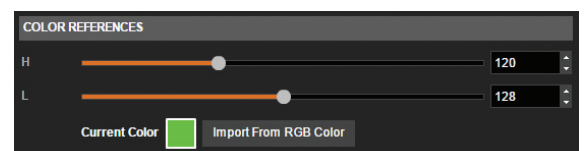
**ASSISTANT:**

The easiest way to find the exact luma you want to remove is to use the assistant. Simply move the white square to an area you want to remove and click on **ADD AREA** to determine the correct luma value.

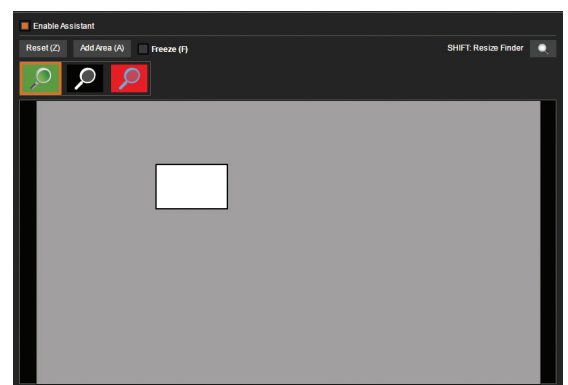



## HOW TO USE THE CREMATTE® KEYING:

The CremaTTe® algorithm was developed by Analog Way to perform a high quality keying. If your live source contains some transparent area or if you need to key a difficult video of people with wispy hair, you need to use CremaTTe® algorithm.

Using the CremaTTe® algorithm, we advise you to start by using the keying assistant.

1. Start to remove the main color using the white square in the keying assistant.
2. Remember that you can freeze the source, and that you can add several areas by simply clicking several time on **ADD AREA** button.
3. After some iteration, most of colors are deleted, enable the **RED & BLUE mask** to help you find any missed garbage on the screen.
4. At this point, with the mask enabled, you should have only **RED & BLUE pixels** on your live image.
5. **EDGE SMOOTHING**: the edge smoothing settings allow you to determinate some area where you want to add transparency. Adjusting the H S L values will display some **GREY pixels** around the edge of your live content. Those **GREY pixels** will later be rendered semi-transparent.
6. Adjust accurately the HSL in order to make transparent only the desired area. (A too high level will make transparent some solid area).
7. At this point, disable the mask and return to you original live image.

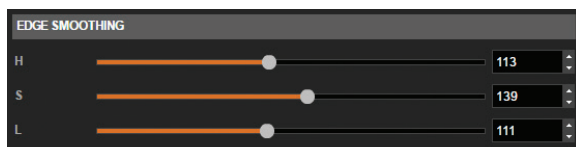

8. You can see that some area still have some color reflections. This can occur mainly on clothes and hairs. Adjust the **COLOR CORRECTION RATIO** using the Hue and Saturation settings to find the best result. Be careful of the color correction, a wrong setting can modify badly the color of skin. Try to find the best compromise between color modifications and reflect areas deleted.

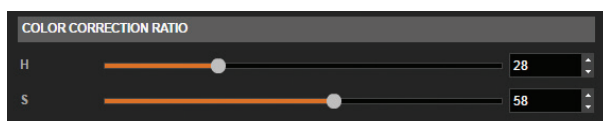

## 7.3.11 Library management

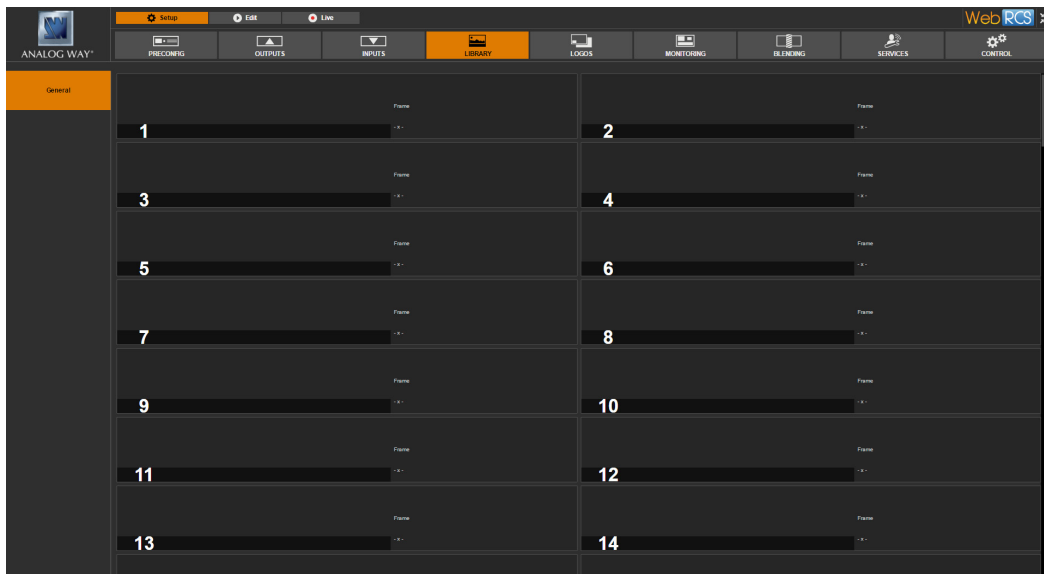

Under the **SETUP > LIBRARY** tab, you have access to 100 empty library slots that you can fill with your own frame and logo images.

### IMAGE UPLOAD

You can upload the following image formats to the library:

| Format | Download | Transparency support |
|--------|----------|----------------------|
| BMP    | Yes      | N/A                  |
| JPEG   | Yes      | N/A                  |
| TIFF   | Yes      | Yes                  |
| GIF    | Yes      | Yes                  |
| PNG    | Yes      | Yes                  |
| ICO    | Yes      | Yes                  |

To upload an image to the library, hover over an (empty) library slot and click on the **Upload Image** button 



The **Upload Image to Library** window will pop up.

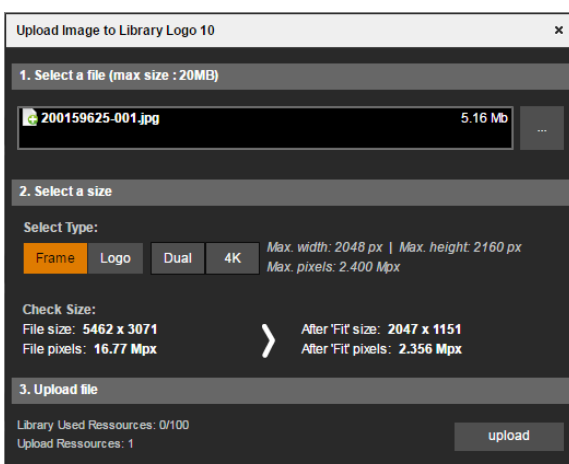

Browse for the image to upload from your computer and click on the **Upload** to upload it to the library.

## 4K AND DUAL-SIZE FRAMES

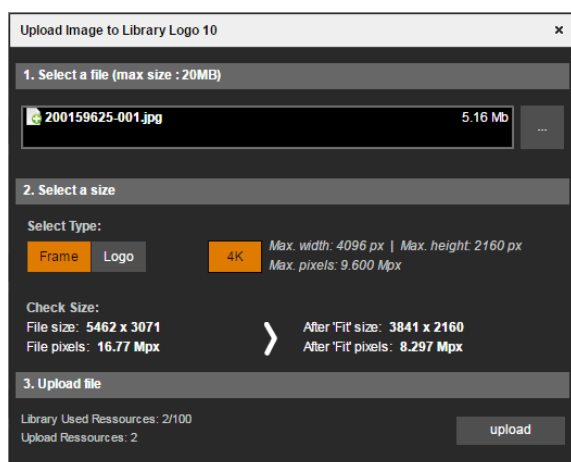

If the image size allows it, you may select the type of frame/logo to create from the uploaded image:

- **Frame:** upload as single frame (up to 2.4Mpx)
- **Logo:** upload as logo (up to 1.2Mpx)
- **DUAL:** upload as dual-size frame (up to 4.8Mpx)
- **4K:** upload as a 4K frame (up to 9.4Mpx)

The system will automatically fit the uploaded image to the selected Frame/Logo/Dual/4K type (check the **After 'Fit' size** and **After 'Fit' pixels** information right below **Check size** for more information).

4K frames and DUAL frames can be very useful for example when used as native backgrounds for 4K/Dual resolution displays (see the [7.3.7 Native background](#) section).

Please note that 4K frames and DUAL frames will require 2 frame slots and 2 layers to be displayed. This behavior is similar to using Dual-Link or Dual-Head live inputs. See [7.3.12 Logo management](#) for information on frame slots and [7.4.6 Logos and frame management](#) for information on layers.

## LIVE CAPTURES

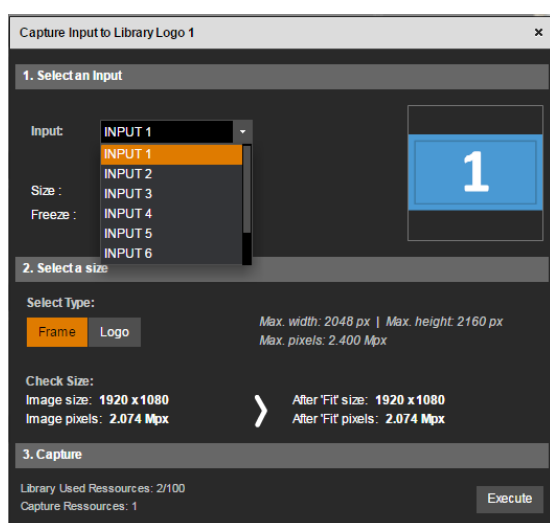

It is also possible to capture a frame or a logo from an input at a 1:1 resolution. To capture a frame or logo, hover over an (empty) library slot and click on the Capture button.  The Capture Input to Library window will pop up.

In the **Capture Input to Library** window, select the input and the type of capture (Frame or Logo) and click on **Execute** to start the capture. You can also use the **Freeze** button to freeze the input.

*Please refer to [7.4.6 Logos and Frames management](#) for more information on how to use frames and logos.*

## DELETING LIBRARY IMAGES

To delete a frame or logo from the library, hover over the library slot containing the frame or logo to delete and click on the **Erase** image button. 

Deleting the image will reset (empty) the library slot.

To delete all logos and frames in the library (empty the library), *please refer to the [7.3.16 Control management](#) chapter.*

## LIBRARY SYNCHRONIZATION (ADDITIVE MODULARITY LINKED MODE)

With additive modularity, you can link two **LiveCore™** units together in order to share their input and output resources (see chapter: [10.1 Additive Modularity Linked mode](#)).

Linking two **LiveCore™** units together will also allow you to share frame and logo resources, and therefore have access to a total of 8 frame and 8 logo resources (4+4 from the master device + 4+4 from the slave device).

To be able to share frame and logo resources however, you will need to synchronize the slave library to the master library. This way the master library will be the same on both devices, and you may simply upload

frames and logos via this one identical library (the master library).

Please note that the total number of available slots in the library remains 100, and that 4K and Dual frames

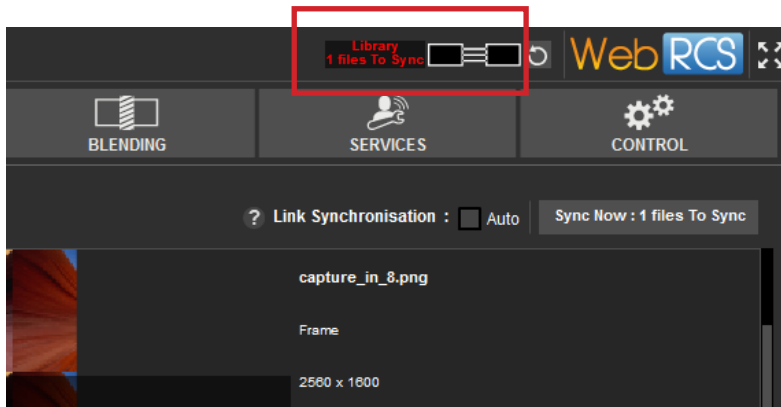

will still require 4 and 2 frame resources, respectively.

A notification will be displayed as long as a synchronization is required, and it will disappear as soon as the synchronization is complete. To start synchronizing the two libraries, go to the **Link Synchronisation** section (located on the right side corner of the **Library** page) and click on the **Sync now** button. The sync process time will depend on the number and size of frames/logos to synchronize, but you can carry on working while the sync process takes place. You can also enable **Auto** to automatically synchronize the two libraries every time a new frame or logo is added to the library.

## 7.3.12 Logo management

You can use frame and logo slots to preset your still images before using them with the device.

There are 4 frame slots and 4 logo slots available that you can fill with stills from the library. Frame slots will accept both frame and logo stills, whereas logo slots will accept logo stills only.

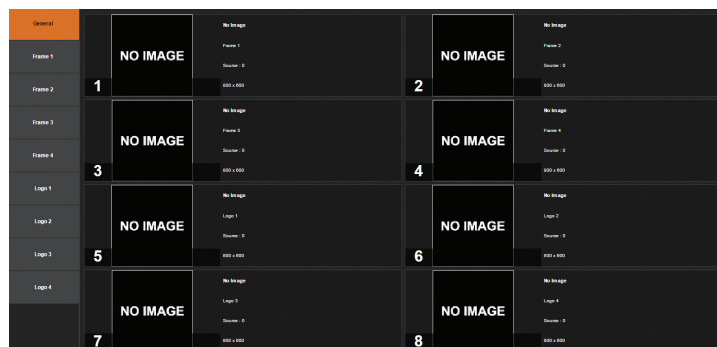

### FRAME/LOGO SLOTS

The **Setup > Logos > General** tab allows you to review all frame and logo slots.

To access a particular frame/logo slot, hover over the frame/logo slot and click on the **Setup** button, or select the frame/logo slot directly from the left side toolbar (tabs **Frame 1**, **Frame 2**, ..., **Logo 3**, **Logo 4**).

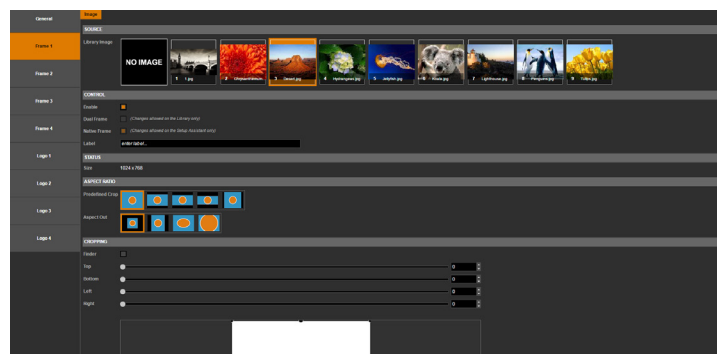

Once the frame/logo page is loaded, you have access to the following frame/logo slot settings:

- **SOURCE:** Assign an image to the frame/logo slot. Please note that only frame slots #2 and #4 will accept 4K/Dual-size images, and that when slot #2 (and/or #4) is used for a 4K/Dual-size image, slot #1 (and/or #3) is disabled (this behavior is similar to using 4K/Dual live inputs). The text **(4K)/(DUAL)** will tell you which library images are 4K/Dual-size.
- **ENABLE:** Enable or not this slot
- **DUAL FRAME:** Status to indicate if the Dual Frame feature is currently in use. The Dual Frame feature will be enabled automatically when a Dual Frame or a 4K Frame library image is assigned to a Frame slot and, while the Dual Frame feature is enabled, the previous Frame slot will be disabled.
- **NATIVE FRAME:** Shows you if the native background is enabled and which output is chosen. You can change this parameter into the Setup assistant only.
- **LABEL:** Rename the frame
- **STATUS:** Allows you to see the resolution of the image
- **ASPECT RATIO:** Set up the aspect In, Out and crop your frame.

### USING FRAME AND LOGO SLOTS

Only images in frame and logo slots will be available for use during **Edit** and **Live**.

You can fill all 4 frame and 4 logo slots with stills from the library to take the most of using Frames and Logos with your device.

At any time, you can come back to the **Logo** section and fill your frame/logo slots with new Frames and Logos.

See [7.4.6 Logos and Frames management](#) for more information on how to use Frames and Logos.

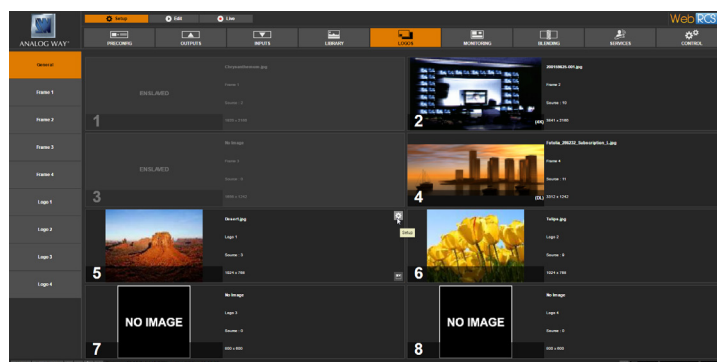

### 7.3.13 Monitoring management

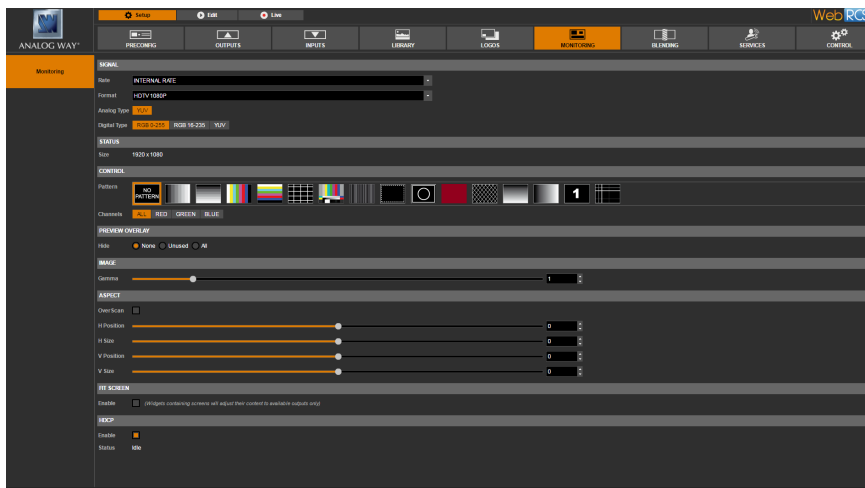

The Monitoring output allows you to have a full Preview of your different outputs but also your sources.

In addition, you have access to a lot of status shortcuts directly on the screen like **HDCP** status, **KEYING** status, **FREEZE** status etc.

To set up your Monitoring output, you can choose:

- **RATE**: Choose the output rate
- **FORMAT**: Choose the output format
- **TIMING**: Choose the signal timing format
- **TYPE**: You can choose the type of output synchronization on analog plug or digital plug. Choose C-YC to enable composite PAL or NTSC on composite plug
- **STATUS**: Access the output status
- **PATTERN**: A pattern is available to test your output without any input selected
- **FLICKER**: Choose the value of the flicker filter to disabled the flicker effect on your screen (interlaced lines effect)
- **GAMMA**: Correct the non linearity of the display luminosity
- **ASPECT**: You can enable the overscan and set the position and size
- **FIT SCREEN**: If enabled, monitoring widgets containing screens will adjust their content to available outputs only (that is, available on the device). This feature is interesting when creating screens with multi-outputs dimension but filled with only one output. When enabled, the widget will only display the output and not the blank areas of the screen.
- **HDCP**: Enable/disable and see the **HDCP** status

Depending on the output format chosen previously, all settings might not appear.

### 7.3.14 Blending management

To have access to the blending management, you first need to build a screen with multiple outputs. This is configured in the **PRECONFIG > SCREENS** section.

**SmartMatrix Ultra** devices do not have any blend capabilities. **NeXtage 16 - 4K**, **Ascender 16 - 4K**, **Ascender 32 - 4K - PL** & **Ascender 48 - 4K - PL** devices can create blends with any number of available outputs, both horizontally and vertically.

To setup a soft-edge blend, proceed with the **BLENDING** section:

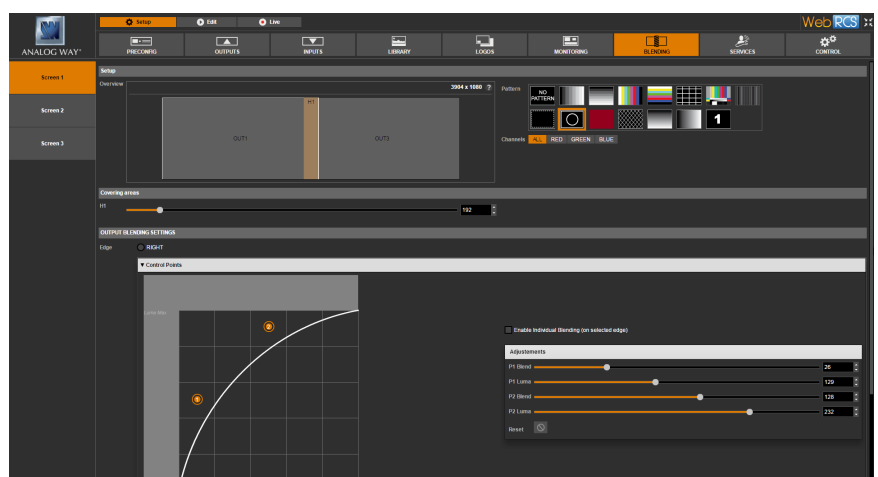

To setup an effective blend, you will first need to physically align the projected images so they are square with each other. Remember that you can adjust the number of lines and rows on the **LiveCore™** grid test pattern to assist you.

Then, the covering area can be adjusted in pixel in real time thanks to the Soft Edge centering test pattern. After enabling the Soft Edge centering test pattern, simply align the two lines one on the other, increasing the covering value. You can go up to a covering pixel size of 2048px to allow for 4K Soft-Edge Blending formats.

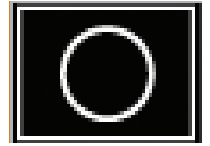

Two lines do not move and two other lines move when you increase the covering value. The aim is to align exactly the half lines in order to have 2 full lines.

If you don't see 4 half lines when increasing the covering area, click on the left/right part of your Soft Edge to display the blending adjustments. Then disable the blending for the left part then the right part. Your pattern will display the 4 half lines now.

Once your covering area is defined properly, you need to adjust, for left and right sides, the black levels for each non-overlapping portion of the blend.

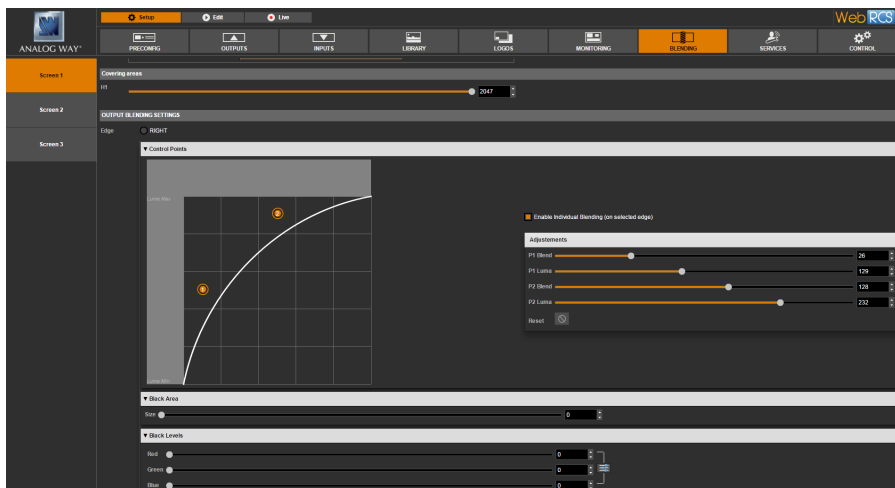

Click on the left/right side into the overview of your Soft Edge, some settings appear. Then adjust the black levels for each side using the R,G,B level to make each non-overlapping part of the projection as bright as the overlap zone.

The goal here is to have your Soft Edge area with the same level of black on the left, right and overlap zones. For best results, you should darken the room as much as possible when making this adjustment.

The Black Area adjustment can be used to remove the occasional few pixels of white band that can appear at the border of the overlap zone.

At the top of the page, select the overlap zone, then click on "Enable blending" in order to activate the blending curves on both adjacent edges. (If a non-overlap zone is selected, you will be offered to "enable individual blending" on only one edge. You can edit the curve by moving the 2 points. Typically, this curve does not need to be adjusted from the default settings.

## 7.3.15 Services management

### UPDATE:

You have several way to update your **LiveCore™** unit:

- by using the upload updater:  
Click on “Select a file on your disk” button in order to open the directory file on your computer. Simply select the file you take from Analog Way’s servers and click ok. Then click on GO to launch the update.
- by USB key:  
Please note that you also can update the device through the USB Port, please refer the *chapter 8.1.1 Front panel update*.

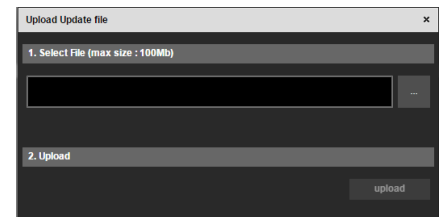
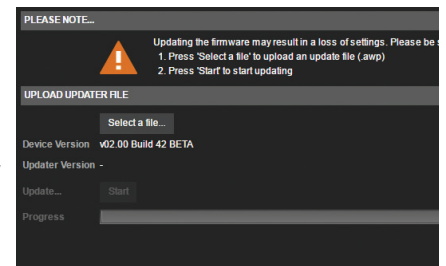

### IMPORT/EXPORT:

The Export section allows the user to generate and download on a computer a backup file. This file can be customized; it can include the device configuration and the logo library (that also can be loaded), the device logs, snapshots and statistics (only for the export).

The Import section allows the user to upload a backup file. Push upload button then choose the directory on your computer. Please note that the file size is limited to 400MB when using the **Web RCS**.

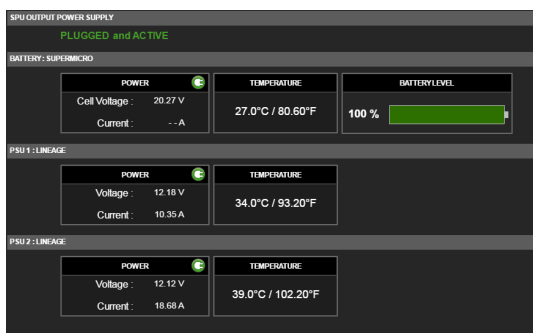
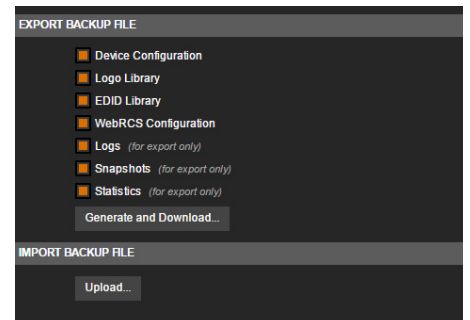

### SPU: (only when a SPU is plugged)

When a Secure Power Unit is connected to the device, the SPU is displayed. It gives a feedback of the SPU status, the battery temperature and charge, the two power supply unit voltage/current and temperature.

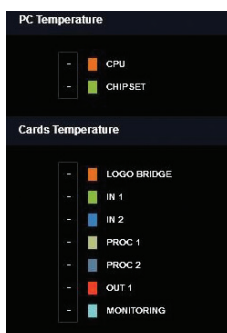

### TEMPERATURE:

A temperature notification will pop up if your device reaches some critical temperature. The temperature section will allow you to check overheating alarms on device components, and take action whenever required:

- P** - **Preventive standby alarm:** sending the device to standby is strongly recommended.
- F** - **Forced safety standby alarm:** the device will be sent to standby if the alarm persists for over 5 minutes.

Please contact your local technical support if the alarm persists after a period of cooldown.

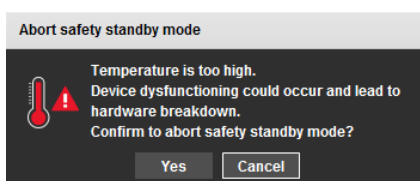

**NOTE:** You can abort forced safety standby mode and overwrite all temperature alarm notifications by clicking on the **Abort safety standby mode** button. **!/ \ Be aware:** You will no longer be notified about temperature alarms until next reboot, and forced safety standby will not occur.



## HARDWARE INFORMATION:

Here is a summary of all the cards information, Name ID etc... This is only for maintenance purpose. In case of issue, it will provide information to the technical support.

| Web RCS   |            |        |           |        |          |     |  |
|---|------------|--------|-----------|--------|----------|-----|--|
| ANALOG WAY  |            |        |           |        |          |     |  |
| <span>Setup</span> <span>Edit</span> <span>Live</span>  |            |        |           |        |          |     |  |
| <span>PRECONFIG</span> <span>OUTPUTS</span> <span>INPUTS</span> <span>LIBRARY</span> <span>LOGS</span> <span>MONITORING</span> <span>BLENDING</span> <span>SERVICES</span> <span>CONTROL</span> |            |        |           |        |          |     |  |
| Update  |            |        |           |        |          |     |  |
| CARDS   |            |        |           |        |          |     |  |
| Name  | Id         | Serial | Mandatory | Ref    | DateCode | Rev |  |
| LOGO BRIDGE   | 0x0FA6EFD  | 653    | 1         | 210218 | 1523     | 1   |  |
| IN 1  | 0x0FA8A70  | 386    | 1         | 210244 | 1528     | 0   |  |
| IN 2  | 0x0FA8113  | 382    | 1         | 210244 | 1528     | 0   |  |
| IN 3  | 0x0FA8411  | 393    | 1         | 210244 | 1528     | 0   |  |
| PROC 1  | 0x0FAE58E  | 324    | 1         | 210252 | 1539     | 2   |  |
| PROC 2  | 0x0FA93A   | 331    | 1         | 210252 | 1539     | 2   |  |
| PROC 3  | 0x0FA944   | 327    | 1         | 210252 | 1539     | 2   |  |
| PROC 4  | 0x0FB2B42  | 330    | 1         | 210252 | 1539     | 2   |  |
| PROC 5  | 0x0FB2B2F  | 325    | 1         | 210252 | 1539     | 2   |  |
| PROC 6  | 0x0FA2684  | 337    | 1         | 210252 | 1539     | 2   |  |
| OUT 1   | 0x0FADDD   | 298    | 1         | 210264 | 1528     | 0   |  |
| OUT 2   | 0x0FA6650  | 317    | 1         | 210264 | 1528     | 0   |  |
| MONITORING  | 0x0FA873   | 766    | 1         | 210263 | 1524     | 0   |  |
| FDP   | 0x0FB258E  | 351    | 1         | 210209 | 1518     | 0   |  |
| FA/DISPLAY  | 0x0FA8488  | 683    | 1         | 210216 | 1526     | 1   |  |
| FA/KEY  | 0x0AE2852  | 127    | 1         | 210223 | 1531     | 0   |  |
| FRAMELOCK   | 0x4390C150 | 613    | 1         | 210234 | 1507     | 1   |  |
| LINK_UP   | 0x0FB115A  | 462    | 1         | 210219 | 1519     | 0   |  |
| LINK_DOWN   | 0x0FAF535  | 436    | 1         | 210220 | 1519     | 0   |  |

## TECHNICAL SUPPORT:

You will find contact for our local technical support departments located throughout the world.



## 7.3.16 Control management

### Network

The web interface loaded into the unit uses the IP configuration.

Under **INTERFACE**, you can define a new:

- IP address
- Netmask
- Gateway
- Port: Choose the port
- Protocol: Choose TCP (by default) or UDP

Choose DHCP if you want an automatic IP address assignment.

Under the Web RCS feature, you can define the communication port to use for third party control applications.

You also have an indication on the number of connected devices.

For any information about the Third Party Protocol, please *see chapter: 9. Additional Remote Control Systems.*

### Emergency presets:

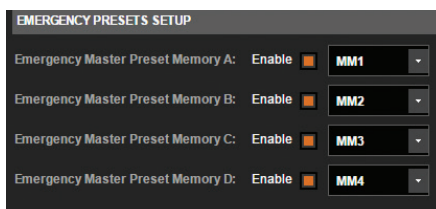

The emergency presets allow you to recall quickly some Master Memories (*see chapter: 7.5 Live / Master memories*). You have the possibility to have up to 4 emergency memories. Please enable the feature then choose for each line a master memory which will be recalled in case of problem.

By enabling the emergency memories, some new buttons will appear into the Live edition:

A(MM1)

B(MM2)

C(MM3)

D(MM4)

If you click on A, B, C or D, it will recall automatically the MM1 MM2 MM3 or MM4 on the main screen.

### EDID Management:

The EDID manager is composed of three parts: the Outputs EDIDs, the EDID Library and Inputs EDID Settings. The Outputs EDIDs contains the EDID read from output devices such as video projectors or monitors in order to enable them to be saved. EDIDs can be refreshed, one by one or all together. These EDIDs can be saved into the EDID Library thanks to a simple drag'n drop in the EDID Library. In the Library, the ten first EDIDs are default EDIDs ; They can't be modified; their protection is symbolized by a lock. The twenty-two others can be either uploaded from a computer or saved from Outputs EDIDs.

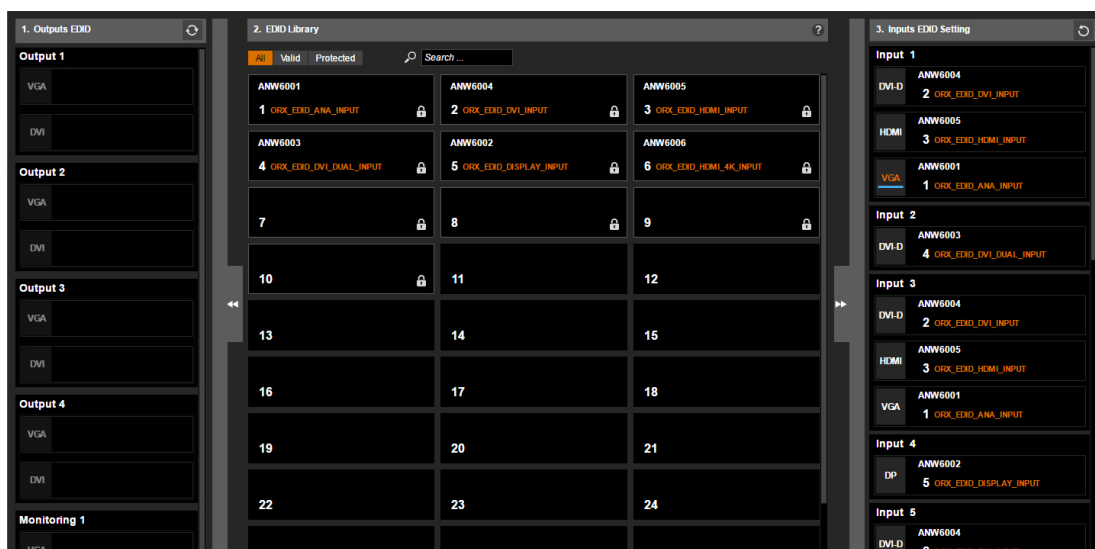

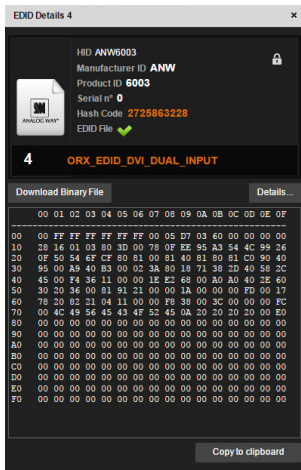

Details can be seen clicking on the magnifying glass.

Inputs EDID settings are EDIDs assigned on the inputs. There are default EDIDs, it can be modified by dropping EDIDs from the Library. Each EDID (one per input type, for each input) can be reset to factory. There is also a global reset for all inputs.

### Tally-GPIO:

The Tally-GPIO is a set of inputs/outputs to control the device externally and have a feedback from the device.

Here is the pin assignment for GPIO:

The pins 1 and 2 are dedicated to turn on and off the device; a switch has to be placed between these two pins.

It works as the front panel switch: when the device is on, close the switch will request the device to power down. If the switch remains closed more than four seconds, a forced power down is performed. When the device is off, close the switch will turn on the device.

Only a wire with a simple switch can be connected.

|    |                     |
|----|---------------------|
| 1  | ON/OFF switch pin1  |
| 2  | ON/OFF switch pin2  |
| 3  | GPI negative        |
| 4  | GPI positive        |
| 5  | GPO return (common) |
| 6  | GPO 1               |
| 7  | GPO 2               |
| 8  | GPO 3               |
| 9  | GPO 4               |
| 10 | GPO 5               |

### GPO:

GPOs are optically isolated MOSFET, working as mechanical relays.

They all have a common pin (the 5<sup>th</sup> pin).

The polarity of GPO1, 2, 3, 4 and 5 have to be configured: normally open or normally closed.

The mode of the GPO can be:

- **FREE:** manual mode, the state can be defined by a user action through the Web RCS or by an automation controller)



- **TALLY:** automatically generated, before or after a **TAKE** operation.

If automatically generated, it can be just before the transition (at the beginning of the transition effect) or after (when the effect is finished).

In TALLY mode, one or several inputs have to be chosen for a screen, then when used on this screen, a GPO/TALLY level change will occur.

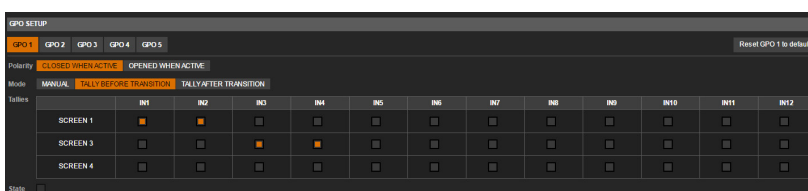

Each GPO can sink a current of up to 300mA maximum in the closed state and can accept up to 48V in the opened state. The current leakage is less than 1µA when opened and the resistance is less than 2 ohms when closed. The GPO can be reset to its default values.

**GPI:**  
 The optically isolated GPI allows the user to drive the device externally. There are two pins: one positive and one negative. The way to trigger it is to provide a current (10mA/3V min and 45mA/24V max). The GPI is protected over polarity inversion. There are two activation polarities: the input can be active when powered or when unpowered.

The mode can be :

- **FREE:** manual, not linked to an action, driven by automation

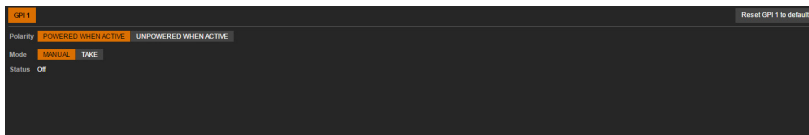

- **TAKE:** when input is active, a TAKE is generated on one or several screens.

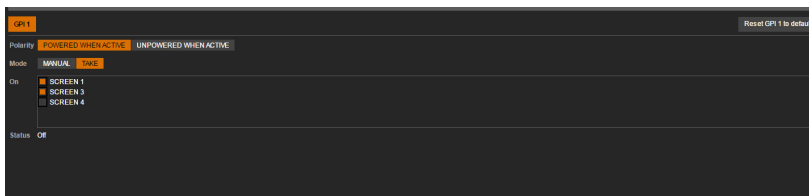

The GPI can be reset to its default values.

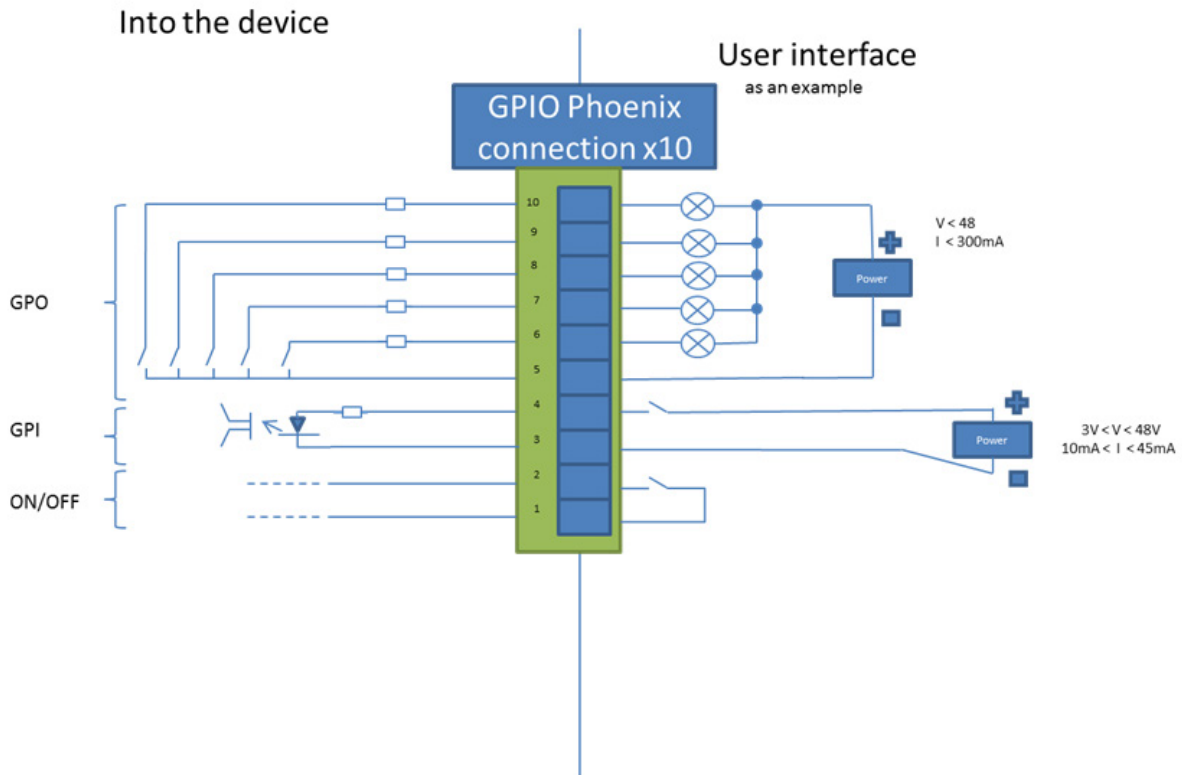

## Auto Calibrate

Click on start to launch an auto calibration of colors, on your analog input/output chips. (See chapter: **11. Maintenance and support**)

## Erase memories

Into this section, you can erase individual settings.



- Erase input settings memory: All input settings will return to their default value. This includes image, aspect, user format and keying parameters.
- Erase preset memories: All preset memories will return to their default value.
- Erase monitoring layout memories: all saved monitoring layout configuration will be erased, the monitoring layout will be the default one.
- Erase library logos: All saved logos and frames will be deleted from the library that can contain up to 100 still pictures.
- Erase library EDIDS: All EDIDs saved on the library free slots will be deleted.
- Erase library sequencer: all sequences saved on the sequencer library will be deleted.

Please note that a second click on **Start** is required in order to confirm the erase.

## Factory reset

**Configuration default value:** click on **START** (two times) to reset all standard parameters of your device to default settings.

- This setting does not reset the network/link settings.
- Library frames and logos will not be erased, the device will reboot after this operation.

**Factory Reset (Out of the Box):** click on **START** (two times) to reset all use parameters of your device to default. After rebooting, you will find your unit in the same state as when you opened the box for the first time.

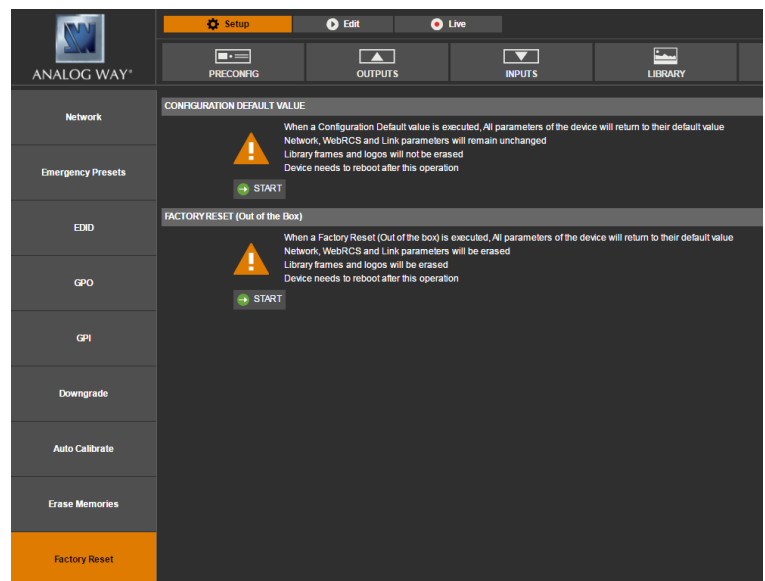

- **This operation will reset the network and link settings.**
- This operation will erase all libraries including the frames and logos library images.
- The device will reboot after this operation.
- This operation can also be found in the front panel.

**NOTE:** If your device has trouble initializing, press and hold the **ENTER+EXIT** front panel keys during initialization in order to start-up the device in factory fail-save mode. This mode will allow you to export a backup file of your device that you can then send to **Technical Support** for inspection. Proceed to reset your device as-is out of the box with **Factory Reset**.

## 7.4 Edit

### 7.4.1 Layer management

When you enter into the Edit menu, you will encounter a display of the program and preview windows for one destination screen, as well as access to select the sources, layer properties, and presets.

In this example, we are viewing the Screen 1 Program and Preview. The following example can be used for any other screen.

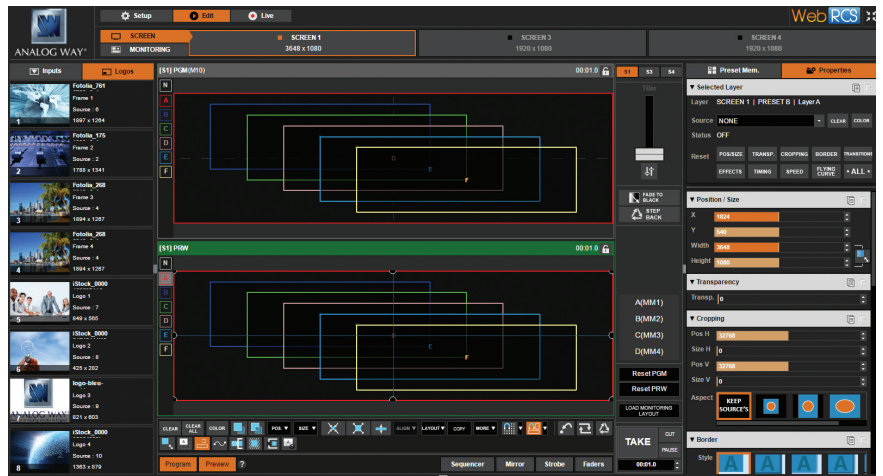

To display an input in one of the available layers (A, B, C, D, ...), drag and drop the input from the Inputs tab on the left side toolbar to the layer on the chosen screen. You can also select the Logos tab and drag and drop a logo or frame to the layer to display a logo/frame in the layer.

As an alternative to dragging and dropping directly onto the layer wireframe, you can assign a source to a layer by dropping the selected source into the layer letter icon, shown on the left edge of each screen.

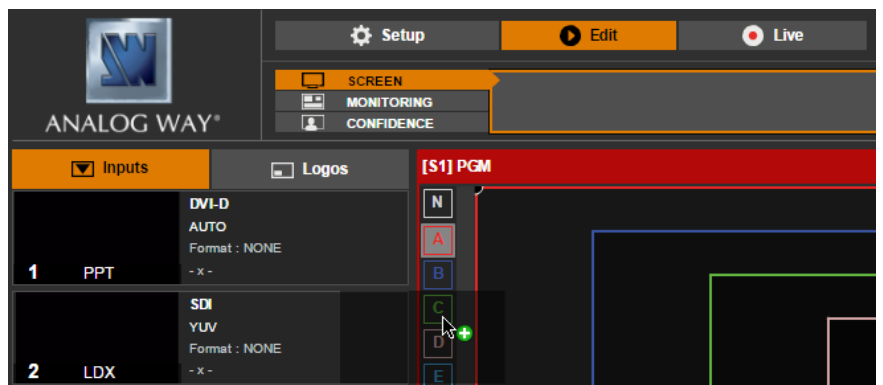

This can help if another layer is covering the layer you are trying to access. You can assign inputs to layers directly on Preview or Program. The source assignment is also available on the layer settings.

You now have sources assigned to some layers. When a layer contains an input, the live thumbnail image from the live source or frame is displayed within the layer. When the layer is empty, it is displayed by an empty wireframe.

You can use the “Hide unused Layers” feature to hide layers which are empty. To clear a layer, remove the input from a layer by pressing the “CLEAR” button in the bottom toolbar, or the delete key on your keyboard (FN+Delete on a mac).

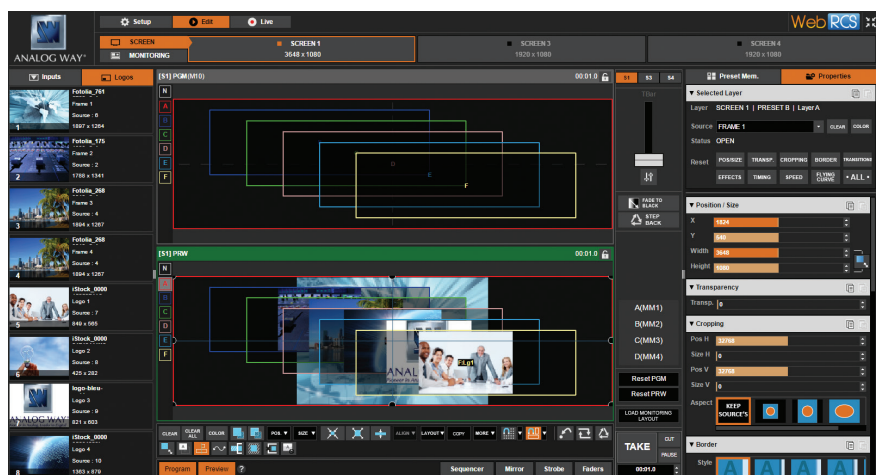

In this example, different inputs are assigned to each of the 6 layers into the Screen 1 Preview. Pressing the **TAKE** button on the bottom right side will update the Program screen based on the configuration that's been arranged in Preview.

The Preview screen is now displayed into the Program screen. By default, the unit works with the **PRESET TOGGLE** mode. That means, after a **TAKE**, the Preview becomes the previous Program. While in **PRESET TOGGLE** mode, pressing TAKE repeatedly will alternate the Program screen between two different looks.

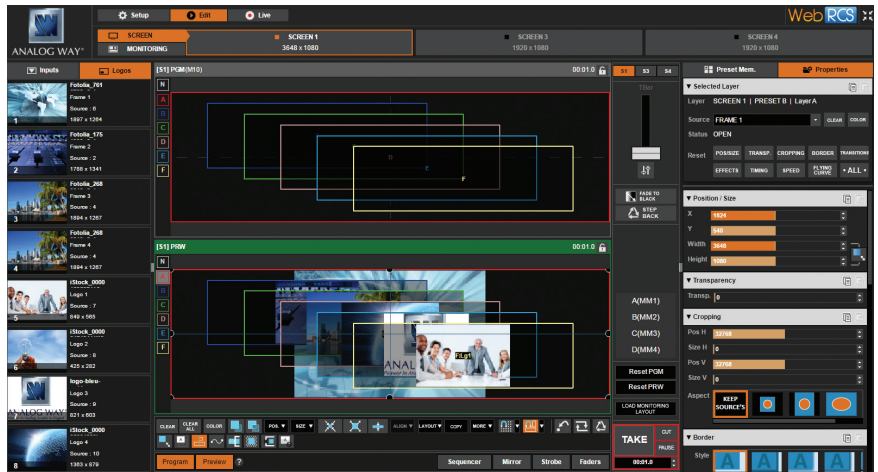

In order to have an overview of showed sources, a red line (for PROGRAM) and a green line (for PREVIEW) are displayed under the thumbnail of the source.

## 7.4.2 Layer properties

### Multiple layer selection

The **Properties** tab on the right side toolbar allows you to access the layer properties tools. You can use the layer properties tools to perform changes on a layer or a selection of layers. Click on a layer or on a layer letter icon to select a layer. Use SHIFT+click (or CTRL+click when using the layer letter icons) to add a layer to the selection. If the layer is already selected, SHIFT (or CTRL) + click will remove the layer from the selection.

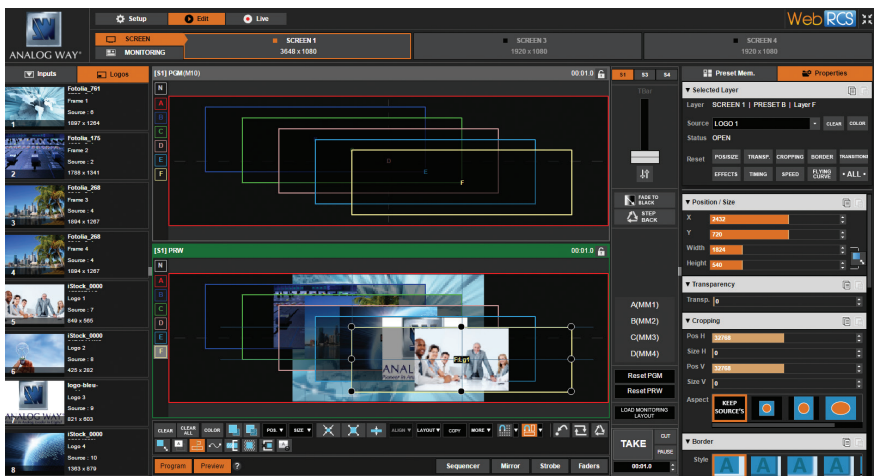

### Selected layer

Once you have selected a layer, the Selected Layer section will display the following status information: selected layer(s), input source and next transition status. When multiple layers have been selected, the first selected layer is **highlighted in orange** and only the input source and the transition status of the first layer in the selection is displayed.

**Reset buttons:** These buttons allow you to reset each layer attribute group (Pos/Size, Transparency, Cropping, Border, Transitions, Effects, Timing, Speed or Curves) or you can choose to reset all settings for the selected layer in one click using the **ALL** button.

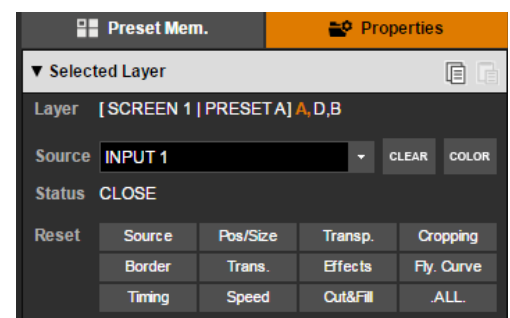

On each top right side of each Layer property attribute group, you will find copy/paste icon that enable to copy/paste settings from one layer to another one.

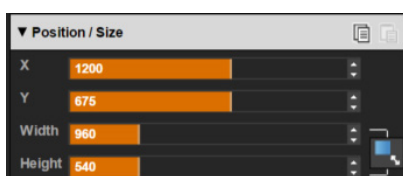

### Position/Size

The Position and size adjustments give pixel accurate control over the position and size of each layer. Adjust the size horizontally (X) or vertically (Y), then adjust the width and the height of your layer. You can use the cursor or directly enter a value. To keep the aspect ratio by using the cursor, please select the **KEEP ASPECT RATIO** button. You will find it on the right of the width and height cursors.

Please note that on the **Ascender 48 - 4K - PL** (Ref. ASC4806-4K-PL), the axe Z can be modified as well as the layer anchor point. *Please refer to the [chapter 7.6 How to operate Perspective Layers on the Ascender 48 - 4K - PL](#) for more details.*

### Transparency

Use the Transparency to give at the layer a semi-transparent effect. A setting of 0 is fully Opaque, meaning no transparency is applied. This setting can be used to use a layer as a watermark on another. To remove part of the source for a lower third see the input Keying section.

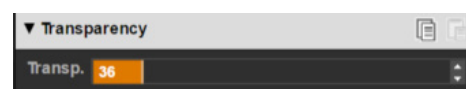

### Cropping

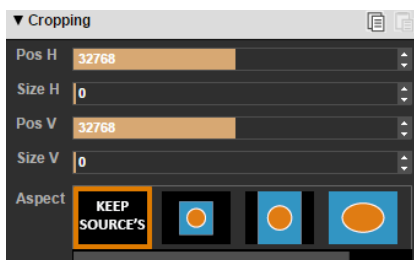

The Cropping feature allows you to cut into the image to remove the part you don't want. Be sure to adjust the crop size horizontally or vertically before adjusting the position to display only the desired content. The position parameter has no effect without a change in crop size. This crop setting is a layer crop, which affects any input assigned to this layer. (For additional crop options, see the **Input > Aspect setting**)

The Aspect Override setting allows you to override the Aspect Out setting assigned to each input with one configured for this layer only. Any input assigned to this layer will utilize the Layer's Aspect override setting instead of the one assigned to the input. Options include 1:1, Centered, Fullscreen, and Cropped. See the **Input > Aspect > Aspect out** for more information.

### Borders

You can choose amongst 5 types of border patterns for your layers: **EDGE**, **SMOOTH**, **SMOOTH EDGE**, **SHADOW**, or **SMOOTH SHADOW**.

For each pattern, you can further adjust border settings like color, alpha transparency, width/height, H/V position, and you can also enable or disable the Rounded corners feature (see also preset borders in chapter 7.3.8 The Miscellaneous section). Simply select a pattern to adjust the layer border properties, or select **NONE** to display no border.

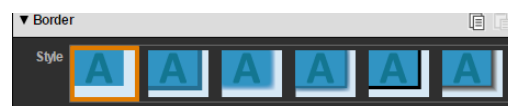

### Transitions

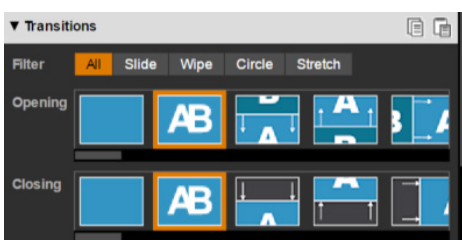

In the Transitions section, you can select an opening and closing effect to be used on each layer, including Cut, Fade, Slides, Wipes, Circle wipes, and Stretch effects. The filter allows you to limit which transition style options will be displayed.

Each layer can be defined by an opening and a closing transition. The opening effect will be used when the layer switches from one source to another or when the layer is not present on the screen and appears.

The closing effect is used when the layer is leaving the screen.

To set up the duration of the transition, please see below the timing and duration settings.

**Note:** The LiveCore™ unit will automatically perform layer movement transitions (Flying Zoom) if a source or layer remains on the screen between program and preview. If you want to force the layer to use the closing transition and the new opening transition, see **FORCE TRANSITION** into the next section.



### 7.4.3 Layer settings

The layer settings section includes special layer properties and effects, such as flip and force transition.

#### Force transition

The Force Transition button disables the “Flying Zoom” transition effect which is automatically used when a source or layer remains on the screen during a transition. Enabling the Force Transition, it forces the on-screen layer to use the closing transition and then use the opening transition to bring the layer or source back onto the screen.

For example, disabling force transition, a PIP of camera 1 moved across the screen will move and resize to the new position. By applying Force Transition to the layer on preview which has the new position, it will force the unit to use the closing transition (ie: fade out) for the on-screen PIP of camera 1 and force the PIP that is entering from preview to use the opening transition (ie: fade in).

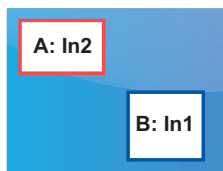
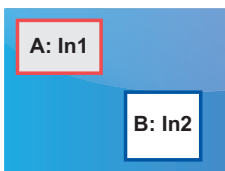
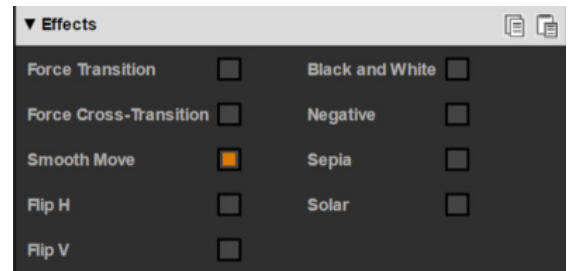

#### Force Cross-Transition

Enabling this function, you will disable the flying PIP feature. You will force the transition of the source into the layer instead of using the flying PIP.

Going from the first picture to the second picture:

With the force cross transition, layers stay in position and each layer fade the sources. Without the force cross transition, there is no fade, the layers fly until their final destination.

#### Smooth Move

Enable the Smooth Move to perform a smooth transition with acceleration on the movement on the selected layer. Disable the Smooth Move if you require a constant speed movement.

#### H&V Flip

The H&V Flip setting displays the layer source mirrored across a horizontal or vertical axis. The entire picture will be flipped.

#### Black&White, Negative, Sepia and Solarize effect:

A variety of image effects can be applied to the selected layers. To use these effects, click on the selected effect to have the result into the selected layer on program or preview. Each image effect can be activated separately or simultaneously and are saved as part of the presets. The affect will be applied gradually during a transition.

#### Flying Curve: Parabolic

Define the path that the PIP will move: straight, parabolic or user defined motion (beziers two points type). Parabolic motion applies a clockwise arc to the movement. Bezier Flying curve motion is configured with the Bezier Drawer setting and is defined by two points which define the curve that the layer will take as it moves from the current position on program to the new position defined on preview.

Please note that on the **Ascender 48 - 4K - PL** (Ref. ASC4806-4K-PL), the depth of the PIP during the transition can be modified. *Please refer to the [chapter 7.6 How to operate Perspective Layers on the Ascender 48 - 4K - PL](#) for more details.*

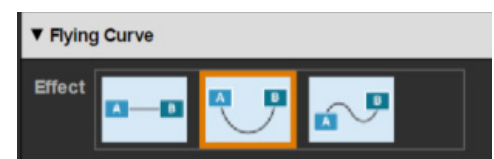

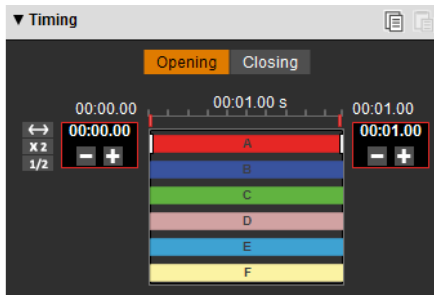

### Timing

The Timing section allows for individual setting of the opening and closing effects of each layer in a particular preset. The overall preset duration timing is defined next to the Take button, it defines the total duration of the transition.

You can adjust the beginning, the end and the duration of each layer transition within the overall preset duration. Simply click on the selected layer bar and adjust the start and the end of the transition or using plus and minus buttons, then move the bar, by clicking on it, to place your transition into the total transition duration.

The opening timing affects only the opening transitions used when a layer is entering the screen or transitioning to a new source. The closing transition timing affects only closing transitions used when a layer is leaving the screen.

### Speed

When the layer is flying over the screen, you can define a nonlinear speed depending on its position during the transition. The speed of the transition is also impacted by this parameter. You can set the starting and ending speed. To use this setting, the smooth move has to be enabled.

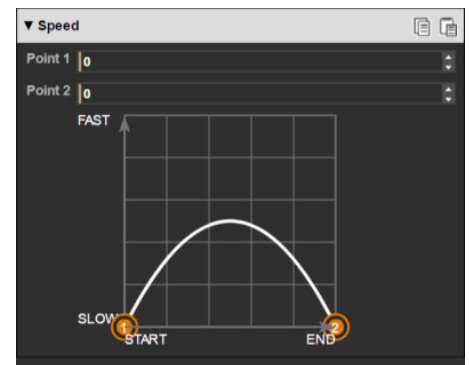

### Cut & Fill

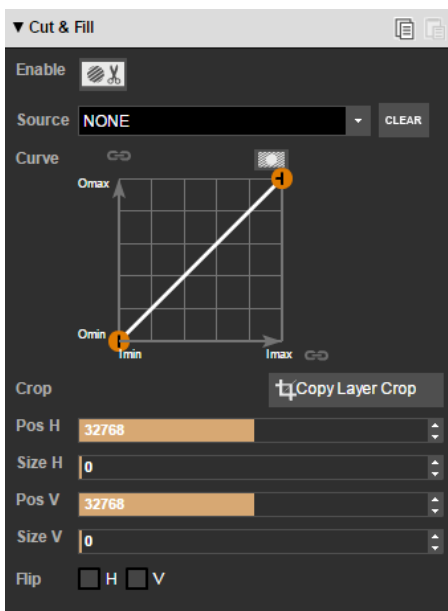

The Cut & Fill feature allows keying the content of a layer using an input or a still picture (frame or logo) as the alpha channel.

Usually, the Cut content (the mask), is a grey level content: the darker the grey level, the more transparent the Fill content.

If a colored content is used as Cut content, the Luma level of the Cut content is used to key the Fill content.

To enable the Cut & Fill feature for a layer, select a Fill layer in the chosen **Edit/Live** screen. Please note that since the Cut & Fill feature requires 2 layers (one for the Cut and one for the Fill), only layers A, C, E ... can be used for the Fill content.

Go to the layer **Properties** tab and scroll down to **Cut & Fill**.

Click on the enable Cut&Fill button to enable this feature.



A small area appears at the top right corner of the layer, indicating that Cut & Fill is enabled on the layer.

Select the **Source** for the Cut, or drag and drop the source from the **Inputs/Logos** tab into the small Cut&Fill area. A snapshot of the Cut source will appear in the small Cut&Fill area.

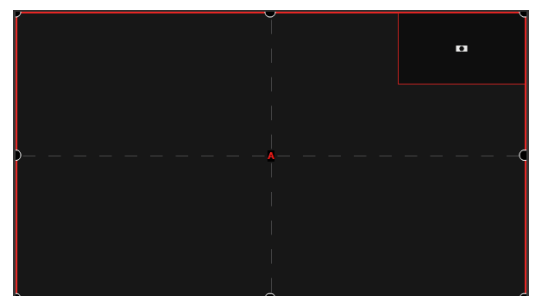

You can edit all the other layer parameters like crop, flip, luma level threshold, etc. Since the Cut & Fill feature belongs to the layer parameters that are included in the preset memory, these settings can be different from one preset to another. For example, using a static frame as Cut content and playing with the thresholds will allow you to create dynamic transition effects.

#### 7.4.4 Layer selection and native background

In the **EDIT** and **LIVE** menus, you can use the layer letter icons (N, A, B, C, ...) to quickly select layers. If you select the native background layer (letter **N**), the **Native Bkg** menu opens up.

In this menu, you can choose the **Native Set** (native background set) to use for the current preset, and adjust certain parameters like the color, transparency and transition type:

- The background color: If you chose color into your set, the color settings will be the affected color. If you chose input or frame, the color will be still here, but under your input/frame. The only way to see it is to have a smaller image/frame than the output resolution.
- The transparency of the native background layer
- The transition type (cut or fade to color) and the timing of this transition.

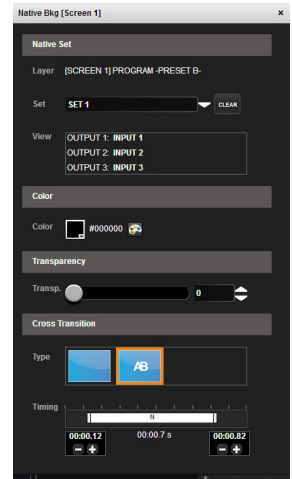

#### NOTES:

- 1/ You can't define your native background **SET** into this section, you can only load it. If you want to modify your set, you have to go to the **SETUP > PRECONFIGURATION > NATIVE BACKGROUND**. Note that before an input can be configured as a native background set, the option «native» on **SETUP > PRECONFIGURATION > INPUTS** must be selected.
- 2/ The choice of native background set is recorded to a preset (Preview or Program), in that way you can do crossfade transition between 2 sets of native background, simply load set 1 into the Program and then load set 2 into your Preview.

#### Layer Layout

The layer layout gives you access to predefined preset patterns with 6, 5, 4, 3, 2 or 1 PIP already sized and placed into the output. It can help you to quickly set up 3 PIPs side by side for example.

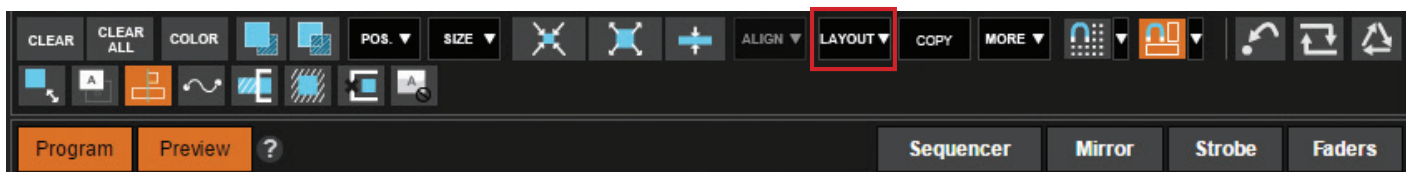

Two other options are available below:

- **Clear other layers:** layers already displayed and not included into the chosen layout will be cleared
- **Fade out other layers:** layers already displayed and not included into the chosen layout will be faded out during the transition. They are still present on the preset but with a 100% transparency.

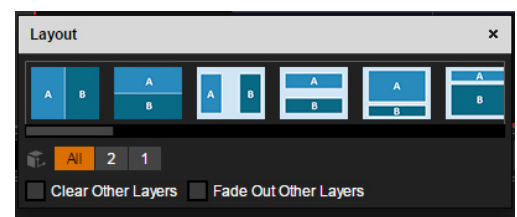

After having selected the layout, the changes are applied on the Preview current. The size and position of all layers have changed. Of course you can still manage the new preset by positioning or resizing each layer using the anchorpoints around it.

Please note that on the **Ascender 48 - 4K - PL** (Ref. ASC4806-4K-PL), perspective layouts are available. *Please refer to the chapter 7.6 How to operate Perspective Layers on the Ascender 48 - 4K - PL for more details.*

## Layer position

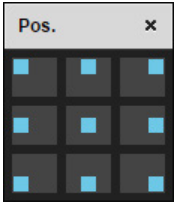
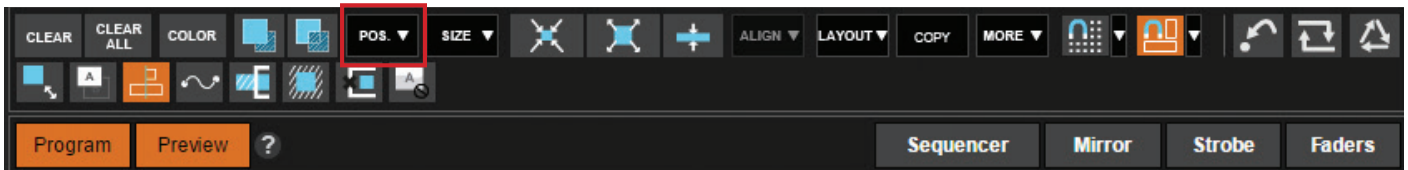

A layer position shortcut is also available. After selecting a layer, click on the Pos. button to have quick access to a predefined layer position. Choose the new position. The change is applied straight away on your preset.

## Layer size

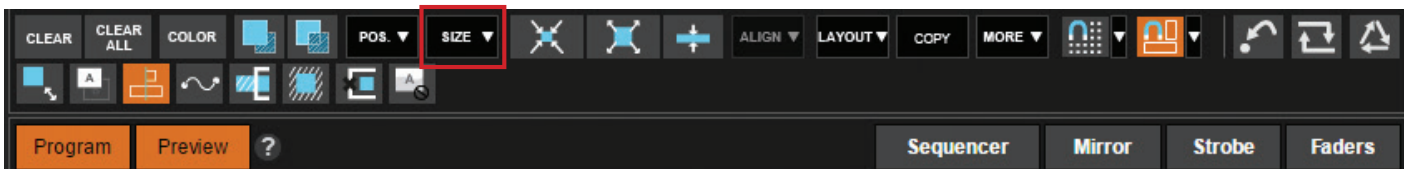



















You can choose between several aspect ratio. Once selected, the new aspect ratio is applied on the selected layer, keeping the horizontal size of the layer.



\*A confirmation will be asked to take into account the operation, the icon has to be clicked two times.

### Other layer adjustments:

-  - **CLEAR BUTTON:** This button allows you to clear the selected layer from your preset
-  - **CLEAR ALL BUTTON:** Clicking this button removes all layers' inputs\*
-  - **RAISE BUTTON:** Clicking this button increases the Z level (depth) of your layer. The current layer will be swapped with the layer above it.
-  - **LOWER BUTTON:** Clicking this button decreases the Z level (depth) of your layer. The current layer will be swapped with the layer below it
-  - **ALIGN BUTTON:** You need first to select at least 2 layers, then you can align them horizontally or vertically
-  - **CONTENT SIZE:** Sets layer size to its content size
-  - **SCREEN SIZE:** Sets layer size to screen size
-  - **COPY BUTTON:** Copies the selected layer into another chosen layer
-  - **KEEP ASPECT RATIO BUTTON:** Enabling this feature keeps the layer aspect ratio during resizing.
-  - **WIREFRAME MODE:** Allows to enable/disable the layer content on your Web RCS
-  - **TRAP LAYERS ON SCREEN:** Disables the possibility to put a layer out of the screen
-  - **SHOW LAYER OUT OF SCREEN:** Enables the view of layers out of the screen
-  - **NO LAYER POS/SIZE CONSTRAINTS:** Disables size constraints (two times the screen size) and position constraint (one layer border has to be on the screen, at least one border in common)
-  - **TOGGLE UNUSED LAYERS VISIBILITY:** All empty layers will not be displayed into the Web RCS
-  - **RELOAD PROGRAM:** Copies the Program screen into the Preview screen with a Cut\*
-  - **TOGGLE PRESET:** Swaps the preset between the Program screen and the Preview screen\*
-  - **STEP BACK:** Return to the configuration you had before the last **TAKE**\*.
-  - **MORE BUTTON:** Background Cut feature is found here
-  - **SHOW FLYING CURVE:** enable/disable the display of the Bezier two points' flying curve on the screen.

The Background Cut is a feature developed by Analog Way engineers which allows you to perform an amazing effect based on crop feature.

The Background Cut calculates automatically, depending on your layers sizes/positions, the specific layer crop, in order to create a full screen image.

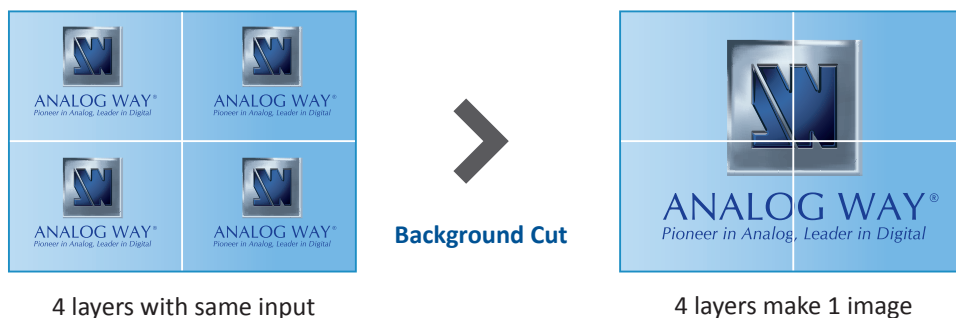

Then fill all layers with the same inputs.

**NOTE:** Be sure your input is set up as FULL SCREEN mode under ASPECT menu.



Activating the Background Cut feature calculates and applies the best crop automatically on all your layers in order to create one full screen image composed of 4 layers.

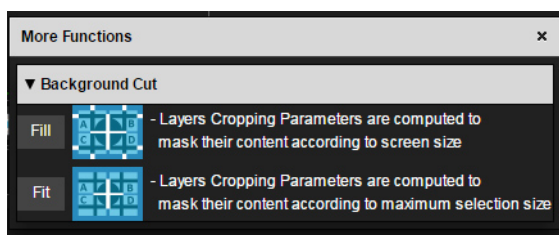

Click on **MORE**, then use the **FILL** feature:

Using **TAKE** you can send your configuration to the Program output to see the result.

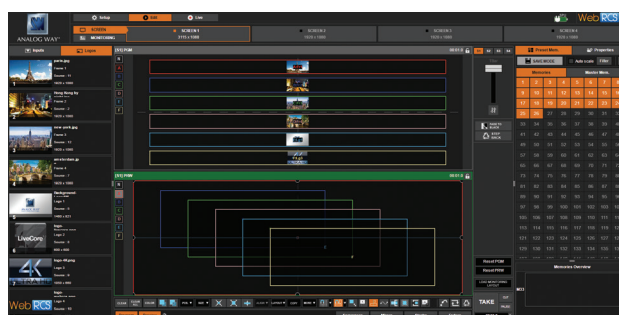
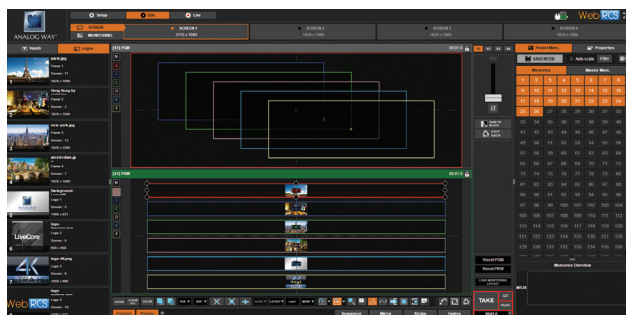

To go deeper with this effect you can try it with different preset layout:

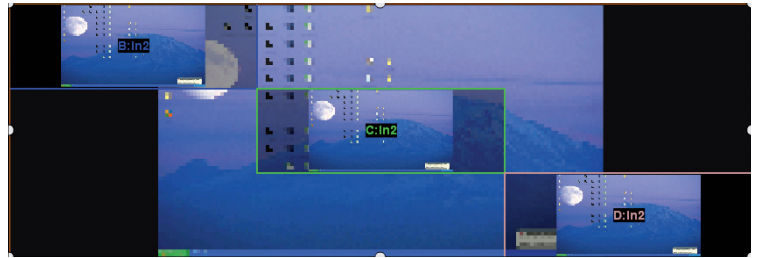
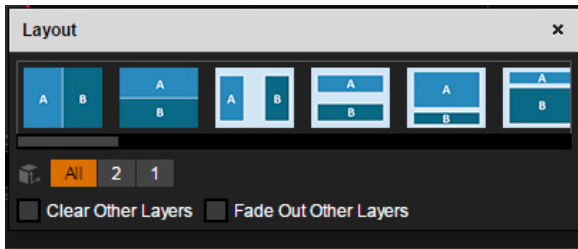

**NOTE:** Don't forget to press the FILL button after changing your layout in order to calculate the new crop according to the new layer positions

If you want, for any reason, to reset the background cut feature, simply reset your layer

Or reset manually each layer crop by using:

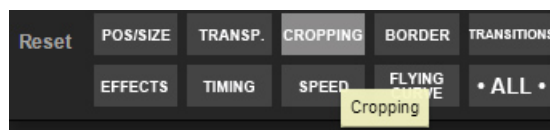

#### - SNAP TO GRID:

The snap to grid feature assists to position and size the selected layer by snapping to points on a custom grid within on your Web RCS. You can choose the size of this grid to make the grid finer or courser. You can also choose to show or hide the grid dots without affecting the magnet effect.

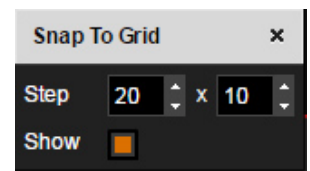

Enable the Snap to Grid feature by clicking on the Snap to Grid button to enable the grid magnet.

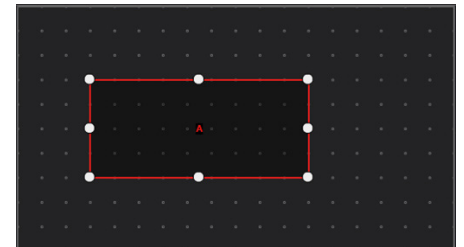

#### - SNAP TO LAYER:

Similar to Snap to Grid, here your layer size and layer position are attracted by the other layer and screen boundaries. You can choose to set the magnet to layer Edge, layer center, screen edge or screen center. Choosing the 4 choices gives you more magnet point and help you to set up your layer with more accuracy.

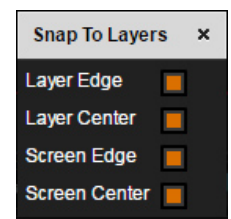

Like the snap to grid, click on Snap to Layer button to enable/disable the snap to layer feature.

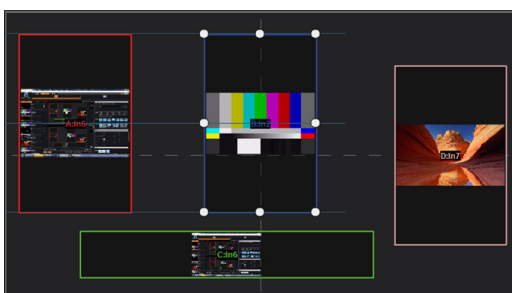

#### - SHOW ALIGNMENT:

This feature shows alignment lines when the layer position or size becomes aligned with a layer edge or center. For example, a line will appear when the selected layer is vertically centered with another. Clicking on this button toggles visibility of these alignment lines.



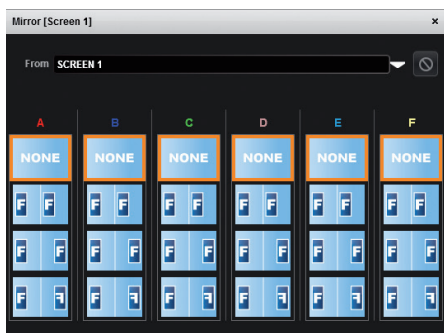

### - MIRROR BUTTON: **Mirror**

The mirror button allows you to define for each layer the way it will be mirrored from one Screen to another Screen. You can choose to mirror the layer, flip the position, or flip the position and the data from another screen. To access this feature, you first need to be in a hybrid configuration with 2, 3 or 4 Programs (*see chapter: 7.3.4 Screens*), then into the Setup assistant, you need to activate the “screen mirroring”.

**Note:** the mirroring feature can only be used from one screen to another. It cannot be used to mirror the same content on the same screen.

### - STROBE BUTTON: **Strobe**

Using the strobe settings, will allow you to play with the refresh rate of an input. One cursor per layer is available.

Each cursor represents one layer. Increasing the cursor level, you will perform a strobing effect on the specified layer. At the bottom of each cursor, a stop button allows you to stop immediately the effect.

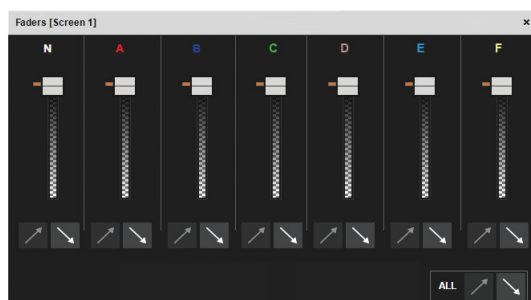
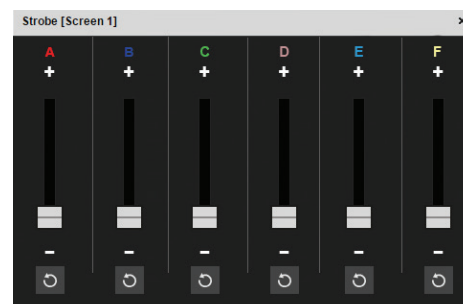

### - FADERS BUTTON: **Faders**

The Faders toolbar allows you to configure a semi-permanent transparency override to specific layers. This transparency will be in effect regardless of the configured layer transparency, until restored in the Faders toolbar.

Under each layer transparency cursor you have an automatic increase/decrease transparency button which fades in or out your layer to the selected transparency.



## 7.4.5 Preset load and save management



### Save a preset

Once your layers are set up, you can save your current screen configuration in one of the 144 preset memory slots available. Click on **SAVE MODE** at the top of the **Preset Mem.** toolbar and then click on a preset slot number to save the current screen configuration as a preset. If you accidentally attempt to save over an existing preset, a warning and confirmation message will pop-up:

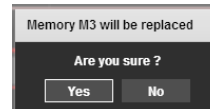

You can also double-click on **SAVE MODE** to lock save mode when saving presets. The **SAVE MODE** button will blink while the save mode is enabled. Make sure to de-select **SAVE MODE** to unlock save mode when finished saving.

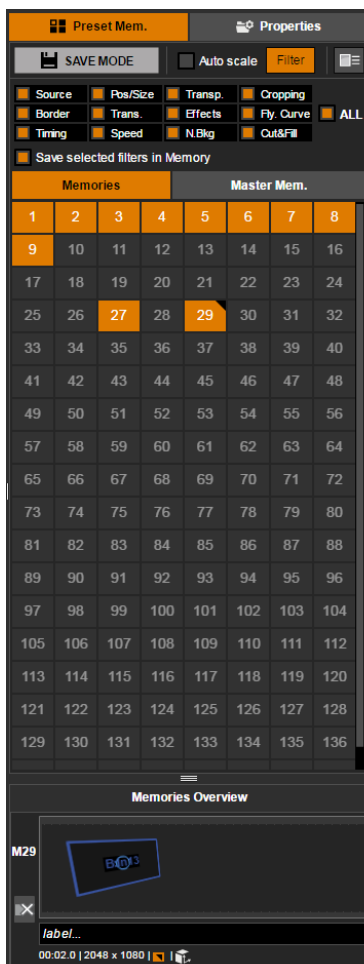

### Load a preset

Simply click on a preset slot number when save mode is disabled to load the preset.

You can use the **Memories Overview** box at the bottom of the **Preset Mem.** toolbar to review the content of your presets:

- Hover over a preset to have an overview of the preset.
- SHIFT+click on a preset to label the preset.
- SHIFT+click on a preset and click twice on the **Reset** button to delete the preset.





### Use filters

You can use the Filter feature to load a subset of the preset information, like the border property of layers only, or the size and position of layers but not their sources, or the native background and the transparency but not the flying curve effect, etc.

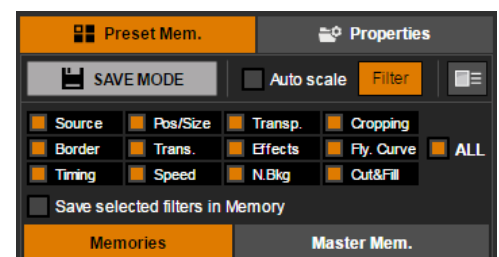
To use the Filter feature, click on the **Filter** button at the top right corner of the **Preset Mem.** toolbar and select the filter(s) to apply when the preset is loaded. Then click on the preset to load the preset with the selected filters applied.



The **Save selected filters in Memory** box allows you to save a preset with the selected filters already applied (i.e. no need to select the filters to apply to load for this preset: the filters will be automatically applied when the preset is loaded).

The «truncated»  preset memory icon allows you to quickly review which presets have filters already applied. To check which filters, SHIFT+click on the preset and hover over the filters information icon: 

- (x) **Filter\_name**: the filter has been saved and will be automatically applied when the preset is loaded.
- ( ) **Filter**: the filter has not been saved and cannot be applied when the preset is loaded.

At load, you can further apply new filters: both currently selected filters and saved filters (if any) will be applied when the preset is loaded. *See also 7.5 Live: FILTER FEATURE*

### Reset button

You can reset the program or preview using the reset button. Using that, all layer attributes will be reset. All layers will be reset to the default layout. These tools are protected by a pop-up confirmation against accidental clicking; a second click has to be made for the reset to occur.

If the “Hide unused layers” button is enabled and no more layers are available, you still have access to the layer selection on the right, thanks to the A, B, C, D, E and F buttons.

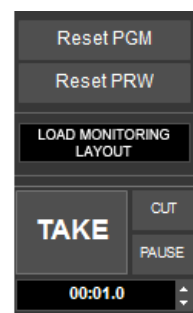

Please note that MASTER MEMORIES will be detailed in the LIVE topic, see [chapter 7.5 Live](#).

## 7.4.6 Logos and Frames management

On the left side toolbar, you have access to your 8 still slots. Those slots can be filled by logos and frames. To load the slots, go into the SETUP section and click on Logos menu. You can then assign an previously acquired image from the Logo Library to each slot.

Or on the EDIT or LIVE pages section, under the logos tab, click on the Setup button next to each slot to access to the slot configuration. Choose the logo from your library to fill the slot. Other logos configurations are available. (*See chapter: 7.3.12 Logo management*). You also have the possibility to display the frame and logo in full screen on the monitoring, clicking this icon:



## 7.4.7 Inputs management



On the left ribbon, inputs can be taken and drop on the layer. The inputs have been set on the Setup part but a shortcut enables settings modification in the Edit section.

The active plug is chosen on the Setup section; but it can also be modified in the Edit and Live sections.

Then an input freeze shortcut is available as well as a shortcut to display the input in full screen on the monitoring output.

**Warning:** if you change the active plug while the input is displayed in a layer, you will change the source displayed. You may see some artifact during switching.

## 7.4.8 Monitoring management

The **Edit/Live > Monitoring** tab allows you to configure the operator’s monitor layout. The layout can be in mosaic/multiviewer mode with several windows/widgets, or in fullscreen mode where only one window (widget) is displayed.

12 windows/widgets are available on all **LiveCore™** Monitoring outputs, with the exception of the **NeXtage 08 - 4K** and **NeXtage 16 - 4K**, which have only 8.

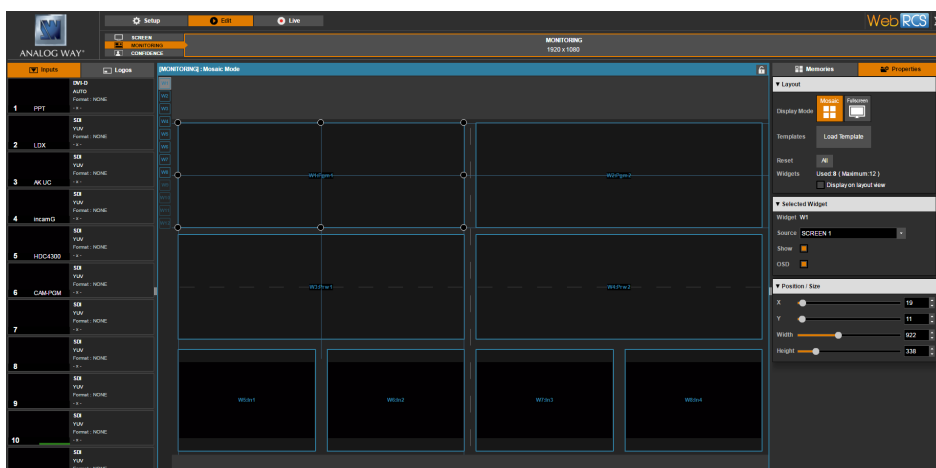

## Properties

Click on the **Properties** left side toolbar and then on **Templates > Load Template** to set the monitoring layout. The **Display on layout view** option enables a feedback of the number of resources used to display one widget. Displaying a multi-stream source like a blended screen or dual-link input will limit the number of elements that can be displayed.

Select a widget and go to the **Selected widget** section to change the source to display in the widget.

Under the **Position/Size** section you can adjust the size and position of each window (widget), no overlap is allowed.

You can also use the monitoring edition tools at the bottom of the monitoring screen to arrange, resize and position your widgets.

## Memories

The **Memories** toolbar allows you to save up to 8 monitoring layout memories.

To save a monitoring layout, enable **SAVE MODE** and click on a monitoring memory slot number.

To load a monitoring memory, click once on the associated monitoring memory slot number.

Like for preset memories, you can also use the **Memories Overview** box at the bottom of the **Memories** toolbar to review the content of your monitoring memories:

- Hover over a monitoring memory to have an overview of the memory.
- SHIFT+click on a monitoring memory to label the memory.
- SHIFT+click on a monitoring memory and click twice on the **Reset** button to delete the memory.

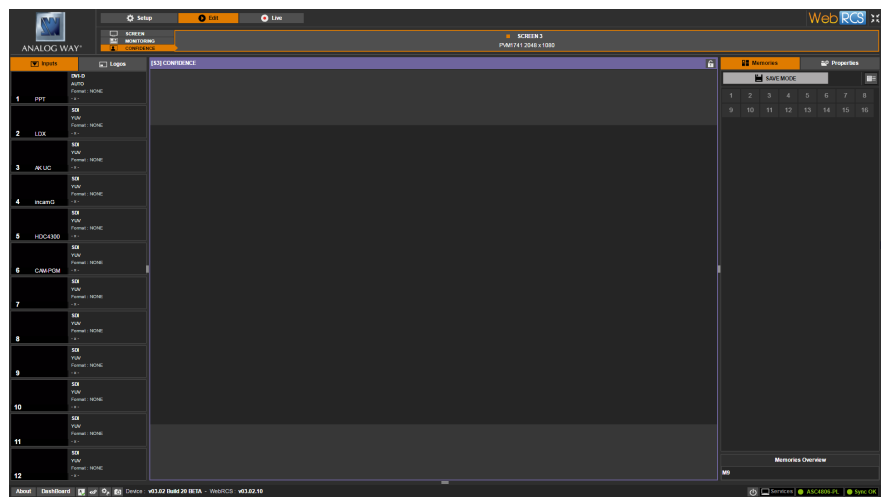

## 7.4.9 Confidence management

The **Edit/Live > Confidence** tab allows you to configure your confidence screen layouts. Like for Monitoring layouts, the confidence layout can be in mosaic/multiviewer mode with several windows/widgets, or in fullscreen mode where only one window (widget) is displayed.

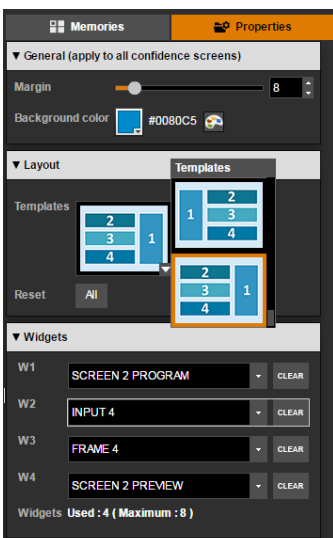

### Properties

Click on the **Properties** left side toolbar and then on **Layout > Templates** to set the confidence screen layout. You can choose one amongst 14 different predefined layouts ranging from 1 to 4 windows (widgets).



Under the **Widget** section you can choose the **Input**, **Frame** or **Logo** to display in the widget.

### Memories

The **Memories** toolbar allows you to save up to 16 confidence layout memories.

To save a confidence layout, enable **SAVE MODE** and click on a confidence memory slot number.

To load a confidence memory, click once on the associated confidence memory

slot number.

Like for preset and monitoring memories, you can also use the **Memories Overview** box at the bottom of the **Memories** toolbar to review the content of your confidence memories:

- Hover over a confidence memory to have an overview of the memory.
- SHIFT+click on a confidence memory to label the memory.
- SHIFT+click on a confidence memory and click twice on the **Reset** button to delete the memory.

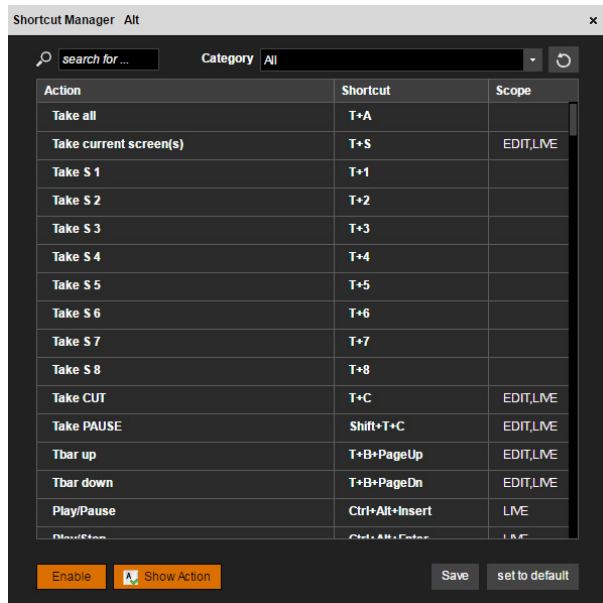

**Shortcuts on the Web RCS:** in order to simplify the layer management, a list of keyboard shortcuts is available, by clicking on the icon. 

Shortcuts can also be customized to adapt to the operator's preferences. To assign a new keyboard combination to a particular shortcut, hover over the shortcut you wish to edit, and click on the edit button to display the Edit Shortcut pop up:

While the Edit Shortcut popup is being displayed, press your new keyboard combination for this shortcut and then click on "valid" to validate the new shortcut. You will receive a warning if the desired shortcut is already in use.

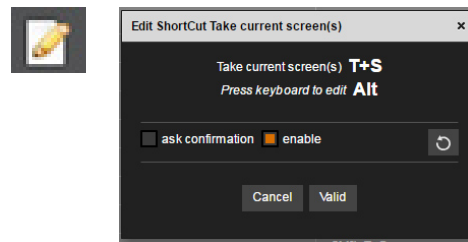

You can at any time restore the default configuration of this shortcut by clicking on the reset button. 

The checkbox "ASK CONFIRMATION" will display a yes/no confirmation popup each time you trigger this shortcut.

In the same way, a **QUICK SETUP** panel is available, clicking this icon 

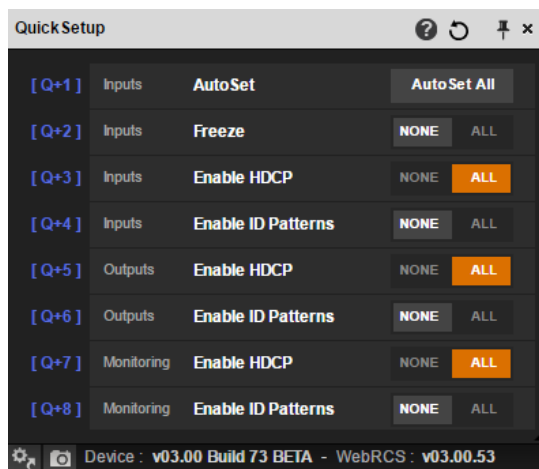

The **Quick Setup** provides a fast access to the input autose, global input and output HDCP management, global input and output ID patterns.

## 7.5 Live

Default settings of the Live mode enables to display all the screens and enables the **TAKE** button to affect all Screens.

On the right, you will find all your memorized presets under the tab called “**MEMORIES**”. A simple drag and drop on the screen will load your preset into the screen (Program or Preview).

**LABEL:** don't forget that you can assign a name to your memories using the **SHIFT + Click** operation.



If you want to change an input into your preset into the live mode, simply use the left source ribbon and drag and drop your input into a layer.

Under each preset you have its size and its duration.

Remember that a preset saved into a screen with a 1024x768 resolution, will normally keep its size into a screen of higher resolution. If you want the preset to be adapted to the target screen size, use the **AUTOSCALE\*** button. With this function enabled, all preset layer attributes will be automatically stretched to fill the target screen.

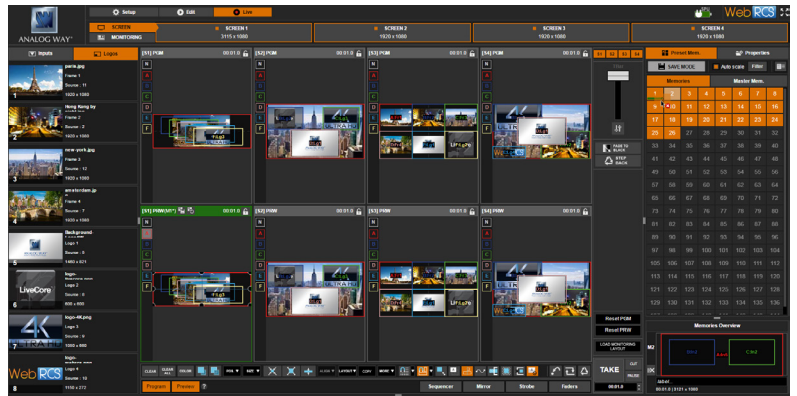

*\* Please refer to the **chapter 7.6.2 Memories and AUTOSCALE with Perspective Layers** to use the **AUTOSCALE with Perspective Layers**.*

### FILTER FEATURE:

You can use the **Filter** feature to load a subset of the preset memory information:

- Click on the **Filter** button to enable the Filter feature.
- Select the filter(s) (information or properties) that you want to load with the preset.
- TIP:** use **ALL** to select or unselect all properties at once.
- Click on a preset to load the preset with the selected filters applied.

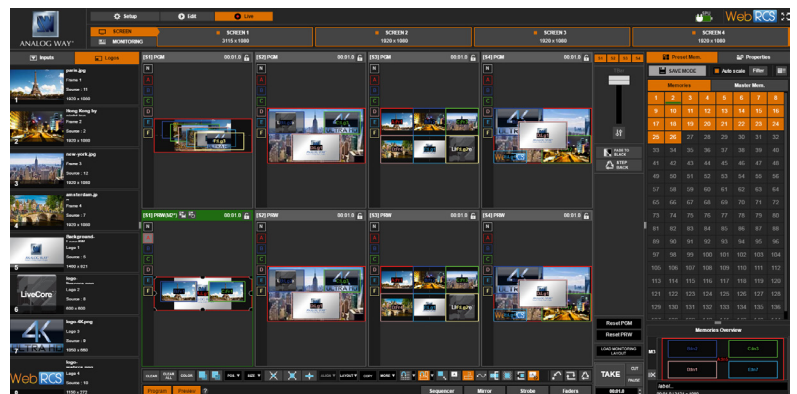

Please note that loading a preset with the Filter option enabled will load the preset with the currently selected filters **and** the filters previously saved with the preset (if any) applied. *See also 7.4.5 Preset load and save management.*

Once your preset is ready to send, use the **T-bar**, or the **TAKE** button.

When you use several screens, you have the possibility to load a preset in one of the screens. You can **TAKE** the Program on one screen separately, or all at the same time, by modifying the current screen selections, found at the top of the **TAKE/T-BAR** section:



A **FADE TO BLACK** and a **STEP BACK** buttons are also available. The **FADE TO BLACK** transforms your Program in a black screen using a fade effect on all your layers. The **FADE TO BLACK** feature remains enabled until the **FADE TO BLACK** button is pressed again. **STEP BACK** recalls your previous preset to preview.

### MASTER MEMORIES:

A **Master Memory (MM)** is a macro of **memories (M)**: it can load several memories on several screens at once (one for each screen), and it can also load confidence memories on confidence screens.

This way, you can use Master Memories to simultaneously load content on several screens, including Confidence.

### CREATING MASTER MEMORIES:

Before creating a MM, it is recommended to create the memories for your individual screens first, including your confidence memories. Then, to create the **MM**, go to the **Master Memories** toolbar, click on the **SAVE** button to enable save mode, and select a Master Memory slot to open the **Save to MM** dialog box. The **Save to MM** dialog box will help you create the preset to be saved:

Select **From Saved Preset Memories** to create the MM from already saved memories. Then select which memories should be recalled on each screen by either drag and dropping a memory from the **Memories** toolbar to the screen, or by using the preset memories drop-down menu. Confidence screens are highlighted in purple and you can use the drop-down menu to select the confidence memory. Once you are done, click on the Save button (located at the bottom of the **Save to MM** dialog box) to create the MM.

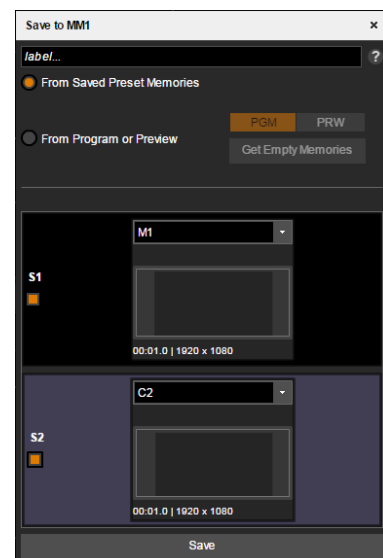

**Note:** You can enable and disable screens from the Master Memory by selecting/unselecting the screens: if a screen is disabled, then the MM will not affect the screen when loaded.

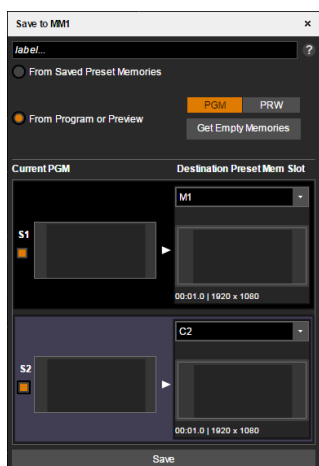

If you do not have any saved preset Memories, you can select the option **From Program or Preview** to create a Master Memory based on your current program or preview:

With the **From Program or Preview** option enabled, select PGM to save from the current program or select PRW to save from the current preview. The unit will then save each current screen configuration (program or preview) into a valid Memory, and build the Master Memory from those Memories. To let the unit locate unused Memories, click on the Get Empty Memories button. Otherwise, you can manually select the destination Memory for each screen using the drop-down menus.

**BE CAREFUL NOT TO SAVE INTO AN EXISTING MEMORY, ELSE IT WILL BE OVERWRITTEN.**

Once you have established the preset Memories used by the Master Memory, you can click the **Save** button (located at the bottom of the **Save to MM** dialog box) to create the Master Memory.

## LOADING MASTER MEMORIES:

The Master Memory is now saved, and can be recalled by the **LOAD MASTER MEMORY** button or simply by drag and drop the master memory to the screen windows. Remember that like the single-screen memories, one click on a Master Memory will load it to the location of the currently selected layer. If no layer is selected, the single click method of loading will not work.

To rename or delete a Master Memory, hold the Shift key and click on the Master Memory.

**RESET ALL PROGRAMS** and **ALL PREVIEWS** buttons enable to reset all programs and all previews from all screens.

## LOAD MONITORING LAYOUT:

During your live session, you may want to change the layout of the monitoring output. You can load any user layout you previously saved from the Monitoring configuration area.

## SEQUENCER:

The Sequencer feature was totally rethought for version 02.00. This version brings many improvements to the sequencer, including sequences of variable length, variable action between sequencer events, and sequencer control of memories and master memory presets, but also actions like loading a library frame to the frame slot.

The sequencer is found at the bottom of the Edit and Live pages. Click on the **SEQUENCER** button to expand the sequencer toolbar.

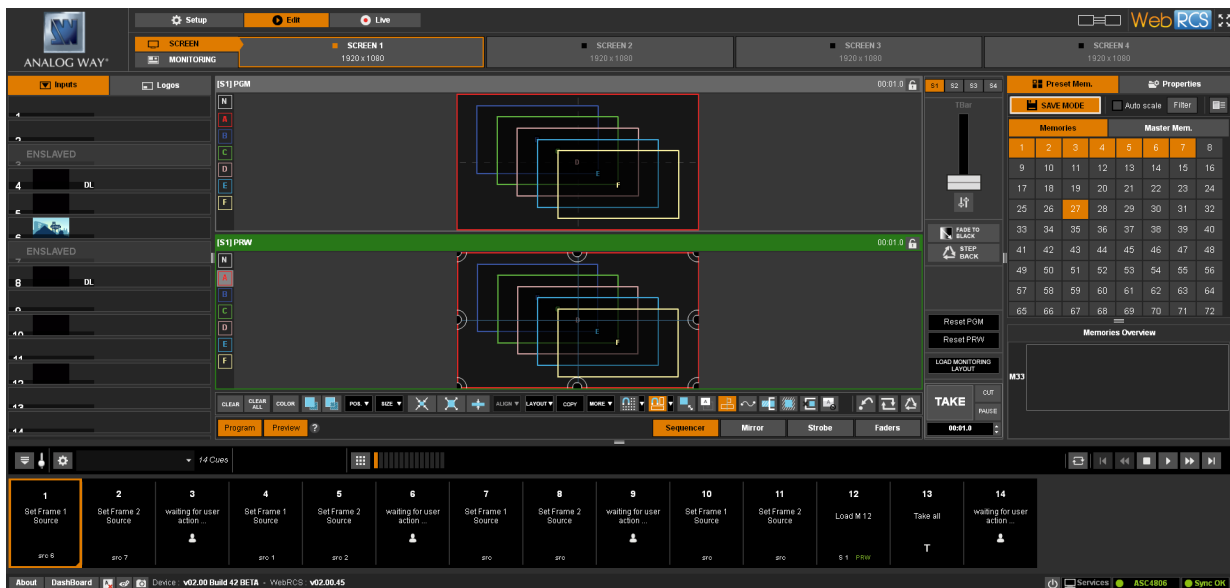

A default sequence will be displayed. To open the Sequence Editor, click on the configuration gear icon on the left side of the sequencer toolbar.

The Sequence Editor shows the current sequence in the middle, a list of the saved user sequences on the right, and a list of either pre-configured Template sequences, or a list of possible Cues to add to your sequence.

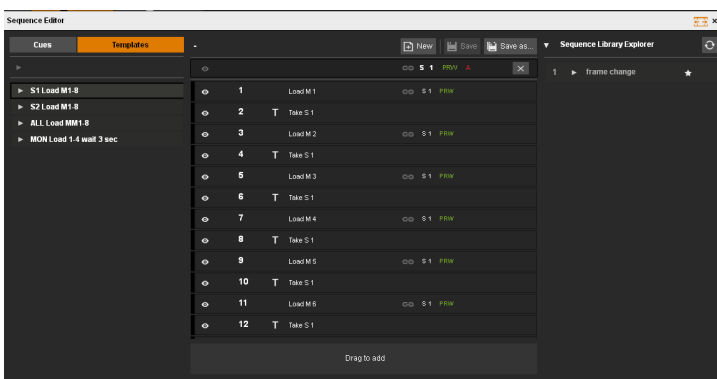

To load a sequence from either the preconfigured templates or the user created Sequence Library, double click it or drag it to the Sequence list. Only one sequence can be loaded at a time.

To add a new cue to the sequence, open the Cues toolbar and select any cue from the list. The pos-

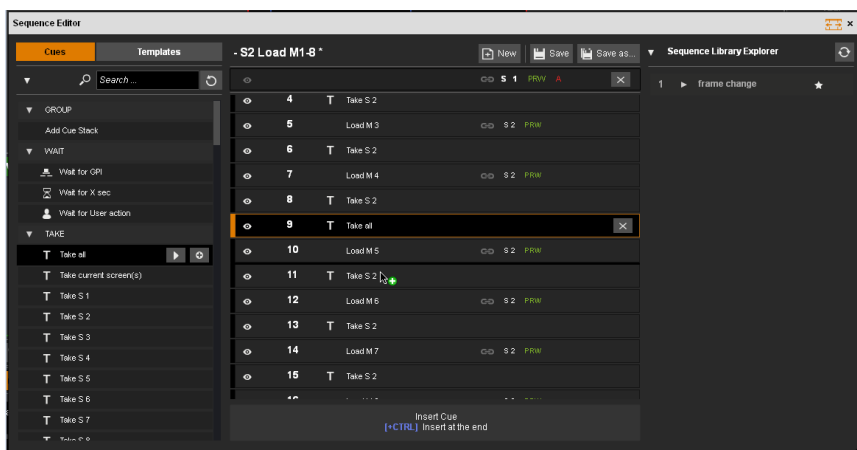

at the bottom, or click on the button that appears when you hover over a potential cue action. For example, add the Select Input 1 to selected layer(s) to your cue stack by finding in the list of cue actions, and dragging it to the sequence list.

Shortcuts to load Memories/Master Memories #1 to #8 are pre-existing. To load other memories (over #8), just drag and drop them from the right side toolbar to the cue list.

Once the cue action has been added to the sequence list, you may need to edit its properties or display name. Double-click on the cue action attributes to edit them, and double click on the the description of the cue action to change its display name. For example, edit the Select Input 1 to selected layer(s) cue by clicking

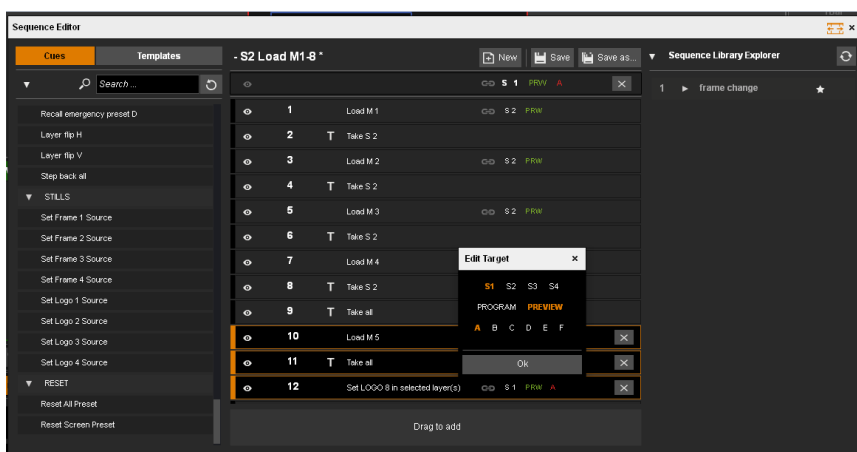

sible cues are grouped by function and include items like “Wait for X Second” or “TAKE” or “load preset “ or “Set Frame slot 1 source” or “Set layer fullscreen” etc. Use the search bar at the top to help find a specific cue action.

To add a cue action to the sequence, drag it into the sequence where you’d like it to appear. To add it to the end of the sequence, drag it to the target area

on the text that says “S1 PRV A”, which indicates this cue will affect Screen 1 Layer A Preview. A small popup window will appear offering you to choose a new target for this cue action.

To delete a cue from the sequence list, click on the “X” next to the cue.

Once you have created a sequence list, you can save it using the “SAVE” button at the top of the sequence list area.

To play your sequence, use the sequence navigation controls on the

right side of the sequence toolbar.

You can set the sequence to loop, start from first, rewind one step, stop, play/pause, fast forward one step,



or go to the end.

The Sequencer can also be used in Keypad mode, which allows you to easily trigger individual sequencer events out of order. For example, you might create a list of important presets to quickly choose from, or create shortcuts to update the frame slots with specific library frames for faster setup.



Please note that the browser should not be downsized, otherwise the browser make the sequence running in slow motion.



## 7.6 How to operate Perspective Layers on the Ascender 48 - 4K - PL & Ascender 32 - 4K - PL

The Perspective Layers feature enables the user to modify layers within three axes and act on the rotation of the layers.

The perspective option has to be enabled per screen, on the **SETUP > PRECONFIG > SCREEN**.

When enabling the Perspective Layers, you have the choice to enable the Z mixing or not.

The perspective option add new properties such as three axes layer control X for the horizontal axe, Y for the vertical axe and Z, introduced by the perspective option for the depth axe.

Normally each layer has a predefined position depending on the other: the layer A is in the background, then the layer B ahead, then the layer C and so on.

If the Z mixing option isn't enabled, when a layer's depth is lower than other layers, the order of layers will be kept in the above order. When enabled, the order of the layers will be depth dependent.

### Please note:

- That if the Z mixing is enabled, the live input for native background must be at the output resolution. For 4K 30Hz native input can be displayed on the native background only if the working rate of the device is 30Hz.
- That perspective layer do not support Dual-Link or 4K input signals as well as dual frames.

### 7.6.1 Edit page

Once in the EDIT page, you have a feedback of the perspective option at the right of the screen, knowing that a perspective layer require double resources, instead of 6, you will have three layers available.

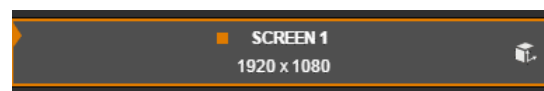

#### - Position and size

When enabled, the perspective options provide the possibility to act on the layer position in three dimensions: as usual the horizontal and vertical position and now also the depth position. The related marks on the properties are X, Y and Z.

Moreover, a rotation of the layer can be applied. The rotation can be related to the axe X, Y or Z. The related marks on the properties are RotX, RotY and RotZ. Shortcuts are available on the layer itself, by pushing the marks X, Y and Z.

These rotations are related to a reference point called anchor point. By default, this point is the middle of the layer, but it can be modified by pushing.

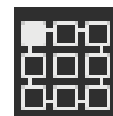

Please note that the anchor point is saved on the preset, it is not recommended to change this point into the same sequence as it also modifies the position of the PIP, creating unexpected moves.

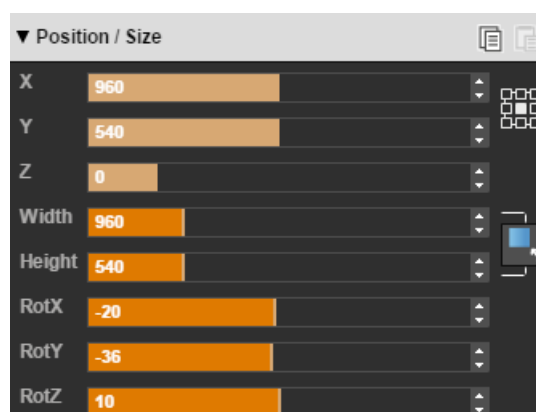
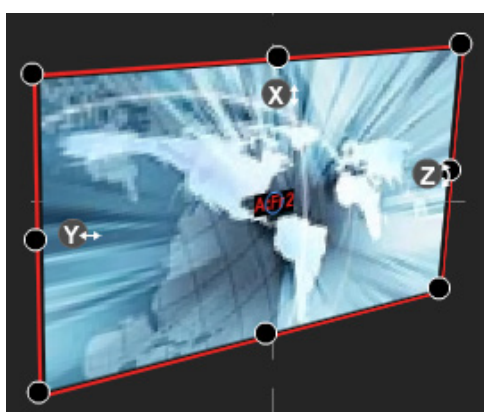

**- Flying curve**

The flying curve is the customizable curve for flying PIPs. When in Perspective Layers mode, the two points of the curve still can be modified and the depth of the PIP during the flying is also customizable. The drawer assistant enables the graphic modification of axes X and Y, while the Z axis has to be set on digital controls.

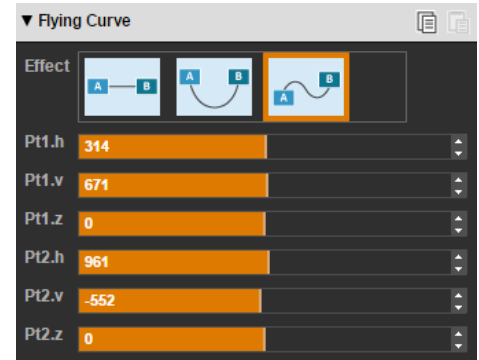
**- Perspective layout**

In order to shorten the setup time, predefined perspective layouts are available clicking on the layout shortcut.

**7.6.2 Memories and AUTOSCALE with Perspective Layers**

When a memory is saved, you can recall it to another screen. Please note that with Perspective Layers, recalling a preset to another resolution's screen may modify the layout result.

## 8. OPERATING THROUGH THE FRONT PANEL

### 8.1 Front panel

#### 8.1.1 Front panel update

Simply download the update file on your computer from the website. Then take the file **LivecoreUpdate\_xx\_xx\_xx.awp** and copy it into the root directory of your USB key.

When the unit is running and the home menu is displayed, simply plug the USB key, the update is automatically detected. A warning message is displayed on the front panel screen of the unit. Please press YES or NO with the help of the contextual button in order to launch or not the update. Unplug the USB when it starts to install the version.

In the case of booting problem, the USB key can be introduced 1 minute after starting up the device, to force the unit to update. Be sure to remove the USB key before starting the unit.

Here are the update steps. When detected, the LCD front panel screen will display:

Updater Package Detected

Then the unit start to decode the package

Updater Package Decoded

The next step is to unpack the package, when it is finished, you will have the next message:

Updater Package Unpacked

The updater will be launch into the **LiveCore™** unit displaying:

Execute Updater Package

The update is now ready to start and this following screen will be displayed:

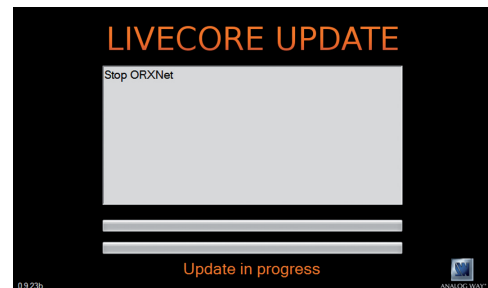

Wait for the update to finish displaying this screen:

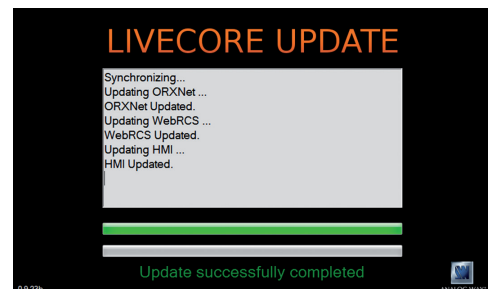

You update is now successfully completed.

If case of message like:

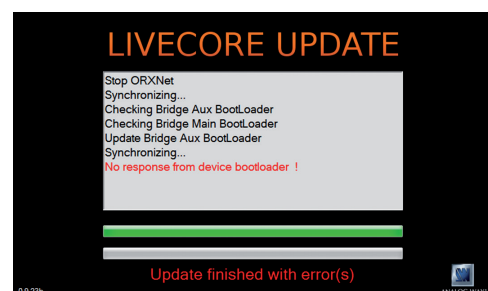

That means the update has failed, please try to update the unit again by restarting the updater. If the unit does not boot, please use the USB updater.

### 8.1.2 LCD screen

A **LiveCore™ unit** offers a LCD screen on the front panel which allows you to always have an overview of your settings. The LCD screen is a 4,3” diagonal size and a 800x480 pixels resolution.

Analog Way developed an ergonomic HMI to help customer to setup the unit with the help of the front panel.

You will find same settings into the front panel menu and into the **Web RCS**. Please refer to the specific setting chapter menu if you need accurate explanation on a setting.

Please take a look at the menu tree if you want to have a clear view of all available menus.

On the LCD you will find all menus around a text area. This text area describes the selected menu. To navigate into menu, simply turn the scroll knob to the chosen directory/menu and press **ENTER** button to enter into the menu or validate the setting. You can use the **EXIT** menu at any time to perform a step back into the menu structure.

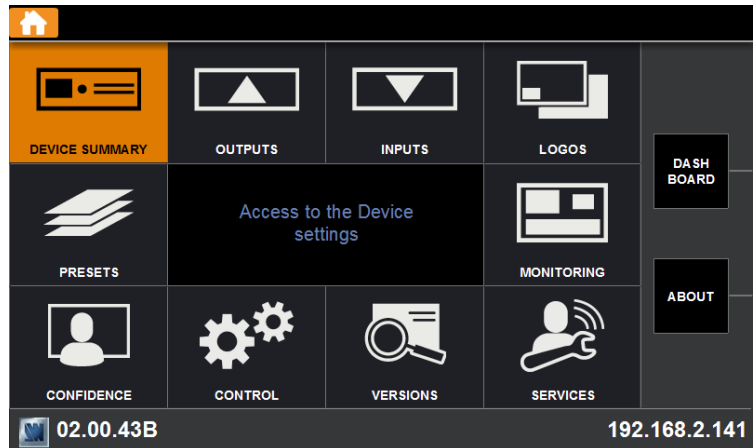

#### CONTEXTUAL BUTTONS:

Four contextual buttons were put in place to help you to overview the state of your unit.

- The top one and the last one contextual buttons allow the customer to quickly navigate into the menu architecture. By clicking on those buttons, the cursor is now on the top menu list, and then using the scroll knob, you can choose to come back directly at the home menu, or choose the directory you want. Then click **ENTER** to validate your choice
- The second one is the dashboard shortcut. Pressing this button, you have access to the dashboard, all main information on your device.
- The third one is the **ABOUT** shortcut. Click on this button to have more information about your Analog Way's **LiveCore™ unit**.
- The fourth button will display a specific Layer's summary window.

On some specific menus, the Contextual buttons have different functions:

- The contextual button 2 and 3 can display the text: Program and Preview. Depending on the modification you will apply, select the **PROGRAM** or the **PREVIEW** contextual button in order to apply your setting on the Program or Preview preset.

### 8.1.3 Front panel buttons

The front panel buttons provide you a full access to your layer/source and preset. *(See the front panel description at chapter: 5.1.2 Front panel)*

First of all select your **SCREEN** number, in order to know on which screen you will do the modification.

Don't forget to always check on which screen you are doing the setup.

Then select the **PROGRAM** or **PREVIEW** buttons, in order to choose on which preset you will work.

We advise you to always play on the Preview preset.

Then you can build your own preset using the **LAYER SELECTION** buttons:

- Press native BKG button then press a source button (1-8) to affect the SET 1-8 into the selected preset (selected screen/selected Program or Preview)
- Press A, B, C, D, E or F to have access to a live layer, into this layer you can affect a source (press the **SOURCE** button 1-12) or affect a frame/logo pressing the **FRAME/LOGO** button and then press the **SOURCE** button 1-8.

Press the **FRAME/LOGO** button before pressing the **SOURCE** button, will act like a shift button, the source 1 to 8 become to frame/logo from 1 to 8.

Pressing the **COLOR** button instead of source 1 to 12 will simply fill your selected layer with a color.

If you want to clear a layer, simply select your layer and then click on **CLEAR** button. It affects no source to your layer. After a take you layer will be close.

### The TAKE button:





The **TAKE** button is the final button to press, this button will copy your Preview preset into your Program preset according to all the settings you adjusted into your Preview preset.

### FEATURES SHORTCUTS:

- **ASPECT IMAGE LAYER:** clicking on this button, after selecting a layer, you layer will be size on a different known aspect ratio in order to quickly find the best layer size.
- **FREEZE:** after selecting a layer then a source, press the **FREEZE** button to perform a freeze on the chosen input. This input stay frozen until you disable the freeze feature.
- **PRESET LOAD/SAVE:** those buttons give you a quick access to the list of 64 preset slots. Clicking on **LOAD/SAVE** will display on the LCD the list of preset, simply select the chosen one to **LOAD** or **SAVE** into this slot.
- **STEP BACK:** press the **STEP BACK** button to recall your previous preset on your Preview preset.
- **STAND-BY:** Push the button once then confirm your choice with the contextual button: YES.

### BUTTON COLOR USAGE:

Using the front panel you can see that each button can have a specific color according to the fact the input is present on Program or not. Please find an array of this color status:

|                        |   |   |
|------------------------|---|---|
| <b>Solid red:</b>      |  | #1 = Source is on the Program output<br>#2 = Freeze enable<br>#3 = Stand-by button<br>#4 = Preset Selection |
| <b>Solid green:</b>    |  | #1 = Source is on Preview<br>#2 = Function available for modification                                       |
| <b>Blinking red:</b>   |  | Layer/source selected or is currently active on the Program output  |
| <b>Blinking green:</b> |  | Layer/source selected or is not currently active on the Program output                                      |
| <b>Solid orange:</b>   |  | Contextual button   |

### FINE TUNING:

**LiveCore™** unit front panel allows you to use the scroll knob button to navigate easily into the menu. Pressing on this specific button will enable/disable the **FINE TUNING** feature.

**This feature increases the sensibility of the button and can be helpful if you want to adjust a specific value in a high band value.**

To set up it correctly, simply turn the knob quickly next to the desired value, then push the button to activate the **FINE TUNING**, and then take your time to adjust accurately the exact value. This can be helpful to adjust an exact pixel size/position or to set up the accurately Soft Edge.

## 8.2 Menu tree

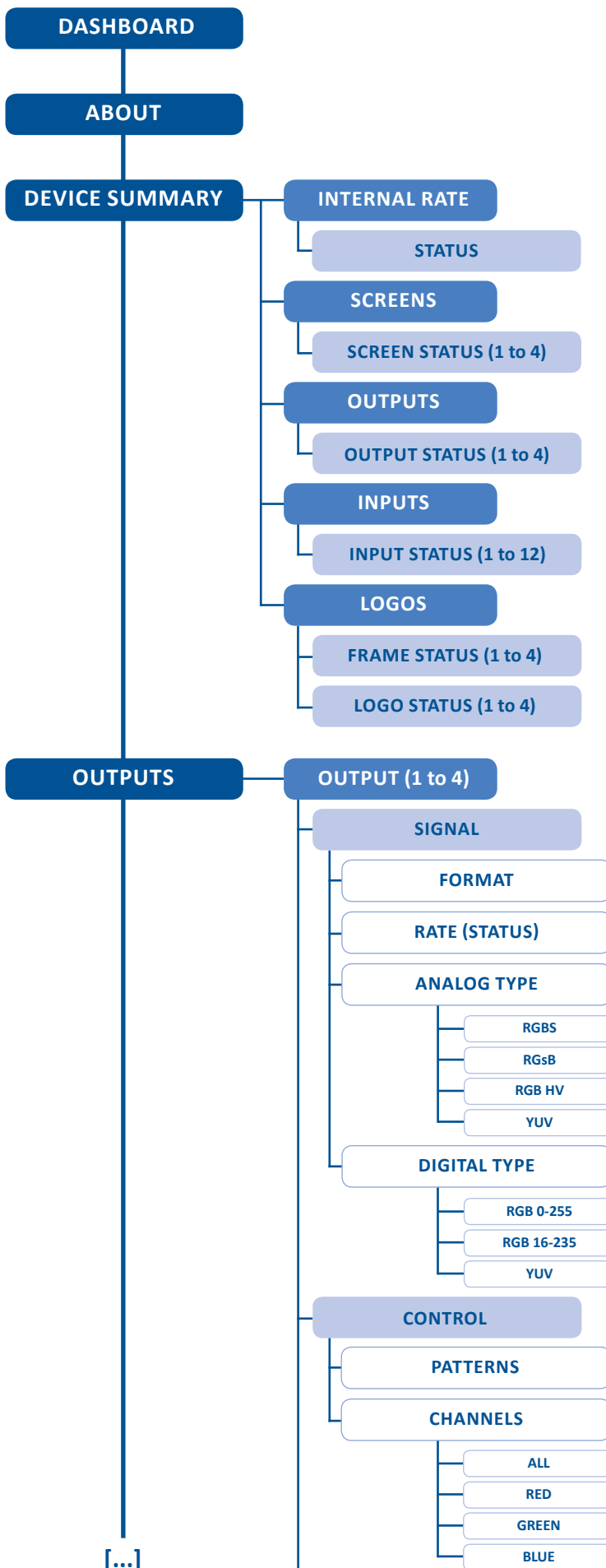

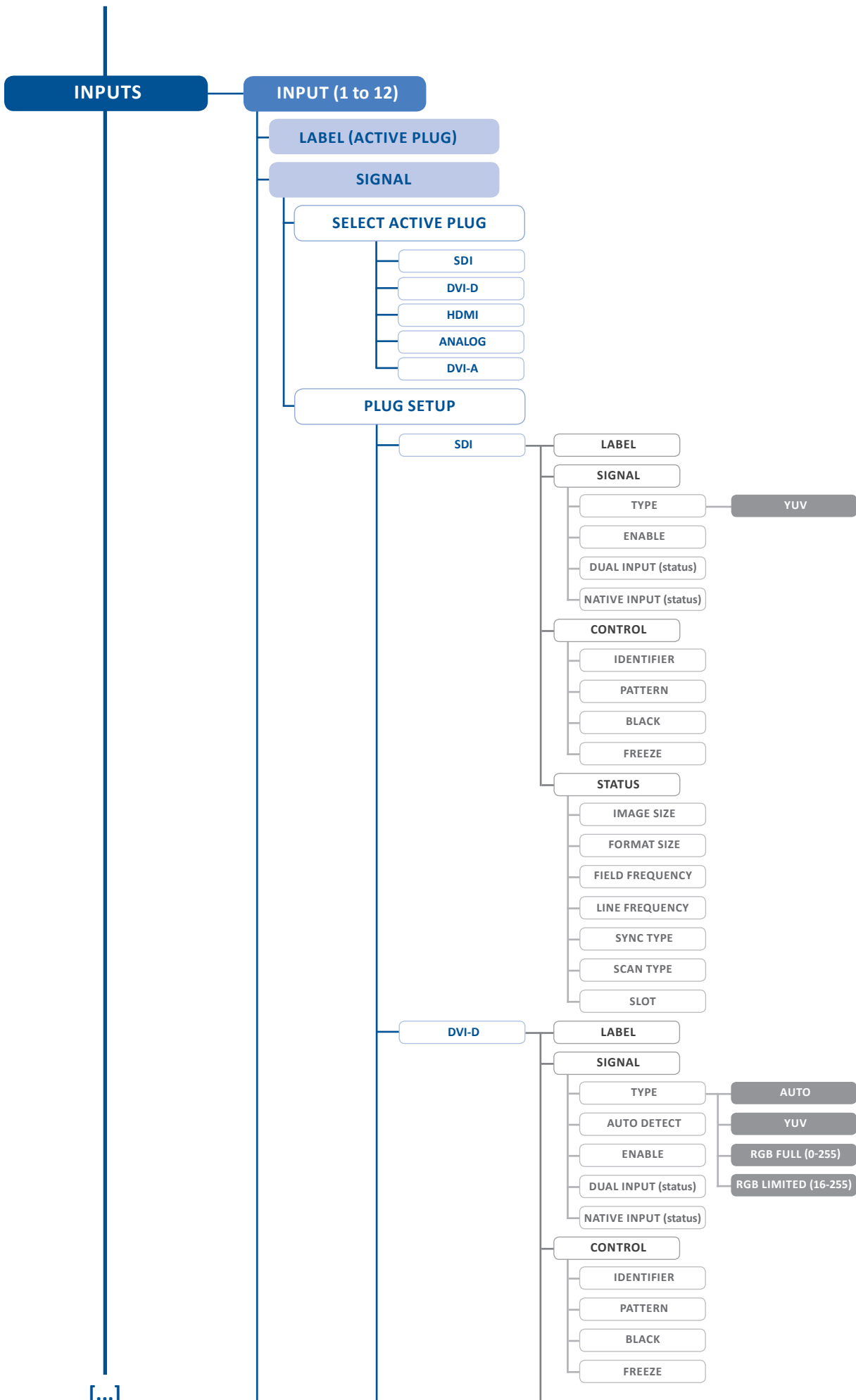

[...]

[...]

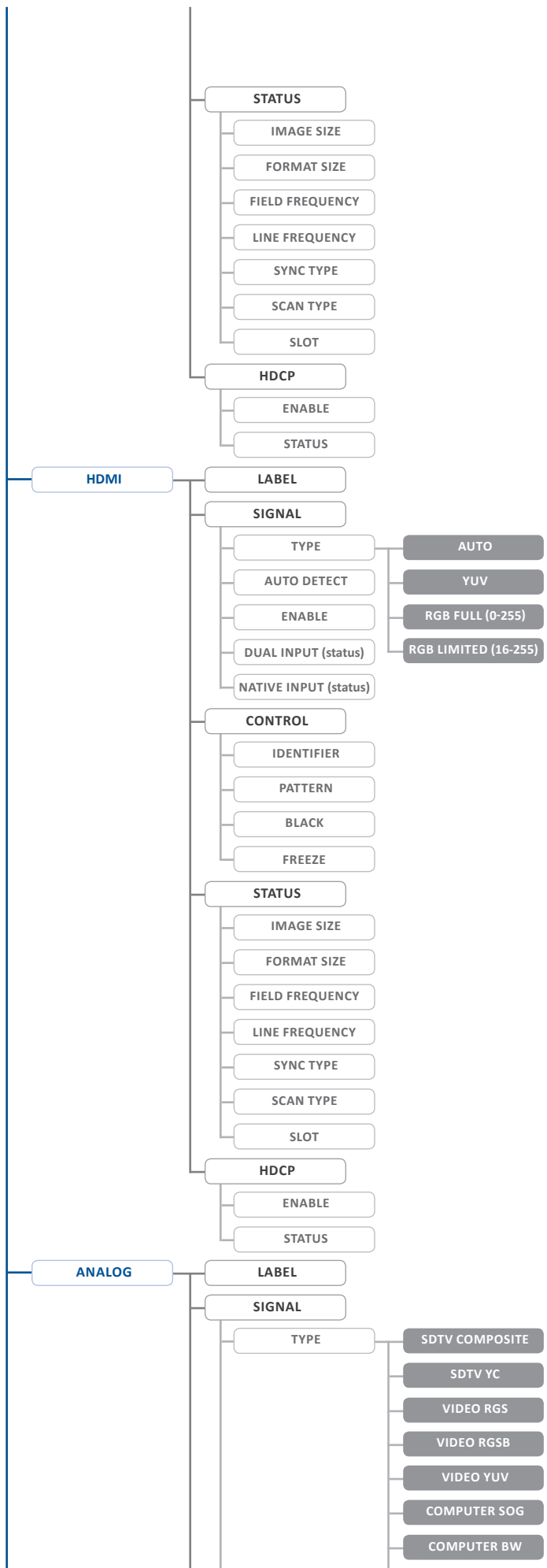



[...]

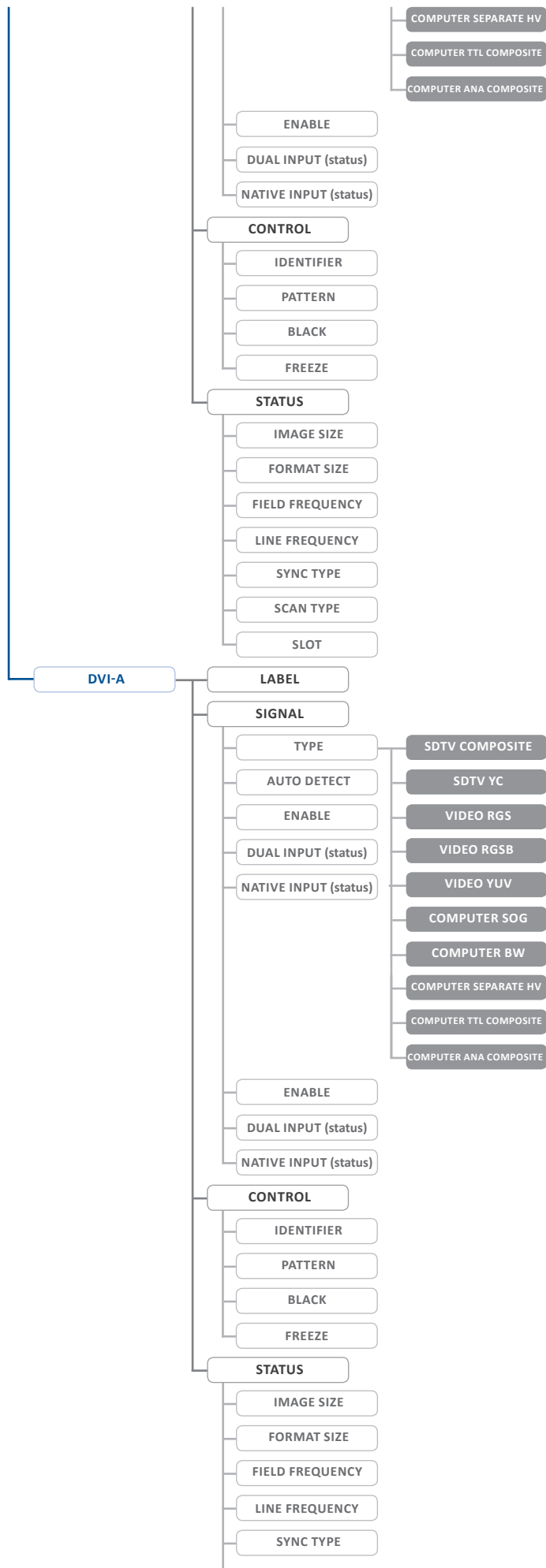

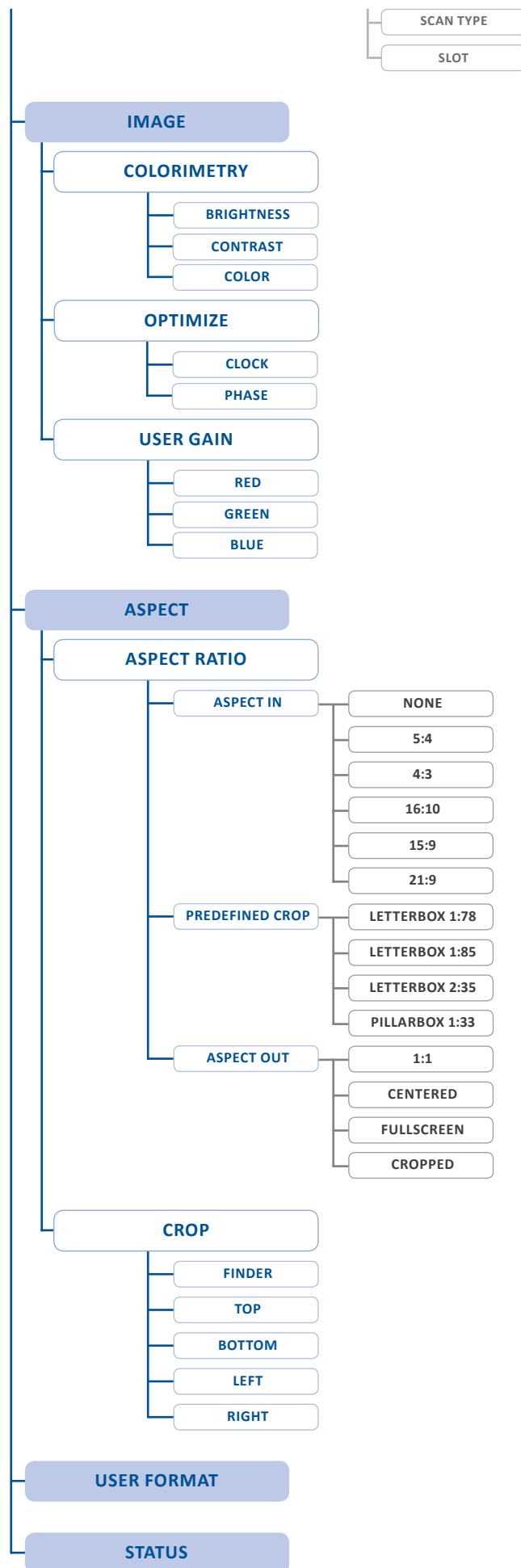

[...]

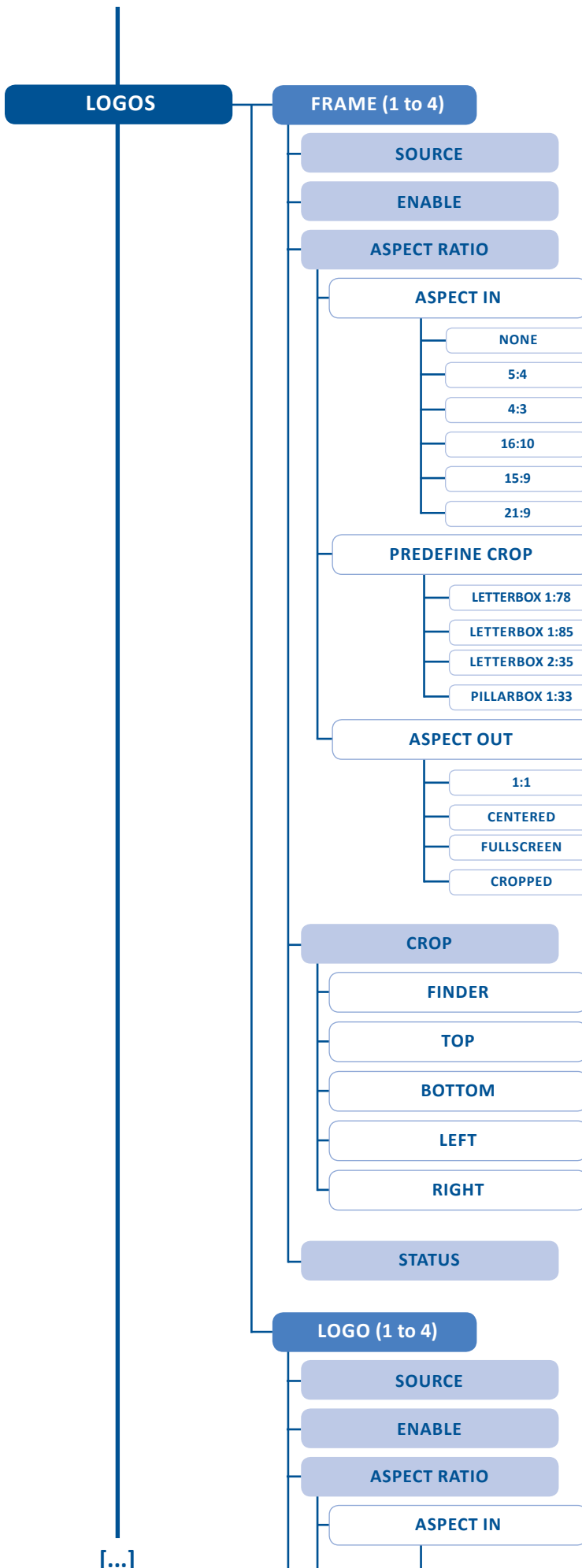

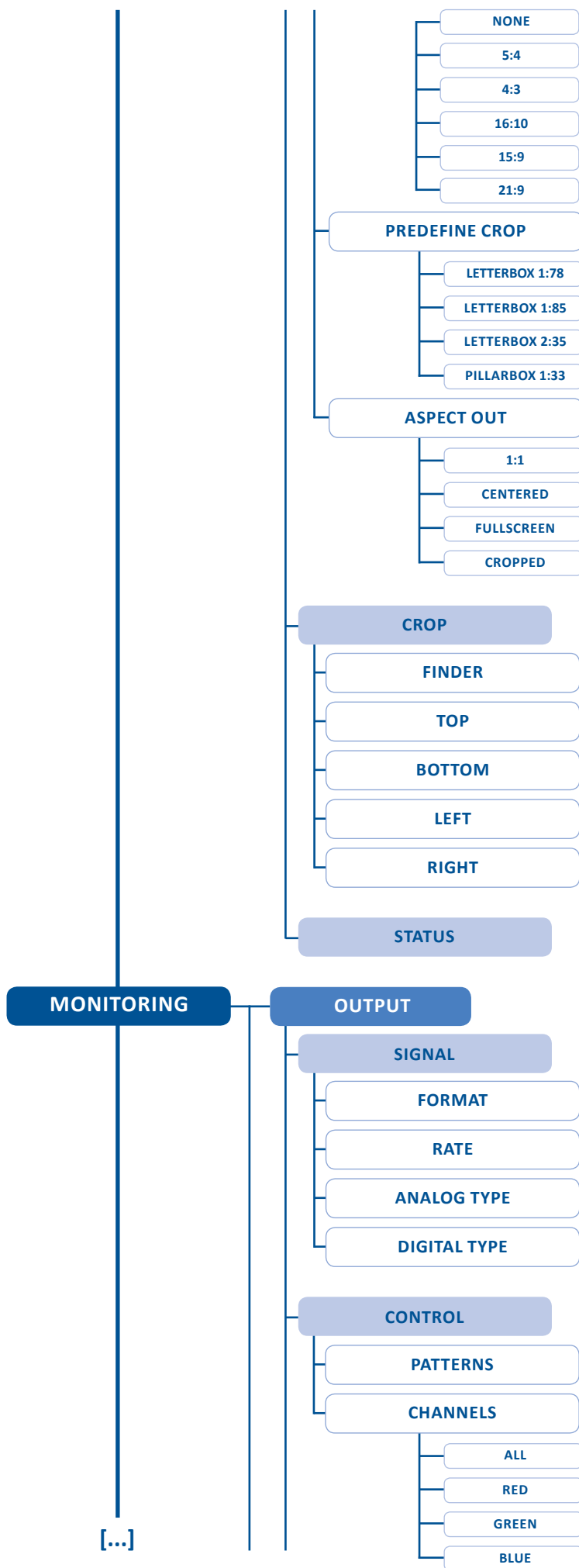

[...]

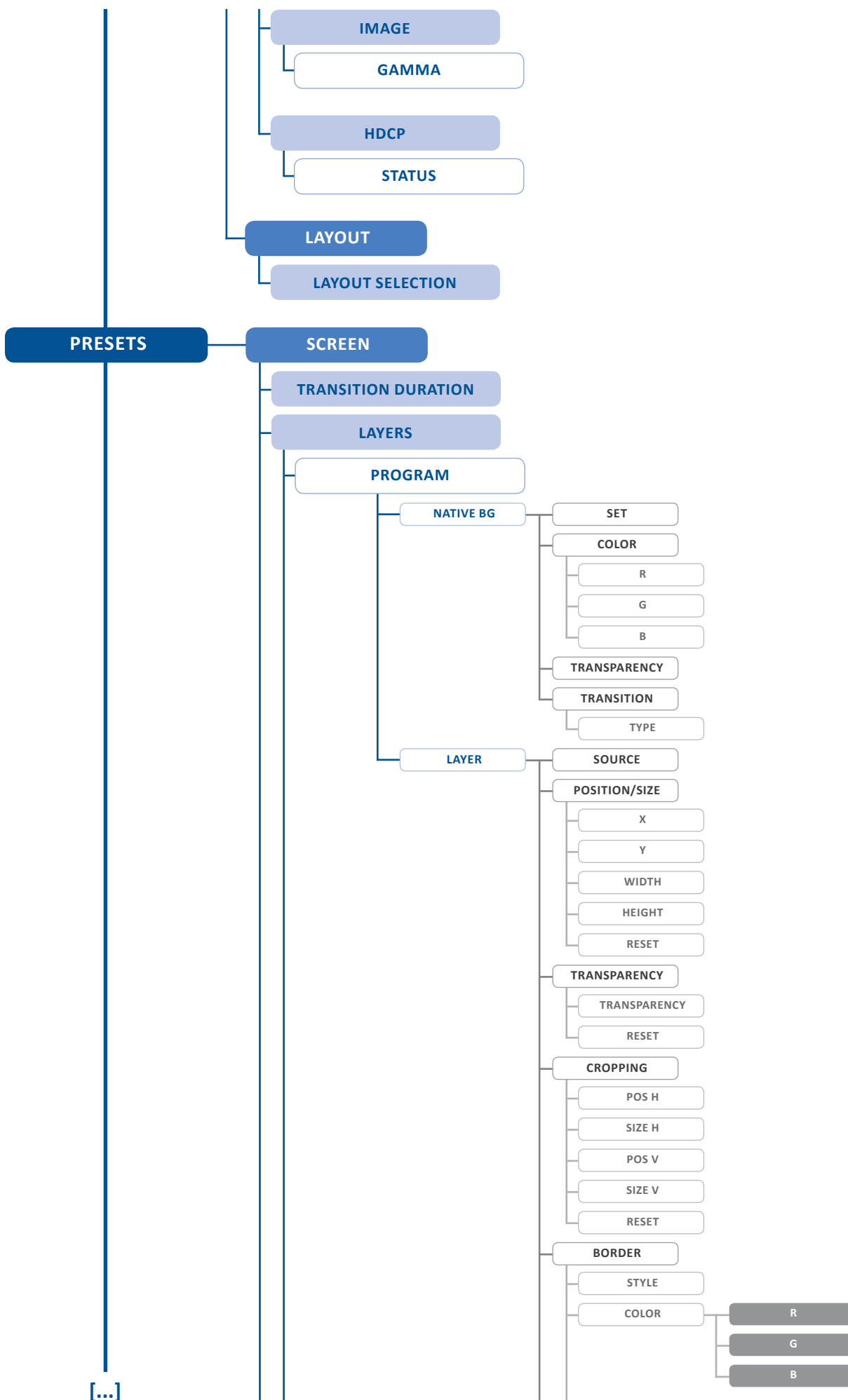

[...]

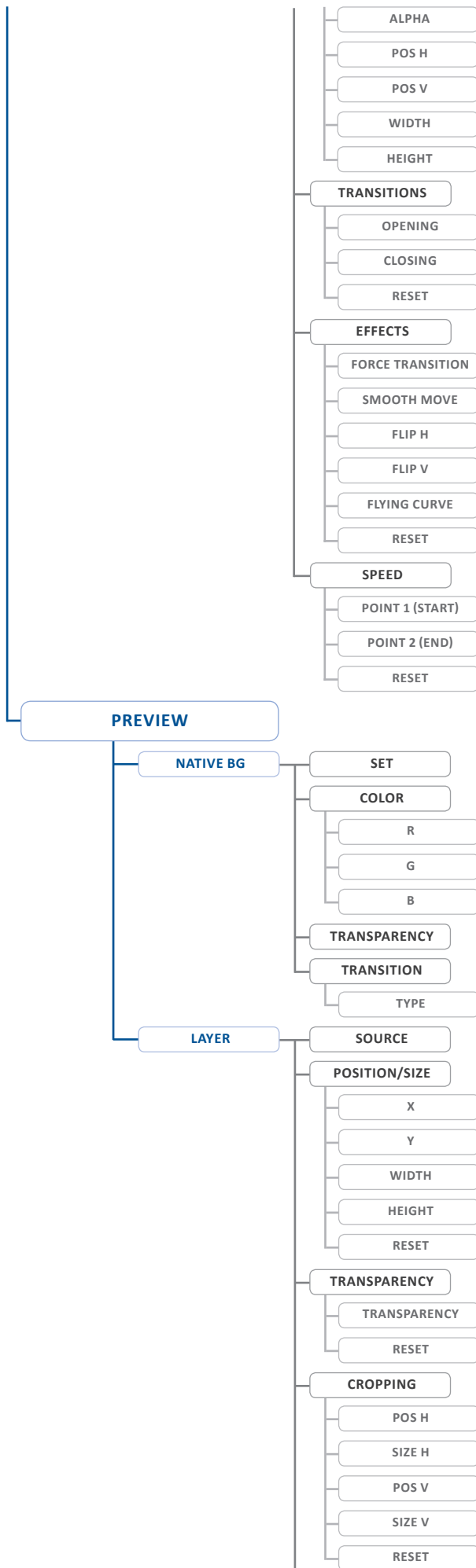

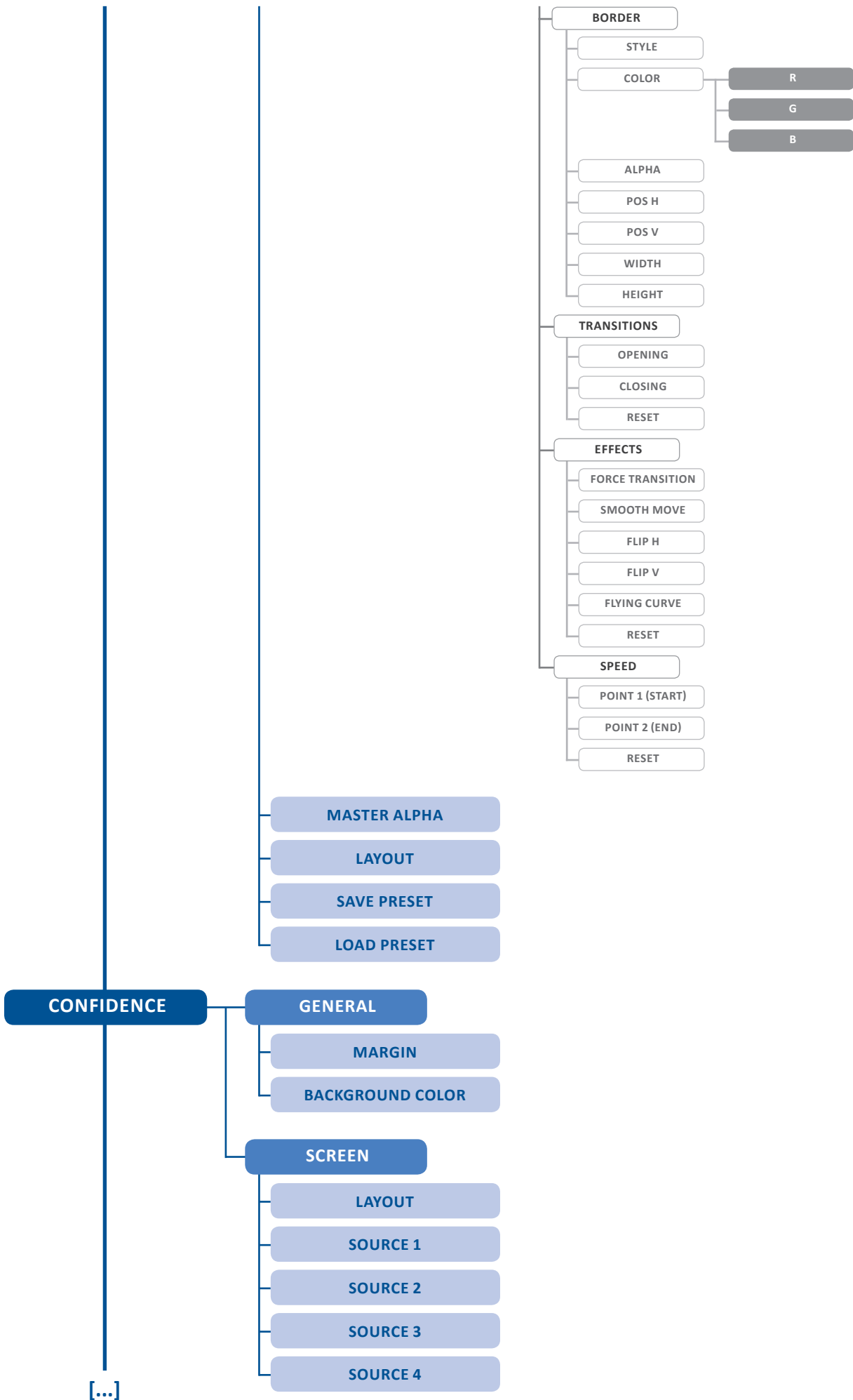

[...]

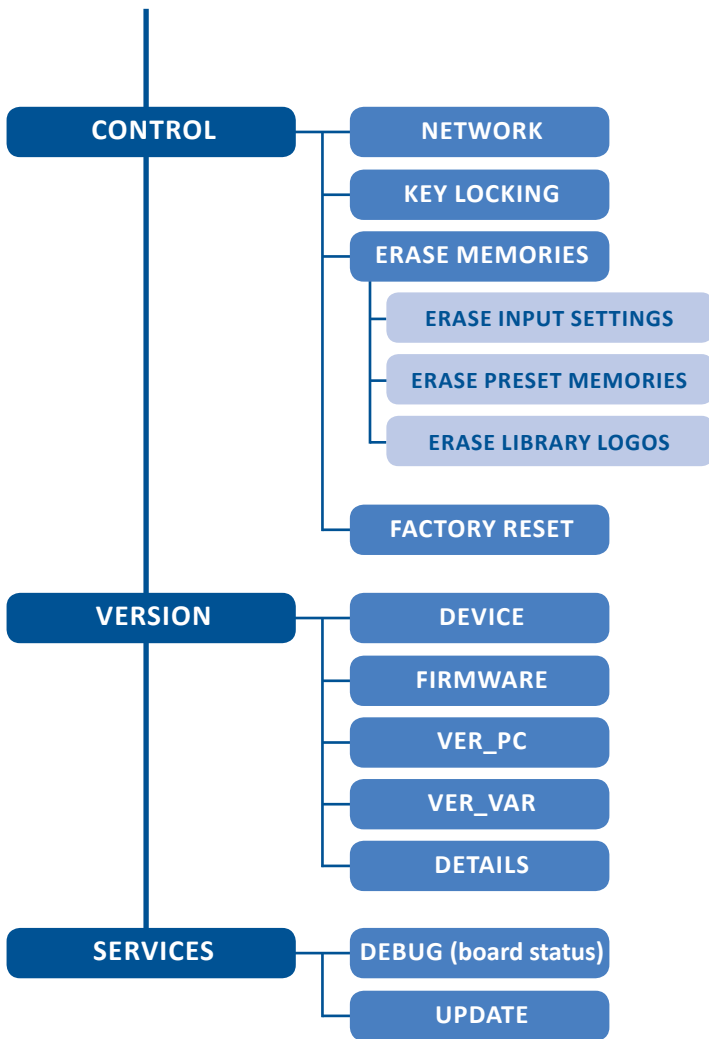



## 9. ADDITIONAL REMOTE CONTROL SYSTEMS

Your **LiveCore™ unit** offers the ability to be controlled by multiple simultaneous connections. This functionality allows for multiple operator stations and operators. For example, one operator may connect a computer using the Web RCS and focus their efforts on managing Screen 1, while a second operator connects a second computer and uses the Web RCS to manage Screen 2, 3 or 4. A third connection might interface to a control system such as those offered by Crestron, AMX, or Extron, HRS Controls to offer custom-configured functionality such as recalling specific presets or inputs through a touchpanel.

A **LiveCore™ unit** is limited to a maximum of 5 controller connections. Attempts to connect more than this number of devices will result in a failed connection.

To take advantage of this feature, simply use an additional device and connect as described in earlier chapters. The current number of active connections can be monitored from the Dashboard (*see chapter: 11.2. Dashboard (Web RCS)*). Connections which are broken due to a network error may remain listed as active connections until the timeout period has expired.

## 10. ASSEMBLING AND DEVICES COUPLING

The **LiveCore™ unit** can be used in multiple device configuration to share information between device chassis. This can enable large setups such as a large multi-device screen blend (Hard Edge and Soft Edge).

**LiveCore™ units** can be linked in two modes:

**Additive Modularity Linked mode** allows two units (except **NeXtage 08 - 4K** and **NeXtage 16 - 4K**) to share the combined resources of up to all 24 inputs, 8 outputs, and 2 operator's monitors using a set of three LiveCore™ Link cables plus a LAN cable for synchronization. Any input can be routed to any layer on any output, and any combination of screens can be used, up to 8 outputs blended.

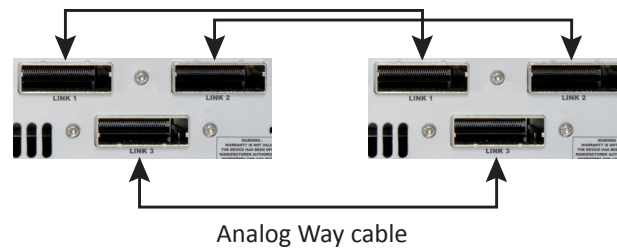

**Associative Modularity mode** allows for up to four units to be used as part of the same Assembly on the **Vertige™** console. The Device Sync connection assists with synchronization between the various units. In Associative Modularity configuration, video information must be externally split and shared with all devices in the Assembly.

### 10.1 Additive Modularity Linked mode

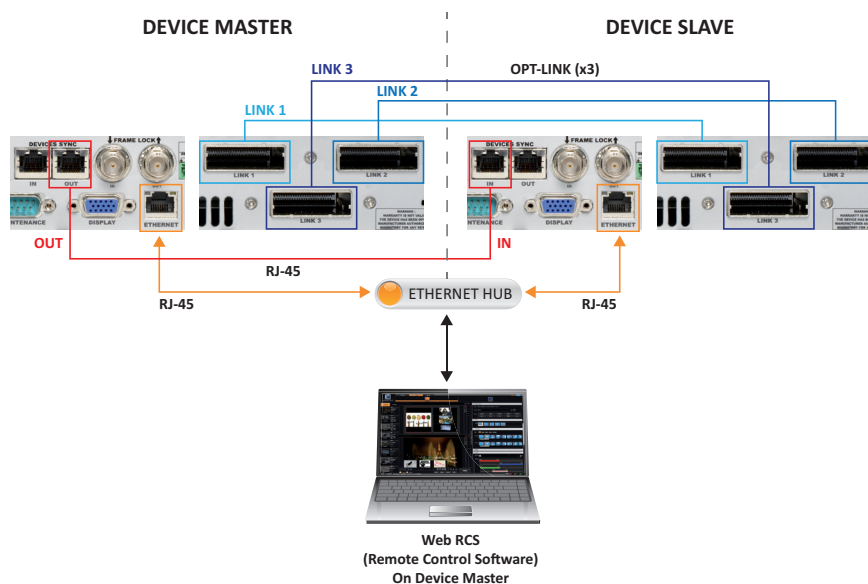

#### Heterogeneous Link support

You can link any kind of **LiveCore™ Ascenders** together while preserving the inherent capabilities of each unit (no downgrade of the most powerful unit is necessary). The **SmartMatrix Ultra** (ref. SMX12x4) can also be linked but only to another **SmartMatrix Ultra**.

Once the two devices are wired up, ensure that all devices have unique IP addresses on the network, and that the gateway IP of all devices is set correctly. If you are not using a router on the network, set all of the gateway IP addresses to the first or last IP on the network, for example 192.168.2.1 and do not use this address for any other device.

Next, start the **Web RCS** of the device that will be used as Master. Go to the **SETUP > PRECONFIG > LINKED** page on the Setup Assistant, select Linked Devices and click on the refresh button to check the connection. If all 5 connection parameters are green, click Start and the units will synchronize and self-configure for linked operation. If any configuration parameter is red, fix the error and click Refresh again.

#### NOTES:

- The 2 linked units must have the same firmware version (at least 3.01.XYZ) or you will not be able to initiate Link mode.
- 4K units can be linked to non-4K units.
- 4K Perspective Layers can be linked to non 4K non Perspective Layers units.
- The limitations of the screens are linked to the output capabilities:
  - A screen containing several outputs with different number of layers will be limited to the capabilities of the weakest output (the one with fewer layers). For example: linking an **Ascender 48 - 4K - PL** to an **Ascender 32 - 4K - PL** and creating a screen made of 2 outputs coming from both units will be limited to 4 layers. However the remaining outputs of the **Ascender 48 - 4K - PL** will still have 6 layers.
  - A screen containing outputs supporting Perspective Layers and others without this feature can't be declared as Perspective Layers.

## 10.2 Associative Modularity mode

**NOTE:** this mode requires a Vertige console.

In this mode, all live video sources must be split and shared between **LiveCore™** units using a splitter, a matrix router, etc., and the **LiveCore™** Link cables are not required. Instead, the Device Sync cables are used to share control and timing information between units. Control of the units is managed by the **Vertige™** console through the LAN network.

In cases where the blended screen involves more than one LiveCore™ unit device, it becomes desirable to improve the synchronization or effects and transitions between the multiple units, to ensure the consistency of any moving images which cross the boundary between devices. The **LiveCore™** unit offers a pair of Device Link ports for this purpose.

To use the Device Link Sync feature in any multi-device setup, you will need one standard straight CAT5 ethernet cable. Start by connecting the Cat5 cable from the Device Link output RJ-45 jack of device 1 to the Device link input RJ-45 jack of device 2.

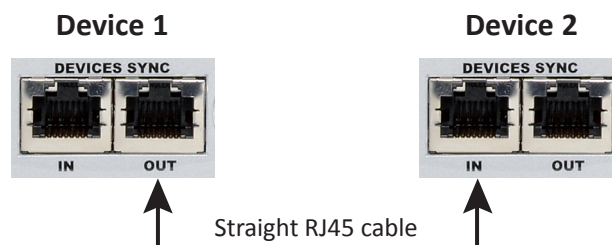

#### NOTES:

- 1/ Up to 2 devices can be connected using Device Link cables in Additive Modularity Linked mode. Up to 4 devices can be synced and controlled by the Vertige in Associative Modularity mode.
- 2/ The Cat5 based Device Link does not pass any video picture information. This link can only be used to synchronize is used to exchange the timing of effects and processing information betweenon a **LiveCore™ unit** devices used as part of the same multi-device screen blend (Hard Edge and Soft Edge). Video information should be shared using a set of specific Analog Way LiveCore™ Link cables.

3/ The **Vertige™** console is compatible with multi-device configuration (see also Device temporary downgrade below).

### Device temporary downgrade

ASC4806-4K-PL, ASC3204-4K-PL and NXT1604-4K can be temporarily downgraded to a lower model for use with the **Vertige™** console.

ASC1602-4K, SMX12x4 and NXT0802-4K models cannot be downgraded.

To downgrade a **LiveCore™** unit:

- Go to **Setup > Control** on the **Web RCS**.
- Select **Downgrade** on the leftside toolbar.
- Under **Downgraded Device**, select the device to downgrade.
- Click on the **Downgrade** button and confirm to start the downgrade procedure.

The device will reboot. Once the unit has finished rebooting, the **Live** Web RCS page will load. The Downgraded Device icon at the top right corner of the **Web RCS** interface indicates that the unit is working in downgraded mode.

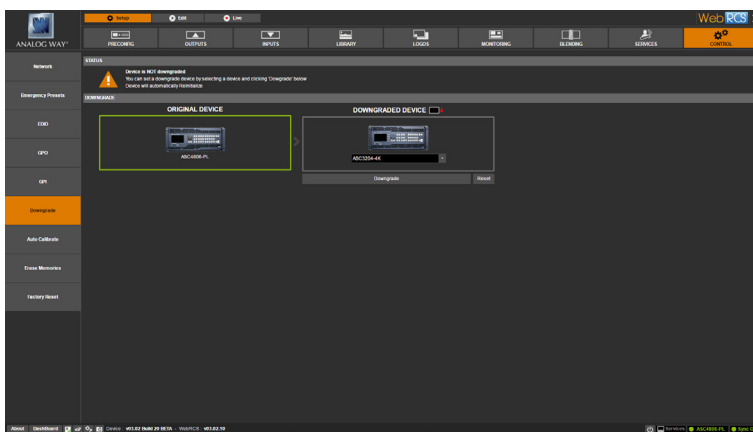

To cancel the temporary downgrade of a unit, go back to the **Downgrade** page and click on the **Reset** button to end the downgrade.

## 11. MAINTENANCE AND SUPPORT

### 11.1 Auto Calibration

A **LiveCore™** unit includes an automatic calibration system. This system will calibrate all analog outputs/inputs thanks to internal test pattern. To be sure the calibration will do in the right way, please unplug all video input/output cable. The unit is able to perform itself the calibration without any other devices plugged. Go into the **CONTROL** menu, and then auto calibrate.

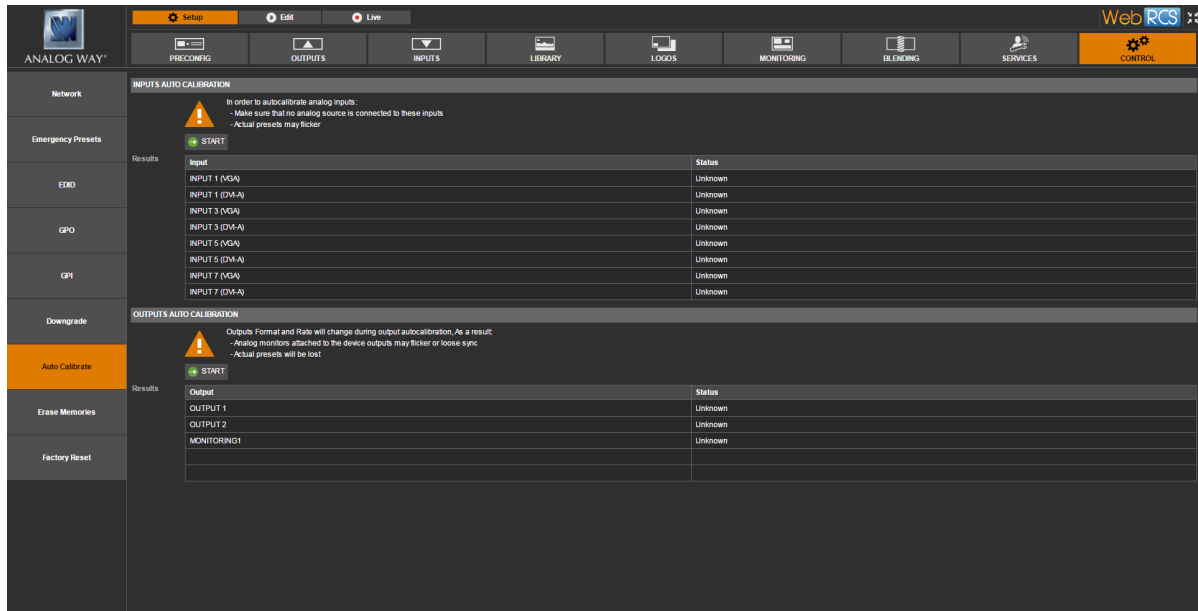

Choose Input or Output calibration and click and **START** button to launch the process.

**NOTE:** Don't press **START** if you are running a show, live modifications can appear on your screen.  
Don't press **START** if you don't need any calibration.

## 11.2 Dashboard (Web RCS)

On the **Web RCS**, you have access to a chart with global information on the unit.

Please click on the Dashboard button: 

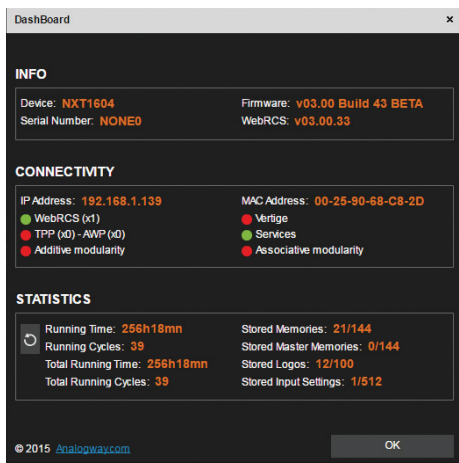

On this chart, you will find under the **INFO** tab, the Device name, the Serial number of your product, the actual firmware and the software version of the **Web RCS**.

Under **CONNECTIVITY**, you will find the current IP address of your unit and its MAC address.

Then you find a **RED/GREEN** status which give you information about the unit connectivity.

### If it is **GREEN**:

**Ethernet:** your unit is connected to your internet network

**Web RCS:** your unit is connected to a **Web RCS**, it gives you the number of connections

**Link:** thanks to the additive modularity, two devices can be linked together

**Web:** your unit is actually connected to the web (web update is available)

**Vertige:** a **Vertige™** remote controller is detected.

**Sync:** thanks to the additive modularity, two devices can be synchronized.

### If it is **RED**:

Your unit is not connected to the specific field.

Under **STATISTICS**, you can overview your **LiveCore™ unit** use information. Find the running time since the last boot, or the total running time since you bought the unit. Running Cycles, stored presets number, stored Logos number and stored input settings information are also available.



This icon provides to take a screenshot of the **Web RCS**.

## 12. APPLICATIONS NOTE AND TIPS

### 12.1 HDCP

HDCP is a content protection mechanism which uses encryption to prevent high value content from being delivered to non-authorized devices. For example, Blu-ray players use HDCP on their HDMI outputs to ensure that the HDMI output cannot be routed to a digital recording device.

**LiveCore™ unit** is fully HDCP compliant, meaning that you will be able to use the **LiveCore™ unit** to accept HDCP protected sources and route them to any HDCP protected outputs. As Analog Way is a licenced HDCP adaptor, this also means that the **LiveCore™ unit** is prevented from displaying any HDCP protected images on any non-HDCP compliant outputs (as is the case for all licenced HDCP compliant devices).

HDCP can only be used on certain connection formats, including DVI, HDMI, and DisplayPort. Keep in mind that simply because a connection is using a DVI, HDMI, or DisplayPort connection, it does not guarantee that the devices connected are maintaining an active HDCP connection. For example, you may find video recording or capture devices equipped with an HDMI input, however HDCP licencing forbids these devices from capturing HDCP protected content.

HDCP is not supported on connection formats such as composite, component, Svideo, SD-SDI, HD-SDI, 3G-SDI, or VGA. This means that any source which becomes protected by HDCP cannot be converted to these formats. For example, while you may find a Blu-ray player which can directly output a composite video signal, HDCP licencing forbids converting the HDCP protected HDMI signal back to composite or any other non-protected format.

To help troubleshoot HDCP in your installation, **LiveCore™ unit** offers a convenient HDCP map as well as HDCP status information. To access the HDCP map, use the Web RCS and navigate to the **SETUP > CONTROL > HDCP Map** page. Each input and output page is also equipped with HDCP status information to indicate in realtime when HDCP encryption is being used.

Certain devices such as Macintosh computers can be particularly tricky to use in conjunction with an HDCP compliant presentation switcher such as the **LiveCore™ unit**. This is because devices like the Mac computers can be used to output both HDCP protected content (such as a movie downloaded from iTunes) as well as non-HDCP protected content (such as a Keynote presentation or the desktop).

When a computer first connects to an HDCP compliant device such as the **LiveCore™ unit**, it learns the capabilities of the device through the EDID connection. Upon seeing the HDCP compatibility of the attached **LiveCore™ unit**, devices like the Mac computers will immediately attempt to use HDCP encryption at all times, despite the content currently displayed on the computer screen.

Since this source would now be considered as an HDCP protected source, **LiveCore™ unit** would be required to prevent it from being displayed on VGA or SDI outputs and only allow it to be displayed on outputs protected by HDCP. To work around this problem, **LiveCore™ unit** allows the HDCP features of a particular input to be disabled, which in turn informs the Mac computer to avoid using HDCP, and allows content such as Keynote and the desktop to be displayed, as this input will no longer use HDCP protection.

Please note that disabling the HDCP features of the input do not circumvent HDCP protections, and thus do not allow you to view any content which requires this protection.

For more information about HDCP, please refer to our whitepapers on HDCP, or visit the HDCP foundation website.

## 13. WARRANTY

### 13.1 Warranty conditions

Analog Way warrants the product against any defects in materials and workmanship for a period of three (3) years from the date of purchase when used in accordance with the user's manual and standard industry practices.

- In the unlikely event of any malfunction from such defects during the warranty period, Analog Way will, at its discretion, repair or replace the defective units.
- The warranty does not apply if the product is determined to have been:
  - Improperly installed or abused,
  - Handled with improper care,
  - Used or stocked in abnormal conditions,
  - Modified, opened,
  - Damaged by fire, war, or Natural disasters (Acts of God)
- Analog Way's direct employees are solely authorized to make this determination.
- Analog Way reserves the right to refuse for repair and service a product for which the warranty is void.
- In no way shall Analog Way be responsible for direct or indirect loss of profit or consequential damages resulting from any defect in this product.

**NOTE:** Analog way provides a warranty extension of 2 years, it includes parts, labor and return shipping. If you are interested, please get contact with your area sales representative.

### 13.2 Repair and return instructions

These Return Material Authorization (RMA) regulations determine the procedure to be followed when returning defective product. The aim is to ensure fast and simple handling of the returned product and bring the best satisfaction

In the unlikely event that a product is required to return for repair, please call the regional Maintenance center / Customer Service, and ask to receive a Return Material Authorization number (RMA). Three regional maintenance centers are available depending on your location. (*See chapter: 14. Contact information*)

- Before sending any device to Analog Way, please contact us to obtain a Return Material Authorization (RMA) number. Please have the model and serial number available and the reason for calling.
- RMAs are valid for 30 days, after which a new RMA must be requested.
- Package the unit securely in the original shipping materials or suitable equivalent. Analog Way is not responsible for damage which occurs due to improper packaging. The customer assumes responsibility until the unit arrives at our facility.
- Out-of-warranty products will be charged evaluation fee if no problems are found or if you choose not to proceed with the repair.
- Discontinued products are not admitted for return and repair.
- Be sure to include the RMA number clearly on the shipping label or on the exterior of the package.
- No unit will be accepted without a valid RMA clearly visible.

### 13.3 Return conditions

In the unlikely event that you want to return the product, please call the regional Maintenance center / Customer Service

- If you are unhappy with the performance of any product purchased from us, you can return it within 30 days of purchase.
- Returned equipment must be in original condition with all accessories and packaging materials.
- Returns may be subject to a refurbishment and/or restocking fee.



## 14. CONTACT INFORMATION

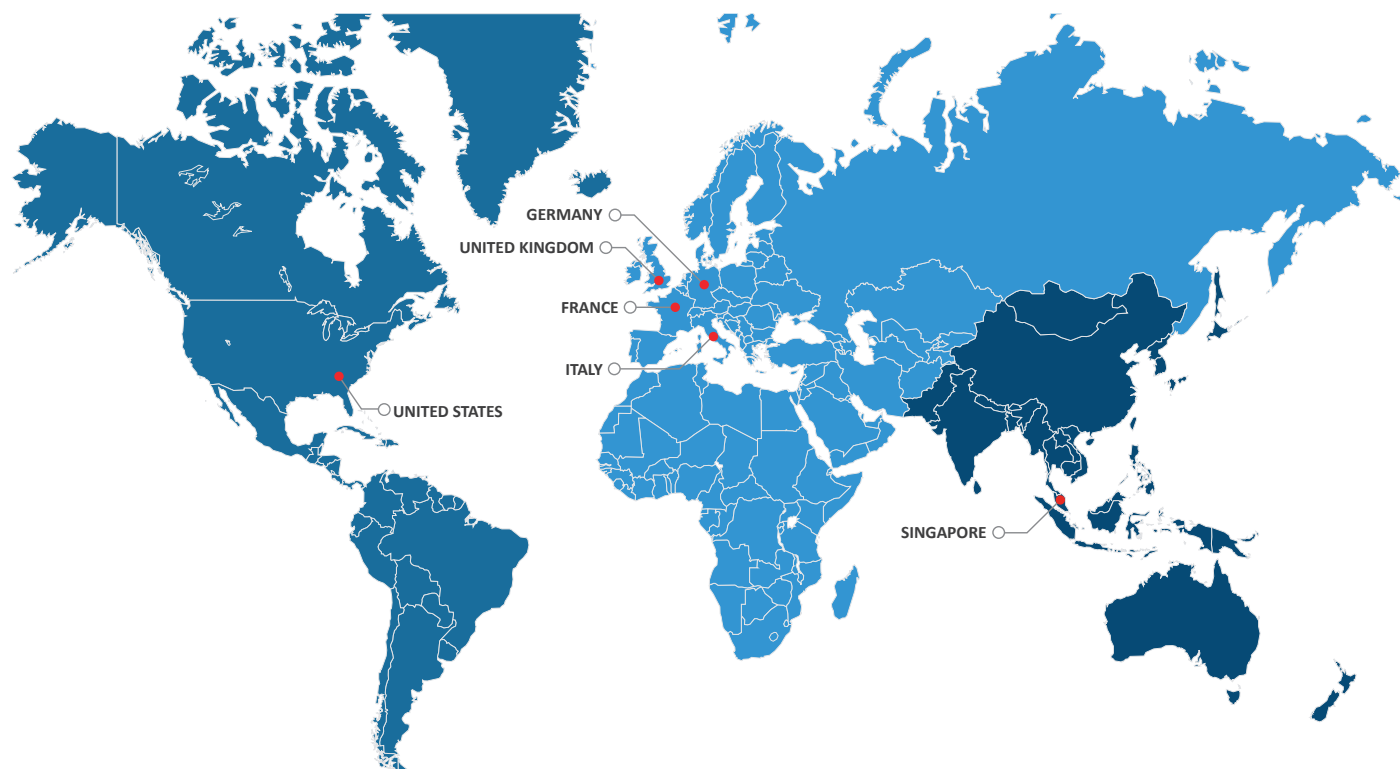

- The Americas
- Europe, Middle East & Africa
- Asia Pacific

### Analog Way SAS - Headquarters

Tel.: +33 (0)1 81 89 08 60  
 Fax: +33 (0)1 57 19 04 54  
 2/4 rue Georges Besse  
 92160 Antony  
 FRANCE

**Sales/General information:**  
[saleseuro@analogway.com](mailto:saleseuro@analogway.com)

**Technical support:**  
[techsupport@analogway.com](mailto:techsupport@analogway.com)  
 Tel.: +33 (0)1 81 89 08 76

**Analog Way Germany**  
 Tel.: +49 (0)160 97 539 542  
[salesgermany@analogway.com](mailto:salesgermany@analogway.com)

### Analog Way Inc.

Tel.: +1 678 487 6644  
 Toll free: +1 855 353 4988  
 Fax: +1 212 269 1943  
 3047 Summer Oak Place  
 Buford, GA 30518  
 USA

**Sales/General information:**  
[salesusa@analogway.com](mailto:salesusa@analogway.com)

**Technical support:**  
[techsupportusa@analogway.com](mailto:techsupportusa@analogway.com)

**Analog Way Italy**  
 Tel.: +39 02 39493943  
[salesitaly@analogway.com](mailto:salesitaly@analogway.com)

### Analog Way Pte Ltd

Tel.: +65 6292 5800  
 Fax: +65 6292 5205  
 152 Beach Road  
 #15-03 Gateway East  
 SINGAPORE 189721

**Sales/General information:**  
[sales@analogwayasia.com](mailto:sales@analogwayasia.com)

**Technical support:**  
[techsupport@analogwayasia.com](mailto:techsupport@analogwayasia.com)

**Analog Way UK**  
 Tel.: +44 (0)7774 143472  
[salesuk@analogway.com](mailto:salesuk@analogway.com)

## 15. APPENDICES

### Web RCS Visual settings

Since **LiveCore™** firmware v2.00.46, the Web RCS can store specific user interface preferences into the device memory, automatically loaded at the beginning of the next session.

This appendix lists the different UI elements that can be persisted between sessions.

*Note: These preferences are eligible for backup/restore just like the rest of the machine configuration.*

#### • INTRODUCTION

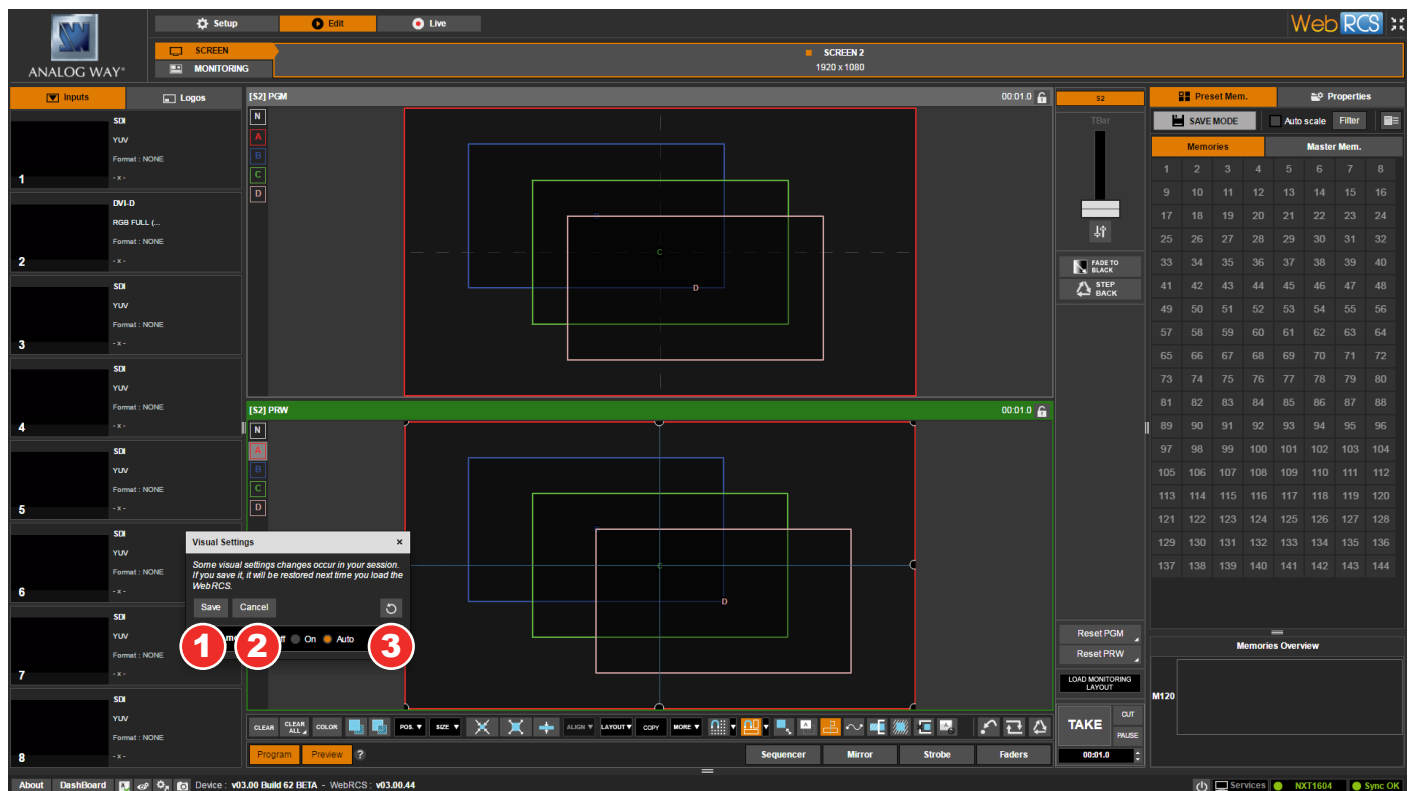

| Number | Description   |
|--------|---|
| 1      | <b>SAVE:</b> Saves current UI preferences into the device memory (any other Web RCS sessions running in parallel must be restarted to reflect changes). The following Web RCS sessions will use these settings automatically. |
| 2      | <b>CANCEL:</b> Cancel any changes made on the Web RCS UI preferences during this session and restore latest saved UI settings.  |
| 3      | <b>SET TO DEFAULT:</b> Reset Web RCS UI preferences to the default values (any other Web RCS sessions must be restarted to reflect changes).  |

## • EDIT / LIVE VIEW

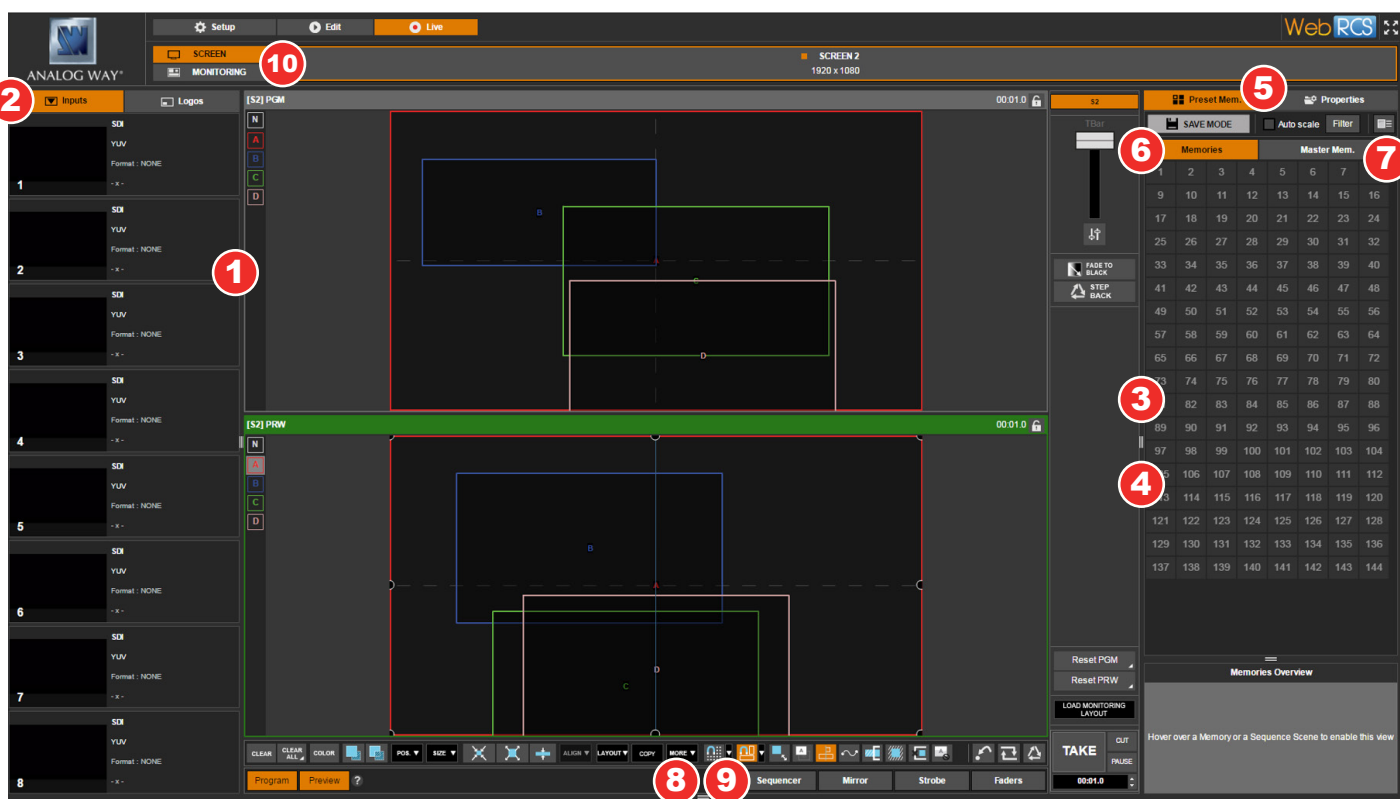

| Number | Description  |
|--------|--|
| 1      | Whether the Input/Logos Panel is opened or not (Left side)   |
| 2      | Whether the 'Input' or 'Logos' is selected in the Input/Logos Panel (Left side)                      |
| 3      | Whether the Memories/Properties Panel is opened or not (Right side)                                  |
| 4      | Width of the Memories/Properties Panel (Right side)  |
| 5      | Whether the 'Memories' or 'Properties' is selected in the Memories/Properties Panel (Right side)     |
| 6      | Whether the 'Memories' or 'Master Memories' is selected in the Memories/MasterMem Panel (Right side) |
| 7      | Whether the labels of the memories are visible or not on the Memories/MasterMem Panel (Right side)   |
| 8      | Whether the sequencer is opened or not (bottom button SEQUENCER)                                     |
| 9      | Height of the sequencer panel (bottom)   |
| 10     | Whether the 'Screen' or 'Monitoring' is selected in the top selectors                                |

## • PRESET EFFECT VIEW



| Number | Description  |
|--------|--|
| 1      | Whether the Mirror Panel is opened or not (bottom button MIRROR) |
| 2      | Whether the Strobe Panel is opened or not (bottom button STROBE) |
| 3      | Whether the Faders Panel is opened or not (bottom button FADERS) |
| 4      | Whether the program is visible or not (bottom button PROGRAM)    |
| 5      | Whether the preview is visible or not (bottom button PREVIEW)    |

## • PRESET VIEW MODES



| Number | Description   |
|--------|---|
| 1      | Whether the aspect ratio is maintained or not (Keep Aspect Ratio button)                        |
| 2      | Whether the snapshots are visible on layers or not (Toggle Wireframe button)                    |
| 3      | Whether the alignment guides are visible on layers or not (Show alignment guides button)        |
| 4      | Whether the outside area of the screen is visible or not (Show layers outside screen button)    |
| 5      | Whether the pos/size of the layer are constrained or not (No Layer Pos/Size constraints button) |
| 6      | Whether the unused layers are visible or not (Toggle unused layers visibility button)           |
| 7      | Whether the layers are constrained inside the screen or not (Trap layers on screen button)      |
| 8      | Whether the Flying Curves are visible or not (Show Flying Curve button)                         |

## • PRESET VIEW: Snap to grid / Snap to layer

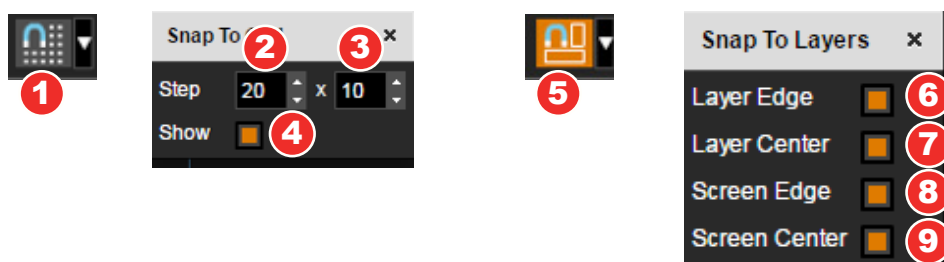

| Number | Description   |
|--------|---|
| 1      | Whether the snapToGrid is enabled or not                        |
| 2      | Columns steps for the snapToGrid grid                           |
| 3      | Rows steps for the snapToGrid grid                              |
| 4      | Whether the snapToGrid grid is visible or not                   |
| 5      | Whether the snapToLayers is enabled or not                      |
| 6      | Whether the snapToLayers triggers when Layer Edge is reached    |
| 7      | Whether the snapToLayers triggers when Layer Center is reached  |
| 8      | Whether the snapToLayers triggers when Screen Edge is reached   |
| 9      | Whether the snapToLayers triggers when Screen Center is reached |

## • MONITORING VIEW

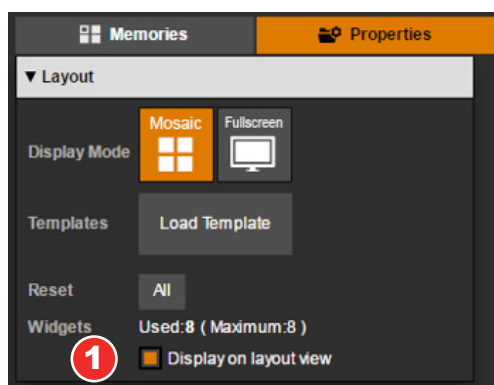

| Number | Description   |
|--------|---|
| 1      | Whether the resource for each widget are visible or not (Display on layout view button) |

• TOUCH GESTURE VIEW

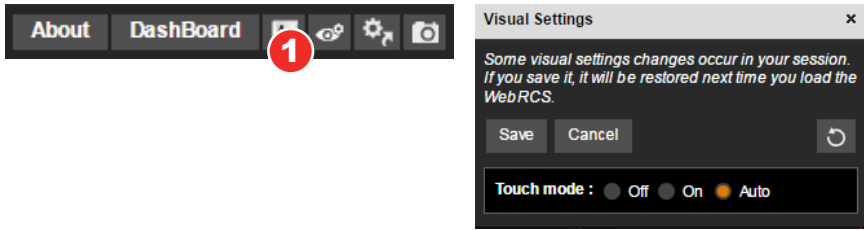

| Number | Description   |
|--------|---|
| 1      | TouchGesture mode (0: force off, 1: force on, 2: auto) when auto, the touch gesture will be on if the device supports touch devices |

• SEQUENCER VIEW

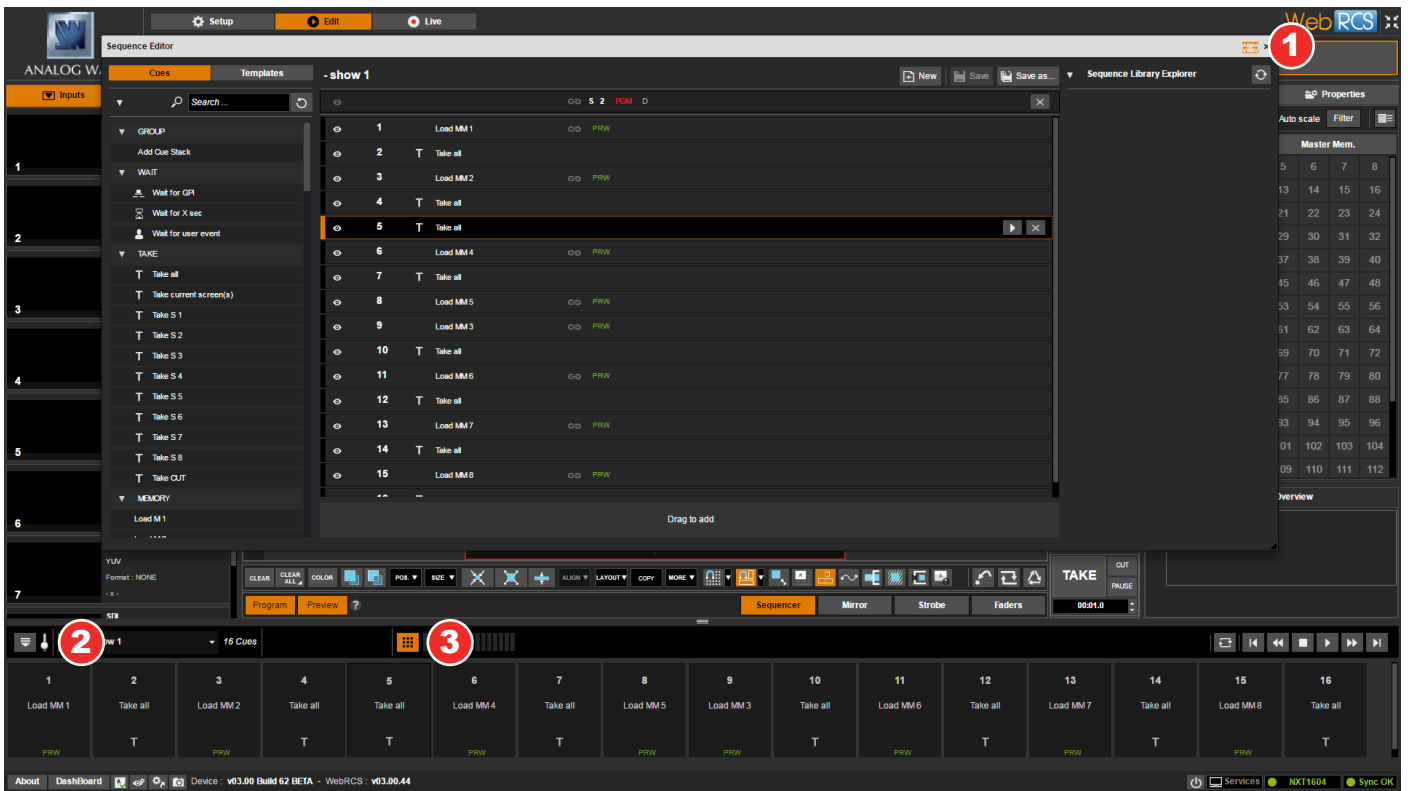

| Number | Description  |
|--------|--|
| 1      | Whether the Sequencer Tools and Library are visible or not (left and right panels) |
| 2      | Size (in pixels) of a cue on the sequencer list                                    |
| 3      | Whether the Sequencer Keypad mode is enabled or not (one-click play)               |

Connect with us on

