

**SAMSUNG**

# USER MANUAL

---

PM32F / PM43F / PM49F / PM55F

PH43F / PH49F / PH55F

---

The color and the appearance may differ depending on the product, and the specifications are subject to change without prior notice to improve the performance.

Recommended hours of use per day for the PM32F models is less than 16 hours. If the product is used for longer than 16 hours a day, the warranty may be void.

# Table of contents

## 01. Safety

<b>Safety precautions</b>	<b>5</b>
Electricity and safety	5
Installation	6
Operation	7
Storage	8
Cleaning	9
Precautions when handling the panel	9

## 02. Device setup

<b>Installation</b>	<b>10</b>
What's Included	10
Parts	11
Reverse side	12
Anti-theft lock	13
Remote control	14
Guided installation	16
<b>External connection</b>	<b>18</b>
Checkpoints	18
Cable Connection	18
Control Codes	21
PC connection	29
AV connection	32
LAN connection	34
Source selection	34

## 03. PC software (Multiple Display Control)

<b>Installation/uninstallation</b>	<b>35</b>
Installation	35
Uninstallation	35
<b>Connection</b>	<b>36</b>
Using the RS-232C cable	36
Using the ethernet cable	36

## 04. Home screen

<b>Player</b>	<b>38</b>
Viewing content	38
When content is running	39
File formats compatible with Player	39
<b>Schedule</b>	<b>44</b>
<b>URL Launcher</b>	<b>44</b>
<b>URL Launcher Setting</b>	<b>44</b>
<b>Clone Product</b>	<b>44</b>
When a duplicate file is not found on the external storage device	44
When a duplicate file is found on the external storage device	45
<b>ID Settings</b>	<b>45</b>
Device ID	45
Device ID Auto Set	45

PC Connection Cable	45
<b>Video Wall</b>	<b>46</b>
Video Wall	46
<b>Network Status</b>	<b>46</b>
<b>Picture Mode</b>	<b>47</b>
<b>On/Off Timer</b>	<b>47</b>
On Timer	47
Off Timer	48
<b>Ticker</b>	<b>48</b>
<b>Approving a connected device from the server</b>	<b>49</b>

## 05. Menu

<b>Screen adjustment</b>	<b>51</b>
<b>OnScreen display adjustment</b>	<b>55</b>
<b>Sound adjustment</b>	<b>57</b>
<b>Broadcasting adjustment</b>	<b>58</b>
<b>Network</b>	<b>59</b>
Network Settings (Wired)	61
Network Setting (Wireless)	63
WPS(PBC)	64
<b>System</b>	<b>65</b>
Anynet+ (HDMI-CEC)	70

<a href="#">Support</a>	72
-------------------------	----

## 06. Troubleshooting

<a href="#">Before you contact us</a>	73
---------------------------------------	----

Diagnosis	73
-----------	----

Screen Resolution	73
-------------------	----

Checkpoints	74
-------------	----

Frequently asked questions	79
----------------------------	----

## 07. Appendix

<a href="#">Specifications</a>	80
--------------------------------	----

General	80
---------	----

Standard signal mode table	82
----------------------------	----

### [Responsibility for the pay service \(Cost to Customers\)](#)

84

Not a product defect	84
----------------------	----

A product damage caused by customer's fault	84
---	----

Others	84
--------	----

### [Optimum picture quality and afterimage burn-in](#)

<a href="#">prevention</a>	85
----------------------------	----

Optimum picture quality	85
-------------------------	----

Prevention of afterimage burn-in	85
----------------------------------	----

Preventing afterimage burn-in	86
-------------------------------	----

<a href="#">License</a>	87
-------------------------	----

# About this manual

## Copyright

---

The contents of this manual are subject to change without notice to improve quality.

© 2015 Samsung Electronics

Samsung Electronics owns the copyright for this manual.

Use or reproduction of this manual in parts or entirety without the authorization of Samsung Electronics is prohibited.

Microsoft, Windows are registered trademarks of Microsoft Corporation.

VESA, DPM and DDC are registered trademarks of the Video Electronics Standards Association.

Ownership of all other trademarks is attributed to their due owner.

- An administration fee may be charged if either
  - a** an engineer is called out at your request and there is no defect in the product (i.e. where you have failed to read this user manual).
  - b** you bring the unit to a repair center and there is no defect in the product (i.e. where you have failed to read this user manual).
- The amount of such administration charge will be advised to you before any work or home visit is carried out.

## Symbols

---

### WARNING

A serious or fatal injury may result if instructions are not followed.

### CAUTION

Injury or damage to property may result if instructions are not followed.

### Note

Instructions marked by this symbol must be followed.

# Safety

## Safety precautions

---

### CAUTION

RISK OF ELECTRIC SHOCK! DO NOT OPEN THE PRODUCT.

TO REDUCE THE RISK OF ELECTRIC SHOCK, DO NOT REMOVE COVER. (OR BACK)

THERE ARE NO USER SERVICEABLE PARTS INSIDE.

REFER ALL SERVICING TO QUALIFIED PERSONNEL.

## Electricity and safety

### WARNING

Do not use a damaged power cord or plug, or a loose power socket.

- An electric shock or fire may result.

Do not use multiple products with a single power socket.

- Overheated power sockets may cause a fire.

Do not touch the power plug with wet hands. Otherwise, an electric shock may result.

Insert the power plug all the way in so it is not loose.

- An unsecure connection may cause a fire.

Connect the power plug to a grounded power socket (type 1 insulated devices only).

- An electric shock or injury may result.

Do not bend or pull the power cord with force. Be careful not to leave the power cord under a heavy object.

- Damage to the cord may result in a fire or electric shock.

Do not place the power cord or product near heat sources.

- A fire or electric shock may result.

Clean any dust around the pins of the power plug or the power socket with a dry cloth.

- A fire may result.

### CAUTION

Do not disconnect the power cord while the product is being used.

- The product may become damaged by an electric shock.

Only use the power cord provided with your product by Samsung. Do not use the power cord with other products.

- A fire or electric shock may result.

Keep the power socket where the power cord is connected unobstructed.

- The power cord must be disconnected to cut off power to the product when an issue occurs.
- Note that the product is not completely powered down by using only the power button on the remote.

Hold the plug when disconnecting the power cord from the power socket.

- An electric shock or fire may result.

## Installation

### WARNING

Do not place candles, insect repellants or cigarettes on top of the product. Do not install the product near heat sources.

- A fire may result.

Have a technician install the wall-mount hanger.

- Installation by an unqualified person can result in an injury.
- Only use approved cabinets.

Do not install the product in poorly ventilated spaces such as a bookcase or closet.

- An increased internal temperature may cause a fire.

Install the product at least 4 inches(10 cm) away from the wall to allow ventilation.

- An increased internal temperature may cause a fire.

Keep the plastic packaging out of the reach of children.

- Children may suffocate.

Bend and keep part of the outdoor TV antenna cable hanging downwards (the part inside the room) to prevent rainwater from entering the product.

- If rainwater enters the product, a fire or electric shock can occur.

When using an outdoor antenna, be sure to install the antenna away from nearby power lines to prevent the antenna from collapsing onto them in strong winds.

- A collapsed antenna can cause an electric shock or injury.

Do not install the product on an unstable or vibrating surface (insecure shelf, sloped surface, etc.)

- The product may fall and become damaged and/or cause an injury.
- Using the product in an area with excess vibration may damage the product or cause a fire.

Do not install the product in a vehicle or a place exposed to dust, moisture (water drips, etc.), oil, or smoke.

- A fire or electric shock may result.

Do not expose the product to direct sunlight, heat, or a hot object such as a stove.

- The product lifespan may be reduced or a fire may result.

Do not install the product within the reach of young children.

- The product may fall and injure children.
- As the front is heavy, install the product on a flat and stable surface.

Edible oil, such as soybean oil, can damage or deform the product. Do not install the product in a kitchen or near a kitchen counter.

### CAUTION

Do not drop the product while moving.

- Product failure or personal injury may result.

Do not set down the product on its front.

- The screen may become damaged.

When installing the product on a cabinet or shelf, make sure that the bottom edge of the front of the product is not protruding.

- The product may fall and become damaged and/or cause an injury.
- Install the product only on cabinets or shelves of the right size.

Set down the product gently.

- Product failure or personal injury may result.

Installing the product in an unusual place (a place exposed to a lot of fine dust, chemical substances, extreme temperatures or a significant presence of moisture, or a place where the product will operate continuously for an extended period of time) may seriously affect its performance.

- Be sure to consult Samsung Customer Service Center if you want to install the product at such a place.

## Operation

### WARNING

There is a high voltage inside the product. Never disassemble, repair or modify the product yourself.

- A fire or electric shock may result.
- Contact Samsung Customer Service Center for repairs.

Before moving the product, turn off the power switch and disconnect the power cable and all other connected cables.

- Damage to the cord may result in a fire or electric shock.

If the product generates abnormal sounds, a burning smell or smoke, disconnect the power cord immediately and contact Samsung Customer Service Center.

- An electric shock or fire may result.

Do not let children hang from the product or climb on top of it.

- Children may become injured or seriously harmed.

If the product is dropped or the outer case is damaged, turn off the power switch and disconnect the power cord. Then contact Samsung Customer Service Center.

- Continued use can result in a fire or electric shock.

Do not leave heavy objects or items that children like (toys, sweets, etc.) on top of the product.

- The product or heavy objects may fall as children try to reach for the toys or sweets resulting in a serious injury.

During a lightning or thunderstorm, power off the product and remove the power cable.

- A fire or electric shock may result.

Do not drop objects on the product or apply impact.

- A fire or electric shock may result.

Do not move the product by pulling the power cord or any cable.

- Product failure, an electric shock or fire may result from a damaged cable.

If a gas leakage is found, do not touch the product or power plug. Also, ventilate the area immediately.

- Sparks can cause an explosion or fire.

Do not lift or move the product by pulling the power cord or any cable.

- Product failure, an electric shock or fire may result from a damaged cable.

Do not use or keep combustible spray or an inflammable substance near the product.

- An explosion or fire may result.

Ensure the vents are not blocked by tablecloths or curtains.

- An increased internal temperature may cause a fire.

Do not insert metallic objects (chopsticks, coins, hairpins, etc) or objects that burn easily (paper, matches, etc) into the product (via the vent or input/output ports, etc).

- Be sure to power off the product and disconnect the power cord when water or other foreign substances have entered the product.  
Then contact Samsung Customer Service Center.
- Product failure, an electric shock or fire may result.

Do not place objects containing liquid (vases, pots, bottles, etc) or metallic objects on top of the product.

- Be sure to power off the product and disconnect the power cord when water or other foreign substances have entered the product.  
Then contact Samsung Customer Service Center.
- Product failure, an electric shock or fire may result.

### CAUTION

Leaving the screen fixed on a stationary image for an extended period of time may cause afterimage burn-in or defective pixels.

- Activate power saving mode or a moving-picture screen saver if you will not be using the product for an extended period of time.

Disconnect the power cord from the power socket if you do not plan on using the product for an extended period of time (vacation, etc).

- Dust accumulation combined with heat can cause a fire, electric shock or electric leakage.

Use the product at the recommended resolution and frequency.

- Your eyesight may deteriorate.

Do not hold the product upside-down or move it by holding the stand.

- The product may fall and become damaged or cause an injury.

Looking at the screen too close for an extended period of time can deteriorate your eyesight.

Do not use humidifiers or stoves around the product.

- A fire or electric shock may result.

Rest your eyes for more than 5 minutes for every 1 hour of product use.

- Eye fatigue will be relieved.

Do not touch the screen when the product has been turned on for an extended period of time as it will become hot.

Store small accessories out of the reach of children.

Exercise caution when adjusting the product angle or stand height.

- Your hand or finger may get stuck and injured.
- Tilting the product at an excessive angle may cause the product to fall and an injury may result.

Do not place heavy objects on the product.

- Product failure or personal injury may result.

When using headphones or earphones, do not turn the volume too high.

- Having the sound too loud may damage your hearing.

Be careful that children do not place the battery in their mouths when removed from the remote control. Place the battery in a location that children or infants cannot reach.

- If children have had the battery in their mouths, consult your doctor immediately.

When replacing the battery, insert it with the right polarity (+, -).

- Otherwise, the battery may become damaged or it may cause fire, personal injury or damage due to leakage of the internal liquid.

Use only the specified standardized batteries, and do not use a new battery and a used battery at the same time.

- Otherwise, the batteries may be damaged or cause fire, personal injury or damage due to a leakage of the internal liquid.

The batteries (and rechargeable batteries) are not ordinary refuse and must be returned for recycling purposes. The customer is responsible for returning the used or rechargeable batteries for recycling.

- The customer can return used or rechargeable batteries to a nearby public recycling center or to a store selling the same type of the battery or rechargeable battery.

## Storage

Due to the characteristics of high-glossy products, using a UV humidifier nearby may create white-colored stains on the product.

Contact Customer Service Center if the inside of the product needs cleaning (service fee will be charged).



## Cleaning

Exercise care when cleaning as the panel and exterior are easily scratched.

Take the following steps when cleaning.

- 1** Power off the product and computer.
- 2** Disconnect the power cord from the product.
  - Hold the power cable by the plug and do not touch the cable with wet hands. Otherwise, an electric shock may result.
- 3** Wipe the product with a clean, soft and dry cloth.
  - Do not use detergents that contain alcohol, solvent or surface-active agents.
  - Do not spray water or detergent directly on the product.
- 4** Wet a soft and dry cloth in water and wring thoroughly to clean the exterior of the product.
- 5** Connect the power cord to the product when cleaning is finished.
- 6** Power on the product and computer.

## Precautions when handling the panel

Do not stand the product upright on the floor. The panel is fragile and can get damaged.

Lay the product down to handle it (the packaging can be used).

Ensure you use the handles on the back when moving the product.

Do not hold or grasp any area of the product within 0.6 inch(15 mm) from the front.

# Device setup

## Installation

---

### What's Included

- Components may differ in different locations.
- Contact the vendor where you purchased the product if any components are missing.
- The appearance of the components may differ from the images shown.
- A stand is not provided with the product. To install a stand, you can purchase one separately.
- The RS232C adapter can be used to connect to another monitor using the D-SUB (9-pin) type RS232C cable.

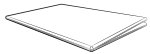

Quick Setup Guide



Warranty card (Not available in some locations)



Regulatory guide

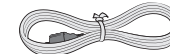

Power cord

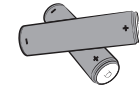

Batteries (Not available in some locations)



Remote control



RS232C(IN) adapter



Screw (M3L8, 1 piece)

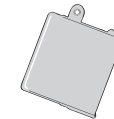

USB cover

---

## Parts

The color and shape of parts may differ from what is shown.

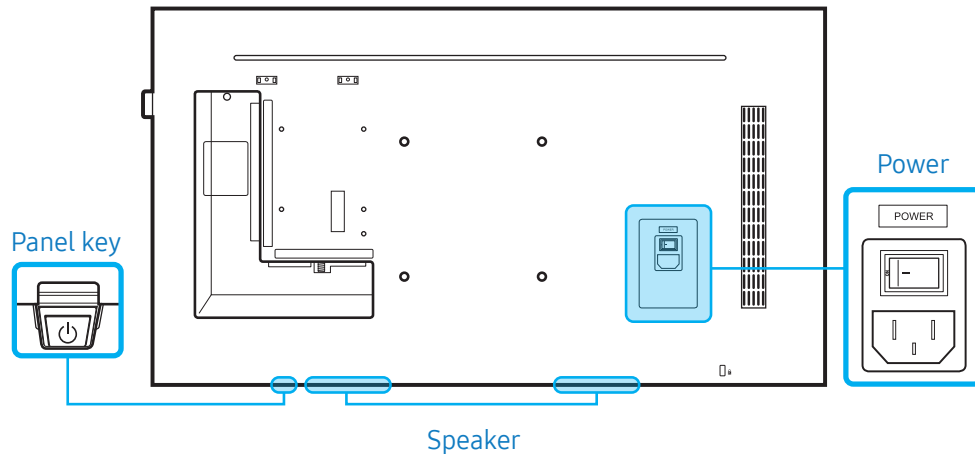

### Panel key

Press and hold for three seconds to turn on the display.

To turn off the display using the panel key, press the panel key. Then, press and hold the panel key until the display turns off.

You can also use the panel key to select a desired source. To select a source, press the panel key. A popup menu appears. Press the panel key again to select **Source**. Then, press and hold the panel key to cycle through the desired source.

- To use the panel key, make sure the sliding panel key is not protruding from the bottom of the product.
- To use remote/eco sensor, make sure the sliding panel key is protruding from the bottom of the product.

### Remote sensor and spacer logo (optional)

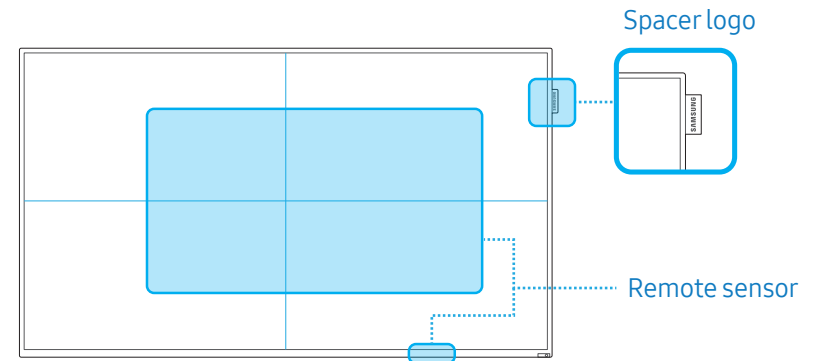

### Remote sensor

Press a button on the remote control pointing at the remote sensor on the product to perform the corresponding function.

- Using other display devices in the same space as the remote control of this product can cause the other display devices to be inadvertently controlled.

Use the remote control within 23 ft (7 m) to 33 ft (10 m) from the sensor on the product at an angle of 30° from the left and right.

The product's screen also works as a remote sensor.

When pointing the remote control at the screen, make sure:

- the remote control is pointing towards the center of the screen.
- to use the remote control 1.3 ft (40 cm) to 2.3 ft (70 cm) away from the screen.

### WARNING

Store used batteries out of reach of children and recycle.

- Do not use a new and used battery together. Replace both batteries at the same time.
- Remove batteries when the remote control is not to be used for an extended period of time.



### Spacer logo (optional)

Do not pull on the spacer logo using force. The logo may tear or break off.

### Reverse side

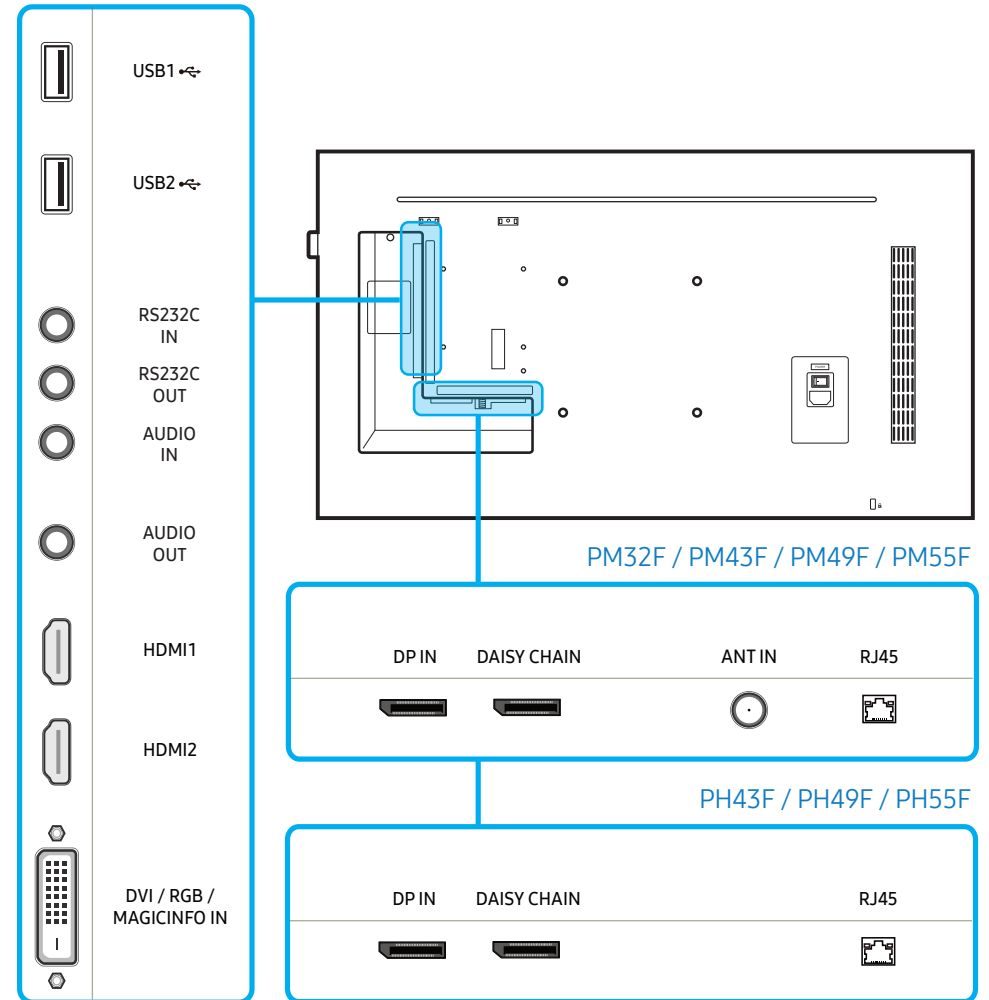
- The color and shape of parts may differ from what is shown.
- ANT IN is only available for PM32F/PM43F/PM49F/PM55F models.



Port	Description
USB1 	Connect to a USB memory device.
USB2 	
RS232C IN	Connects to MDC using an RS232C adapter.
RS232C OUT	
AUDIO IN	Receives sound from a source device via an audio cable.
AUDIO OUT	Connects to the audio of a source device.
HDMI1	Connects to a source device using an HDMI cable.
HDMI2	
DVI / RGB / MAGICINFO IN	DVI IN: Connects to a source device using a DVI cable or HDMI-DVI cable. RGB IN: Use the (dedicated) D-SUB - DVI cable (or D-SUB cable with D-SUB to DVI adapter) when connecting a PC. MAGICINFO IN: Use the (dedicated) DP-DVI cable when connecting a network box (sold separately).
DP IN	Connects to a source device using a DP cable.
DAISY CHAIN	Connects to another product using a daisy chain (DP port) cable.
ANT IN (PM32F/PM43F/ PM49F/PM55F models only)	Connect to an antenna cable.
RJ45	Connects to MDC using a LAN cable.

## Anti-theft lock

An anti-theft lock allows you to use the product securely even in public places. The locking device shape and locking method depend on the manufacturer. Refer to the user manual provided with your anti-theft locking device for details.

The following images are for reference only. Real-life situations may differ from what is shown in the images.

### To lock an anti-theft locking device:

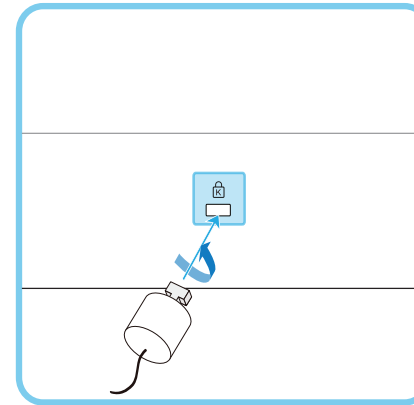

- 1 Fix the cable of your anti-theft locking device to a heavy object such as a desk.
- 2 Put one end of the cable through the loop on the other end.
- 3 Insert the locking device into the anti-theft lock slot at the back of the product.
- 4 Lock the locking device.

- An anti-theft locking device can be purchased separately. Anti-theft locking devices can be purchased at electronics retailers or online.
- Refer to the user manual provided with your anti-theft locking device for details.

## Remote control

- Using other display devices in the same space as the remote control of this product can cause the other display devices to be inadvertently controlled.
- A button without a description in the image below is not supported on the product.

Remote control button functions may differ for different products.

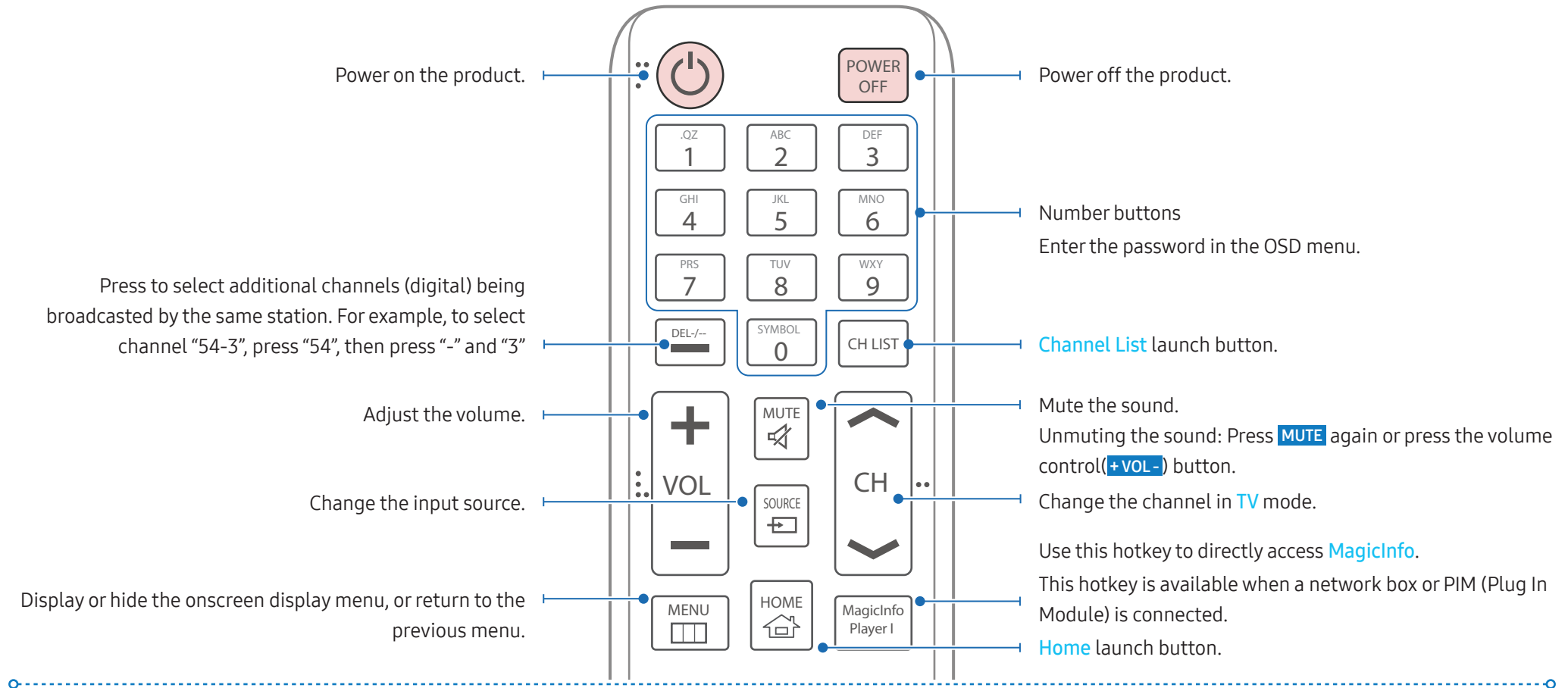

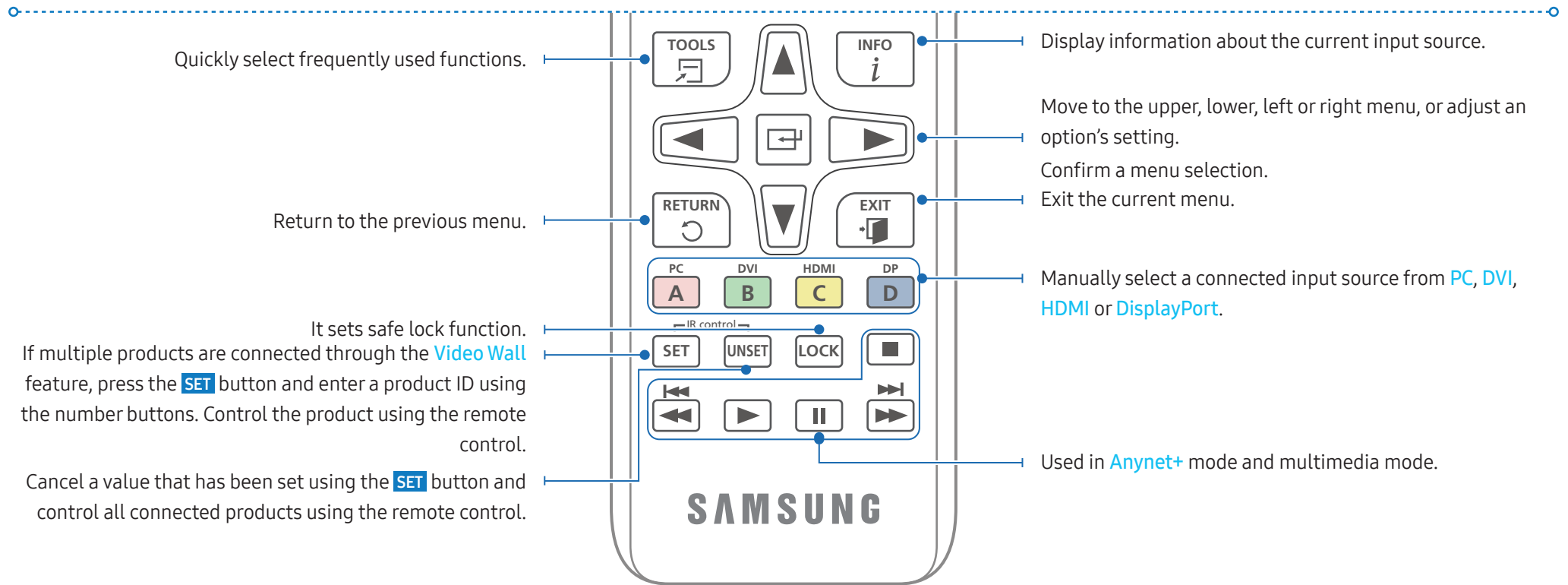

To place batteries in the remote control

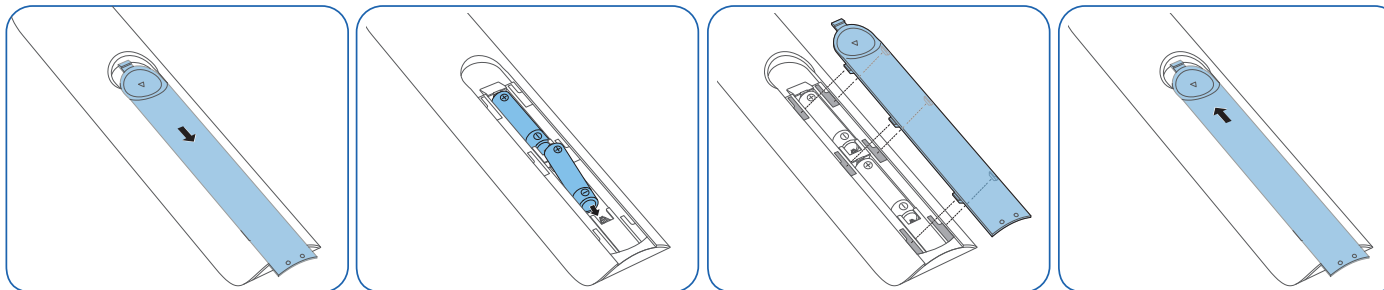

## Guided installation

### WARNING

To prevent injury, this apparatus must be securely attached to the floor/wall in accordance with the installation instructions.

- Ensure that an authorized installation company installs the wall mount. Otherwise, it may fall and cause personal injury.
- Make sure to install the specified wall mount.
- Contact Samsung Customer Service Center for further details.

## Ventilation

### Installation on a perpendicular wall

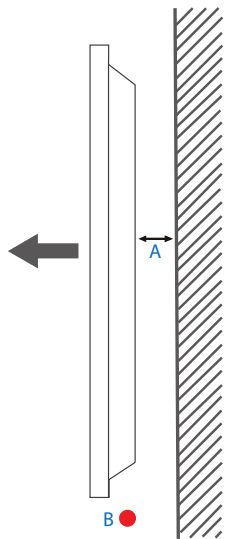

Side view

- A** Minimum 1.6 inches
- B** Ambient temperature: Under 95 °F

When installing the product on a perpendicular wall, allow at least 40 mm of space between the product and wall surface for ventilation and ensure that the ambient temperature is kept below 95 °F.

### Installation on an indented wall

Contact Samsung Customer Service Center for further details.

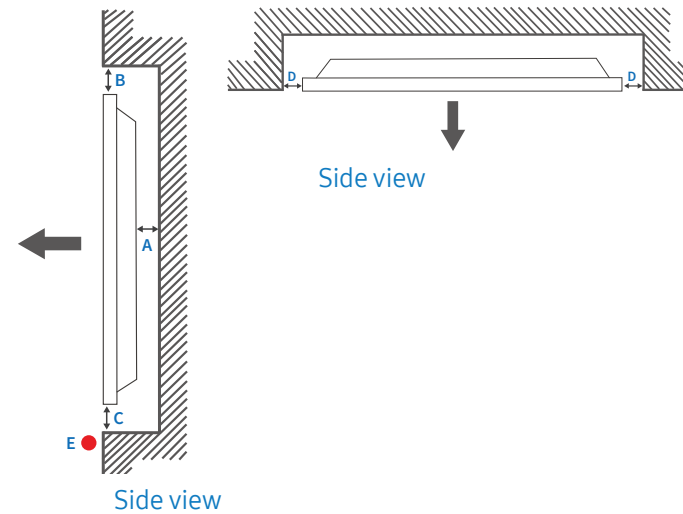

- A** Minimum 1.6 inches
- B** Minimum 2.8 inches
- C** Minimum 2 inches
- D** Minimum 2 inches
- E** Ambient temperature: Under 95 °F

When installing the product on an indented wall, allow at least the space specified above between the product and wall for ventilation and ensure that the ambient temperature is kept below 95 °F.



## Wall mount installation

### Preparing before installing wall mount

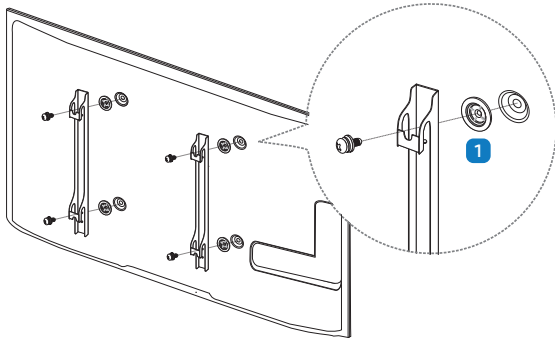

To install a wall mount from another manufacturer, use the **Holder-Ring (1)**.

### Installing the wall mount

- The wall mount kit (sold separately) allows you to mount the product on the wall.
- For detailed information on installing the wall mount, see the instructions provided with the wall mount.
- We recommend you contact a technician for assistance when installing the wall mount bracket.

#### **WARNING**

- Samsung Electronics is not responsible for any damage to the product or injury to yourself or others if you elect to install the wall mount on your own.

### Wall mount kit specifications (VESA)

Install your wall mount on a solid wall perpendicular to the floor. Before attaching the wall mount to surfaces other than plaster board, please contact your nearest dealer for additional information.

#### **WARNING**

If you install the product on a slanted wall, it may fall and result in severe personal injury.

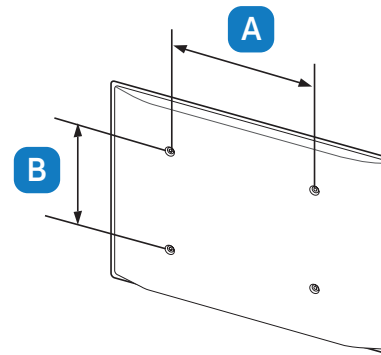

- Samsung wall mount kits contain a detailed installation manual and all parts necessary for assembly are provided.
- For wall mounts that do not comply with the VESA standard screw specifications, the length of the screws may differ depending on the wall mount specifications.
- Standard dimensions for wall mount kits are shown in the table below.

Unit: inch

Model name	VESA screw hole specs (A * B) in inches	Standard screw	Quantity
PM32F	7.9 inches * 7.9 inches	M8	4
PM43F/PH43F			
PM49F/PH49F	15.8 inches * 15.8 inches		
PM55F/PH55F			

**WARNING**

- Do not fasten the screws too firmly. This may damage the product or cause the product to fall, leading to personal injury. Samsung is not liable for these kinds of accidents.
- Samsung is not liable for product damage or personal injury when a non-VESA or non-specified wall mount is used or the consumer fails to follow the product installation instructions.

**CAUTION**

- Always have two people mount the product on a wall.
- Do not use screws that are longer than the standard length or do not comply with the VESA standard screw specifications. Screws that are too long may cause damage to the inside of the product.
- Do not install your Wall Mount Kit while your product is turned on. It may result in personal injury due to electric shock.

## External connection

### Checkpoints

- Before connecting a source device, read the user manual provided with it. The number and locations of ports on source devices may differ from device to device.
- Connect the sound ports correctly: left = white and right = red.
- Check the types of ports at the back of the product you want to connect.

The appearance may differ depending on the product.

**WARNING**

Do not connect the power cable until all connections are completed. Connecting the power cable during connection may damage the product.

### Cable Connection

#### RS232C Cable

Interface	RS232C (9 pins)
Pin	TxD (No.2), RxD (No.3), GND (No.5)
Bit rate	9600 bps
Data bits	8 bit
Parity	None
Stop bit	1 bit
Flow control	None
Maximum length	50 ft (only shielded type)

Pin assignment

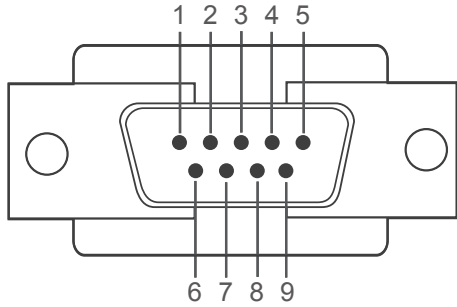

Pin	Signal
1	Detect data carrier
2	Received data
3	Transmitted data
4	Prepare data terminal
5	Signal ground
6	Prepare data set
7	Send request
8	Clear to send
9	Ring indicator

RS232C cable

- Connector: 9-Pin D-Sub to Stereo Cable

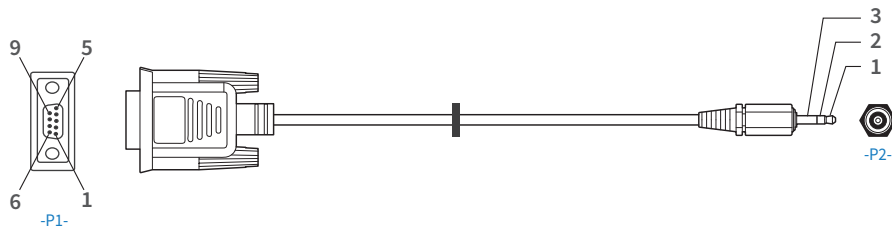

-P1-		-P1-		-P2-		-P2-
Female	Rx	2	→	3	Tx	STEREO
	Tx	3	←	2	Rx	PLUG
	Gnd	5	—	5	Gnd	(3.5ø)

LAN Cable

Pin assignment

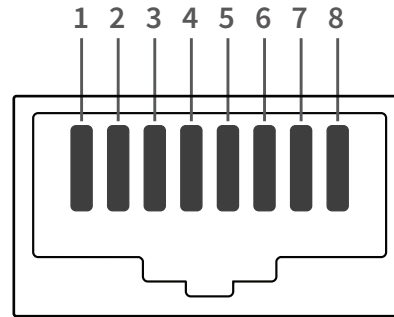

Pin No	Standard Color	Signal
1	White and orange	TX+
2	Orange	TX-
3	White and green	RX+
4	Blue	NC
5	White and blue	NC
6	Green	RX-
7	White and brown	NC
8	Brown	NC

### Direct LAN cable (PC to HUB)

- Connector : RJ45

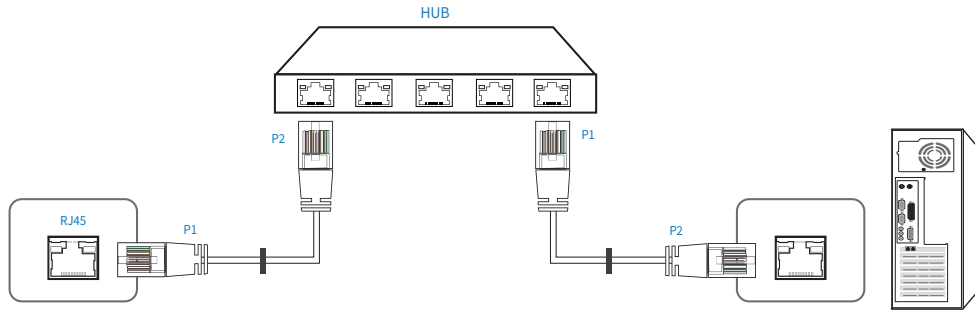

Signal	P1		P2	Signal
TX+	1	↔	1	TX+
TX-	2	↔	2	TX-
RX+	3	↔	3	RX+
RX-	6	↔	6	RX-

### Cross LAN cable (PC to PC)

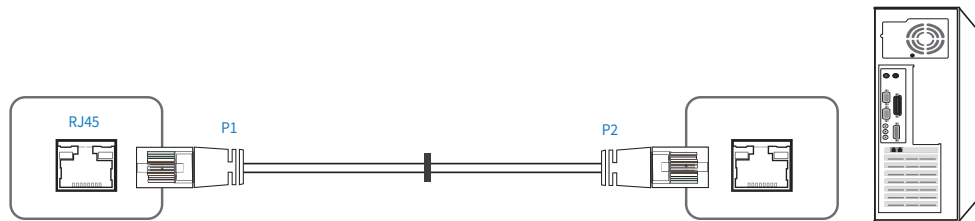

Signal	P1		P2	Signal
TX+	1	↔	3	RX+
TX-	2	↔	6	RX-
RX+	3	↔	1	TX+
RX-	6	↔	2	TX-

### Connection

- Ensure you connect each of the adapters to the correct RS232C IN or OUT port on the product.

#### Connection 1

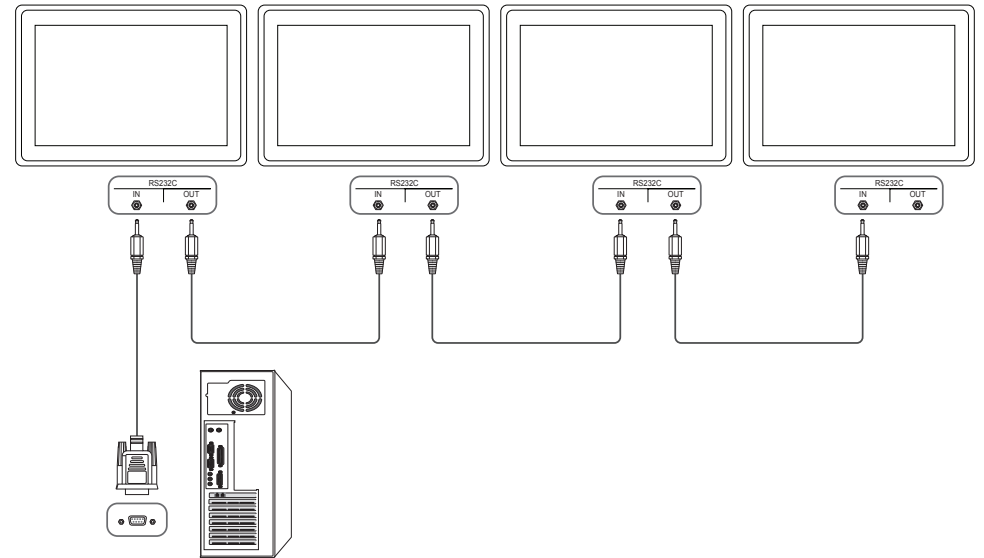

#### Connection 2

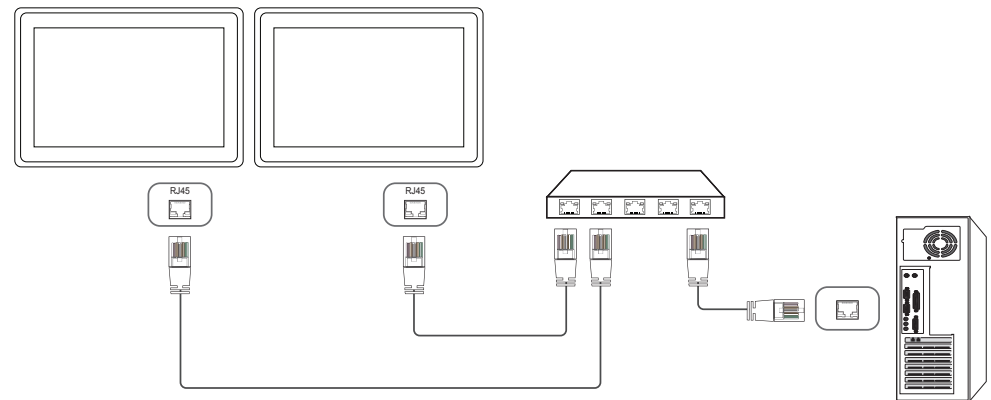

### Connection 3

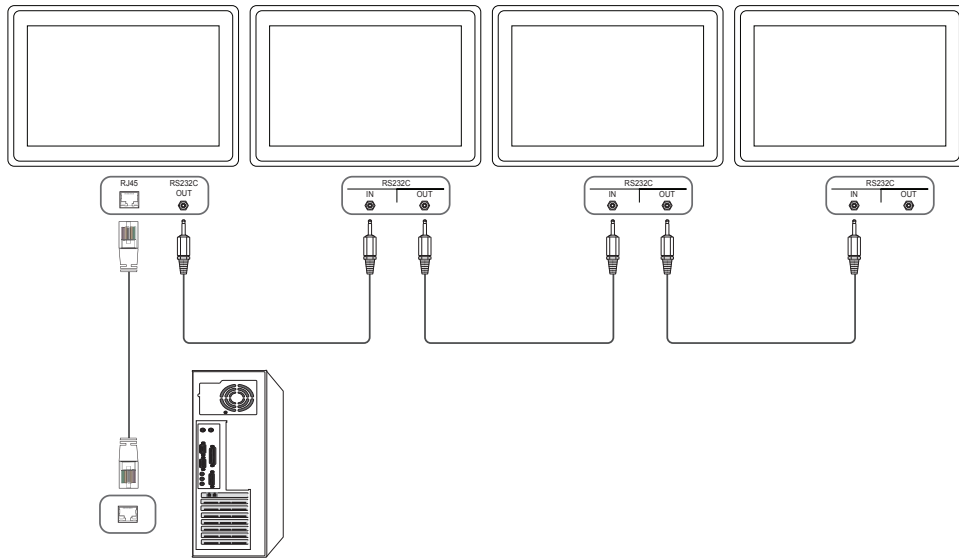

### Control Codes

#### Viewing control state (Get control command)

Header	Command	ID	Data length	Checksum
0xAA	Command type		0	

#### Controlling (Set control command)

Header	Command	ID	Data length	Data	Checksum
0xAA	Command type		1	Value	

### Command

No.	Command type	Command	Value range
1	Power control	0x11	0~1
2	Volume control	0x12	0~100
3	Input source control	0x14	-
4	Screen mode control	0x18	-
5	Screen size control	0x19	0~255
6	PIP on/off control	0x3C	0~1
7	Auto adjustment control (PC and BNC only)	0x3D	0
8	Video wall mode control	0x5C	0~1
9	Safety Lock	0x5D	0~1
10	Video Wall On	0x84	0~1
11	Video Wall User Control	0x89	-

- All communications take place in hexadecimals. The checksum is calculated by adding up all values except the header. If a checksum adds up to be more than 2 digits as shown below (11+FF+01+01=112), the first digit is removed.

**E.g. Power On & ID=0**

Header	Command	ID	Data length	Data 1	Checksum
0xAA	0x11		1	"Power"	

Header	Command	ID	Data length	Data 1	12
0xAA	0x11		1	1	

- To control all devices connected by a serial cable simultaneously irrespective of IDs, set the ID as "0xFE" and transmit commands. Commands will be executed by each device but ACK will not respond.

**Power control****Function**

- A product can be powered on and off using a PC.

**Viewing power state (Get Power ON / OFF Status)**

Header	Command	ID	Data length	Checksum
0xAA	0x11		0	

**Setting power ON/Off (Set Power ON / OFF)**

Header	Command	ID	Data length	Data	Checksum
0xAA	0x11		1	"Power"	

"Power": Power code to be set on a product.

- 1: Power ON
- 0: Power OFF

**Ack**

Header	Command	ID	Data length	Ack/ Nak	r-CMD	Val1	Checksum
0xAA	0xFF		3	'A'	0x11	"Power"	

"Power": Power code to be set on a product.

**Nak**

Header	Command	ID	Data length	Ack/ Nak	r-CMD	Val1	Checksum
0xAA	0xFF		3	'N'	0x11	"ERR"	

"ERR": A code showing what error has occurred.

**Volume control****Function**

- The volume of a product can be adjusted using a PC.

**Viewing volume state (Get Volume Status)**

Header	Command	ID	Data length	Checksum
0xAA	0x12		0	

**Setting the volume (Set Volume)**

Header	Command	ID	Data length	Data	Checksum
0xAA	0x12		1	"Volume"	

"Volume": Volume value code to be set on a product. (0-100)

**Ack**

Header	Command	ID	Data length	Ack/ Nak	r-CMD	Val1	Checksum
0xAA	0xFF		3	'A'	0x12	"Volume"	

"Volume": Volume value code to be set on a product. (0-100)

**Nak**

Header	Command	ID	Data length	Ack/ Nak	r-CMD	Val1	Checksum
0xAA	0xFF		3	'N'	0x12	"ERR"	

"ERR" : A code showing what error has occurred.

**Input source control****Function**

- The input source of a product can be changed using a PC.

**Viewing input source state (Get Input Source Status)**

Header	Command	ID	Data length	Checksum
0xAA	0x14		0	

**Setting the input source (Set Input Source)**

Header	Command	ID	Data length	Data	Checksum
0xAA	0x14		1	"Input Source"	

"Input Source": An input source code to be set on a product.

0x14	PC
0x18	DVI
0x0C	Input source
0x08	Component
0x20	MagicInfo
0x1F	DVI_video
0x30	RF(TV)
0x40	DTV
0x21	HDMI1
0x22	HDMI1_PC
0x23	HDMI2
0x24	HDMI2_PC
0x25	DisplayPort

DVI\_video, HDMI1\_PC and HDMI2\_PC cannot be used with the Set command. They only respond to "Get" commands.

- This model does not support HDMI1, HDMI1\_PC, HDMI2 and HDMI2\_PC ports.
- MagicInfo** is only available with models that contain the **MagicInfo** function.
- RF(TV), DTV are only available with models that include a TV.

**Ack**

Header	Command	ID	Data length	Ack/ Nak	r-CMD	Val1	Checksum
0xAA	0xFF		3	'A'	0x14	"Input Source"	

"Input Source": An input source code to be set on a product.

**Nak**

Header	Command	ID	Data length	Ack/ Nak	r-CMD	Val1	Checksum
0xAA	0xFF		3	'N'	0x14	"ERR"	

"ERR": A code showing what error has occurred.

**Screen mode control****Function**

- The screen mode of a product can be changed using a PC.
- Screen mode cannot be controlled when the [Video Wall](#) function is enabled.
- This control can only be used on models that include a TV.

**Viewing screen status (Get Screen Mode Status)**

Header	Command	ID	Data length	Checksum
0xAA	0x18		0	

**Setting the picture size (Set Picture Size)**

Header	Command	ID	Data length	Data	Checksum
0xAA	0x18		1	"Screen Mode"	

"Screen Mode": A code that sets the product status

0x01	16 : 9
0x04	Zoom
0x31	Wide Zoom
0x0B	4 : 3

**Ack**

Header	Command	ID	Data length	Ack/ Nak	r-CMD	Val1	Checksum
0xAA	0xFF		3	'A'	0x18	"Screen Mode"	

"Screen Mode": A code that sets the product status

**Nak**

Header	Command	ID	Data length	Ack/ Nak	r-CMD	Val1	Checksum
0xAA	0xFF		3	'N'	0x18	"ERR"	

"ERR": A code showing what error has occurred.

**Screen size control****Function**

- The screen size of a product can be changed using a PC.

**Viewing the screen size (Get Screen Size Status)**

Header	Command	ID	Data length	Checksum
0xAA	0x19		0	



**Ack**

Header	Command	ID	Data length	Ack/ Nak	r-CMD	Val1	Checksum
0xAA	0xFF		3	'A'	0x19	"Screen Size"	

"Screen Size": product screen size (range: 0 – 255, unit: inch)

**Nak**

Header	Command	ID	Data length	Ack/ Nak	r-CMD	Val1	Checksum
0xAA	0xFF		3	'N'	0x19	"ERR"	

"ERR": A code showing what error has occurred.

**PIP On/Off control****Function**

- The PIP mode of a product can be turned on or off using a PC.
- Only available on models that have the PIP function.
- The mode cannot be controlled if [Video Wall](#) is set to **On**.
- This function is not available in [MagicInfo](#).

**Viewing PIP on/off state (Get the PIP ON / OFF Status)**

Header	Command	ID	Data length	Checksum
0xAA	0x3C		0	

**Setting PIP on/off (Set the PIP ON / OFF)**

Header	Command	ID	Data length	Data	Checksum
0xAA	0x3C		1	"PIP"	

"PIP": A code used to turn the PIP mode of a product on or off

- 1: PIP ON
- 0: PIP OFF

**Ack**

Header	Command	ID	Data length	Ack/ Nak	r-CMD	Val1	Checksum
0xAA	0xFF		3	'A'	0x3C	"PIP"	

"PIP": A code used to turn the PIP mode of a product on or off

**Nak**

Header	Command	ID	Data length	Ack/ Nak	r-CMD	Val1	Checksum
0xAA	0xFF		3	'N'	0x3C	"ERR"	

"ERR": A code showing what error has occurred.

**Auto adjustment control (PC and BNC only)****Function**

- Automatically adjust the PC system screen using a PC.

**Viewing auto adjustment state (Get Auto Adjustment Status)**

- None

### Setting auto adjustment (Set Auto Adjustment)

Header	Command	ID	Data length	Data	Checksum
0xAA	0x3D		1	"Auto Adjustment"	

"Auto Adjustment": 0x00 (at all times)

#### Ack

Header	Command	ID	Data length	Ack/ Nak	r-CMD	Val1	Checksum
0xAA	0xFF		3	'A'	0x3D	"Auto Adjustment"	

#### Nak

Header	Command	ID	Data length	Ack/ Nak	r-CMD	Val1	Checksum
0xAA	0xFF		3	'N'	0x3D	"ERR"	

"ERR": A code showing what error has occurred.

## Video Wall Mode Control

### Function

- **Video Wall** mode can be activated on a product using a PC.
- This control is only available on a product whose **Video Wall** is enabled.

### Viewing video wall mode (Get Video Wall Mode)

Header	Command	ID	Data length	Checksum
0xAA	0x5C		0	

### Setting the video wall (Set Video Wall Mode)

Header	Command	ID	Data length	Data	Checksum
0xAA	0x5C		1	"Video Wall Mode"	

"Video Wall Mode": A code used to activate Video Wall mode on a product

- 1: **Full**
- 0: **Natural**

#### Ack

Header	Command	ID	Data length	Ack/ Nak	r-CMD	Val1	Checksum
0xAA	0xFF		3	'A'	0x5C	"Video Wall Mode"	

"Video Wall Mode": A code used to activate Video Wall mode on a product

#### Nak

Header	Command	ID	Data length	Ack/ Nak	r-CMD	Val1	Checksum
0xAA	0xFF		3	'N'	0x5C	"ERR"	

"ERR": A code showing what error has occurred.

## Safety Lock

### Function

- PC can be used to turn the **Safety Lock** function on or off on a product.
- This control is available regardless of whether or not the power is turned on.

### Viewing the safety lock state (Get Safety Lock Status)

Header	Command	ID	Data length	Checksum
0xAA	0x5D		0	

### Enabling or disabling safety lock (Set Safety Lock Enable / Disable)

Header	Command	ID	Data length	Data	Checksum
0xAA	0x5D		1	"Safety Lock"	

"Safety Lock": Safety lock code to be set on a product

- 1: ON
- 0: OFF

### Ack

Header	Command	ID	Data length	Data	Ack/ Nak	r-CMD	Val1	Checksum
0xAA	0xFF		3	'A'		0x5D	"Safety Lock"	

"Safety Lock": Safety lock code to be set on a product

### Nak

Header	Command	ID	Data length	Data	Ack/ Nak	r-CMD	Val1	Checksum
0xAA	0xFF		3	'N'		0x5D	"ERR"	

"ERR" : A code showing what error has occurred.

## Video Wall On

### Function

- Turn Video Wall on or off on the product from your computer.

### Get Video Wall On/Off Status

Header	Command	ID	Data length	Checksum
0xAA	0x84		0	

### Set Video Wall On/Off

Header	Command	ID	Data length	Data	Checksum
0xAA	0x84		1	V.Wall_On	

V.Wall\_On: Video Wall code to be assigned to the product

- 1: Video Wall ON
- 0: Video Wall OFF

### Ack

Header	Command	ID	Data length	Data	Ack/ Nak	r-CMD	Val1	Checksum
0xAA	0xFF		3	'A'		0x84	V.Wall_On	

V.Wall\_On : Same as above

### Nak

Header	Command	ID	Data length	Data	Ack/ Nak	r-CMD	Val1	Checksum
0xAA	0xFF		3	'N'		0x84	"ERR"	

"ERR" : A code showing what error has occurred.

### Video Wall User Control

#### Function

- Turn the Video Wall function on or off on the product from your computer.

#### Get Video Wall Status

Header	Command	ID	Data length	Checksum
0xAA	0x89		0	

#### Set Video Wall

Header	Command	ID	Data length	Val1	Val2	Checksum
0xAA	0x89	2		Wall_Div	Wall_SNo	

Wall\_Div: Video Wall Divider code assigned to the product

#### 10x10 Video Wall Model

	1	2	3	4	5	6	7	8	9	10	11	12	13	14	15
Off	0x00	0x00	0x00	0x00	0x00	0x00	0x00	0x00	0x00	0x00	0x00	0x00	0x00	0x00	0x00
1	0x11	0x12	0x13	0x14	0x15	0x16	0x17	0x18	0x19	0x1A	0x1B	0x1C	0x1D	0x1E	0x1F
2	0x21	0x22	0x23	0x24	0x25	0x26	0x27	0x28	0x29	0x2A	0x2B	0x2C	0x2D	0x2E	0x2F
3	0x31	0x32	0x33	0x34	0x35	0x36	0x37	0x38	0x39	0x3A	0x3B	0x3C	0x3D	0x3E	0x3F
4	0x41	0x42	0x43	0x44	0x45	0x46	0x47	0x48	0x49	0x4A	0x4B	0x4C	0x4D	0x4E	0x4F
5	0x51	0x52	0x53	0x54	0x55	0x56	0x57	0x58	0x59	0x5A	0x5B	0x5C	0x5D	0x5E	0x5F
6	0x61	0x62	0x63	0x64	0x65	0x66	0x67	0x68	0x69	0x6A	0x6B	0x6C	0x6D	0x6E	0x6F
7	0x71	0x72	0x73	0x74	0x75	0x76	0x77	0x78	0x79	0x7A	0x7B	0x7C	0x7D	0x7E	N/A
8	0x81	0x82	0x83	0x84	0x85	0x86	0x87	0x88	0x89	0x8A	0x8B	0x8C	N/A	N/A	N/A
9	0x91	0x92	0x93	0x94	0x95	0x96	0x97	0x98	0x99	0x9A	0x9B	N/A	N/A	N/A	N/A
10	0xA1	0xA2	0xA3	0xA4	0xA5	0xA6	0xA7	0xA8	0xA9	0xAA	N/A	N/A	N/A	N/A	N/A
11	0xB1	0xB2	0xB3	0xB4	0xB5	0xB6	0xB7	0xB8	0xB9	N/A	N/A	N/A	N/A	N/A	N/A

	1	2	3	4	5	6	7	8	9	10	11	12	13	14	15
12	0xC1	0xC2	0xC3	0xC4	0xC5	0xC6	0xC7	0xC8	N/A	N/A	N/A	N/A	N/A	N/A	N/A
13	0xD1	0xD2	0xD3	0xD4	0xD5	0xD6	0xD7	N/A	N/A	N/A	N/A	N/A	N/A	N/A	N/A
14	0xE1	0xE2	0xE3	0xE4	0xE5	0xE6	0xE7	N/A	N/A	N/A	N/A	N/A	N/A	N/A	N/A
15	0xF1	0xF2	0xF3	0xF4	0xF5	0xF6	N/A	N/A	N/A	N/A	N/A	N/A	N/A	N/A	N/A

- Wall\_SNo: Product Number code assigned to the product

#### 10x10 Video Wall Model : (1 ~ 100)

Set Number	Data
1	0x01
2	0x02
...	...
99	0x63
100	0x64

#### Ack

Header	Command	ID	Data length	Ack/ Nak	r-CMD	Val1	Val2	Checksum
0xAA	0xFF		3	'A'	0x89	Wall_Div	Wall_SNo	

#### Nak

Header	Command	ID	Data length	Ack/ Nak	r-CMD	Val1	Checksum
0xAA	0xFF		3	'N'	0x89	"ERR"	

"ERR" : A code showing what error has occurred.

## PC connection

- Do not connect the power cable before connecting all other cables.  
Ensure you connect a source device first before connecting the power cable.
- A PC can be connected to the product in a variety of ways.  
Select a connection method suitable for your PC.
- Connecting parts may differ in different products.

### Connection using a DVI cable (Digital type)

The appearance may differ depending on the product.

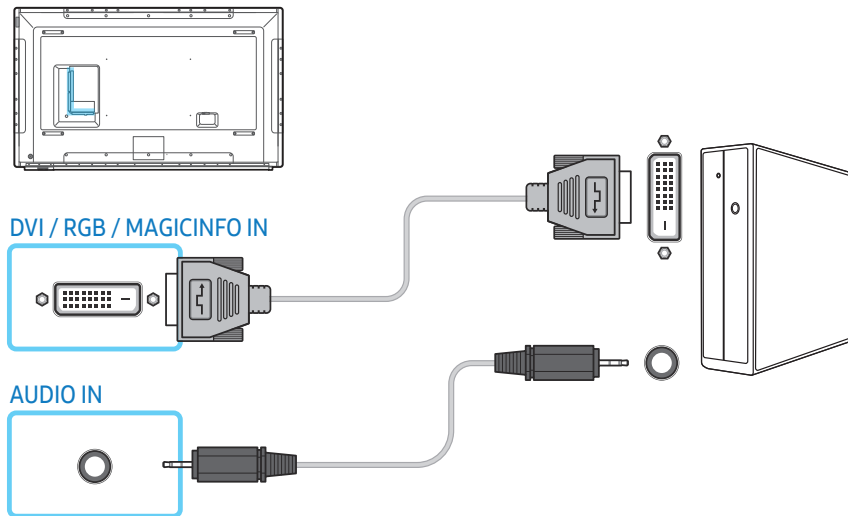

You can use the DVI port on the product as an HDMI port by using a DVI-HDMI adapter.

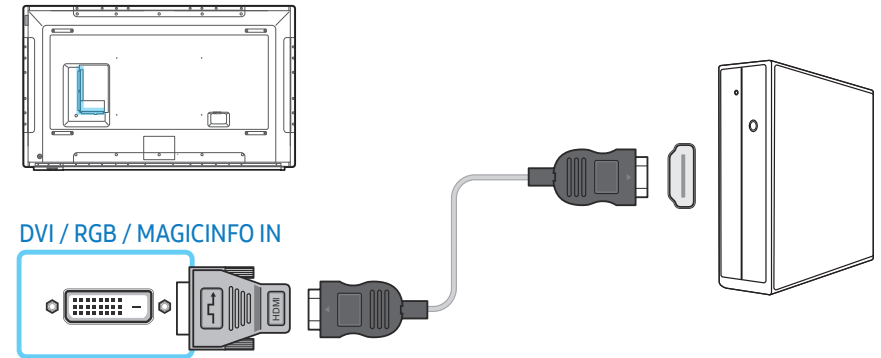

### Connection using a D-SUB cable (Analog type)

The appearance may differ depending on the product.

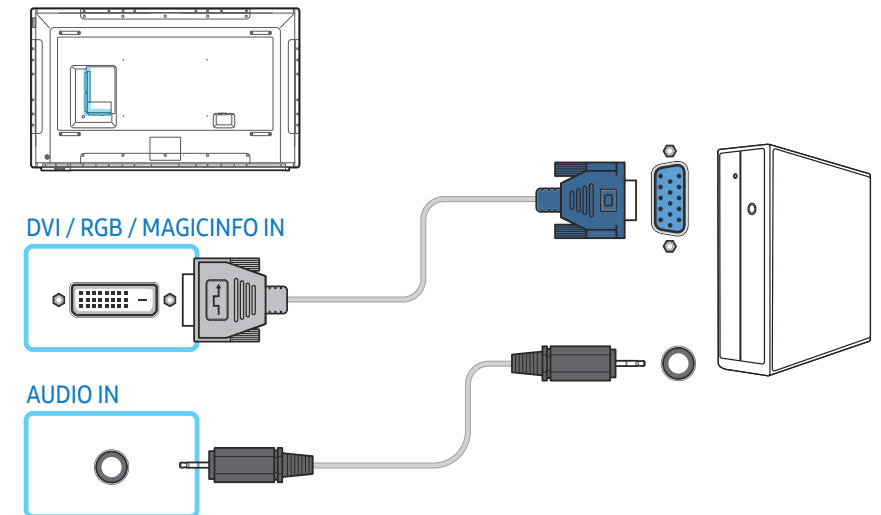

You can use the DVI port on the product as a D-SUB port by using a D-SUB-DVI adapter.

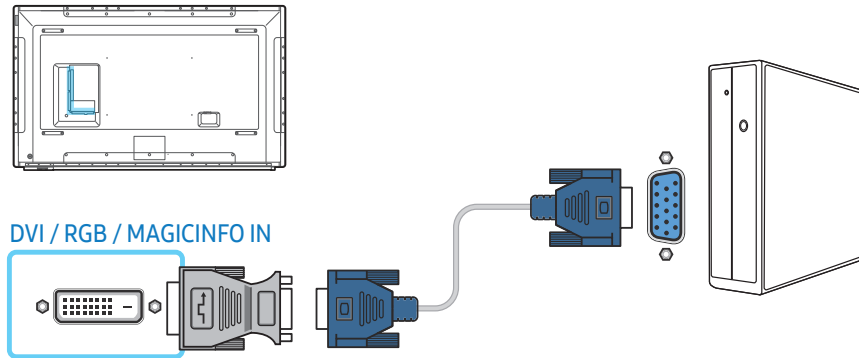

### Connection using an HDMI-DVI cable

The appearance may differ depending on the product.

After connecting a computer to the product with an HDMI-DVI cable, make sure to configure the settings as shown below to enable the video and audio from the computer.

- **Sound** → set **HDMI Sound** to **PC(DVI)**
- **Picture** → set each screen mode to **Text** under **Picture Mode**
- **System** → **General** → set **HDMI Hot Plug** to **Off**

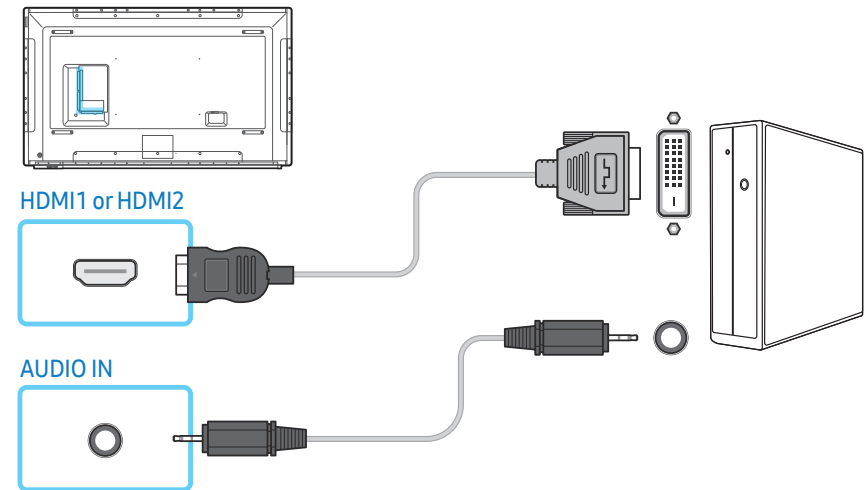

## Connection using an HDMI cable

The appearance may differ depending on the product.

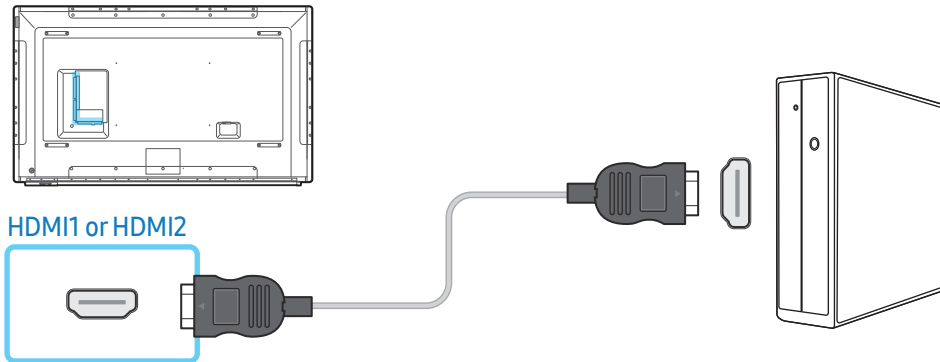

## Connection using an DP cable

The appearance may differ depending on the product.

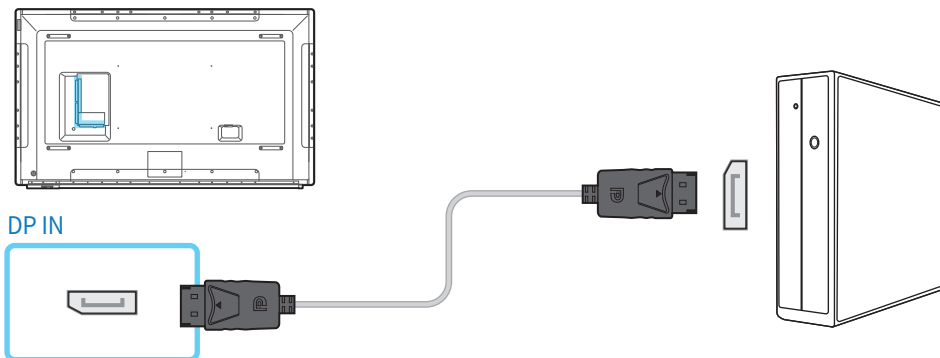

## Precautions for using DP

- To increase the standby power capacity, the product stops DP communication when it is turned off or in power saving mode.  
If the product in dual monitor mode is turned off or goes into power saving mode, monitor setting changes may not be updated. As a result, screen output may not be displayed properly.  
In the occurrence of this issue, set **Max. Power Saving** to **Off** before using the product.
- Some graphics cards that are not compliant with the DP standard may prevent the Windows Booting/Bios screen from being displayed when the product is in power saving mode. If this is the case, make sure to turn on the product first before turning on your PC.
- The DisplayPort interface (**DP IN**) on the product and the provided DP cable are designed based on the VESA standards. Using a DP cable that is not VESA compliant may cause the product to function improperly. Samsung Electronics shall not be held responsible for any issues from using a cable that is not VESA compliant. Make sure to use a DP cable that is VESA compliant.

## AV connection

- Do not connect the power cable before connecting all other cables.  
Ensure you connect a source device first before connecting the power cable.
- You can connect a video device to the product using a cable.
  - Connecting parts may differ in different products.
  - Press the **SOURCE** button on the remote control to change the source.

### Connection using an HDMI-DVI cable

The appearance may differ depending on the product.

- Audio will not be enabled if the product is connected to a video device using an HDMI-DVI cable. To resolve this, additionally connect an audio cable to the audio ports on the product and video device.
- After connecting a video device to the product with an HDMI-DVI cable, make sure to configure the settings as shown below to enable the video and audio from the video device.
  - **Sound** → set **HDMI Sound** to **AV(HDMI)**
  - **Picture** → set each screen mode to **Videos/Images** under **Picture Mode**
  - **System** → **General** → set **HDMI Hot Plug** to **On**

- Supported resolutions include 1080p (50/60Hz), 720p (50/60Hz), 480p, and 576p.

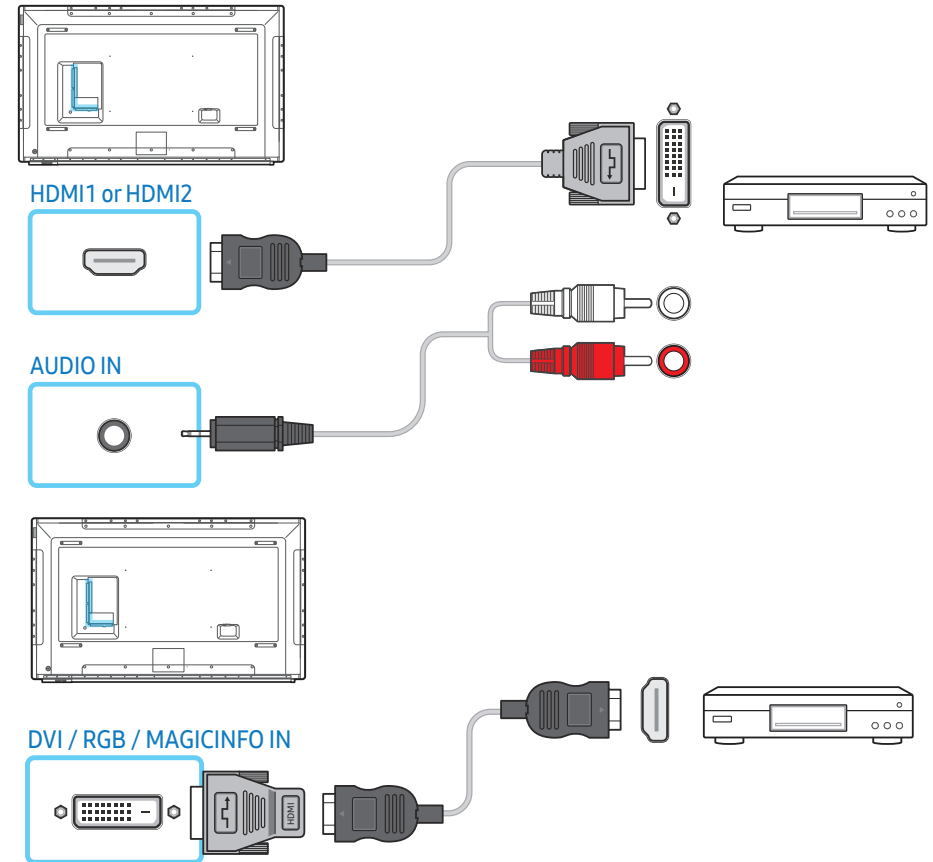



## Connection using an HDMI cable (up to 1080p)

The appearance may differ depending on the product.

- For better picture and audio quality, connect to a digital device using an HDMI cable.
- An HDMI cable supports digital video and audio signals, and does not require an audio cable.
  - To connect the product to a digital device that does not support HDMI output, use an HDMI-DVI and audio cables.
- The picture may not display normally (if at all) or the audio may not work if an external device that uses an older version of HDMI mode is connected to the product. If such a problem occurs, ask the manufacturer of the external device about the HDMI version and, if out of date, request an upgrade.
- Be sure to use an HDMI cable with a thickness of 0.6 inch or less.
- Be sure to purchase a certified HDMI cable. Otherwise, the picture may not display or a connection error may occur.
- A basic high-speed HDMI cable or one with ethernet is recommended. This product does not support the ethernet function via HDMI.

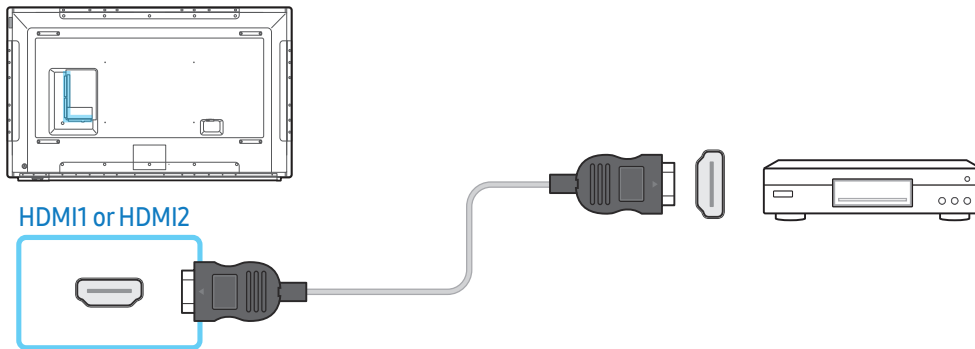

## Audio system connection

- The appearance may differ depending on the product.
- Connecting parts may differ in different products.

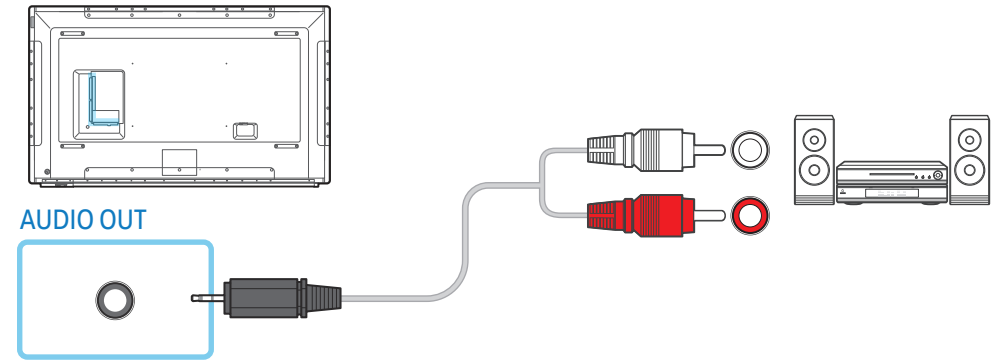

## LAN connection

- The appearance may differ depending on the product.
- Connecting parts may differ in different products.

Use Cat7(\*STP Type) cable for the connection.

- \*Shielded Twist Pair.

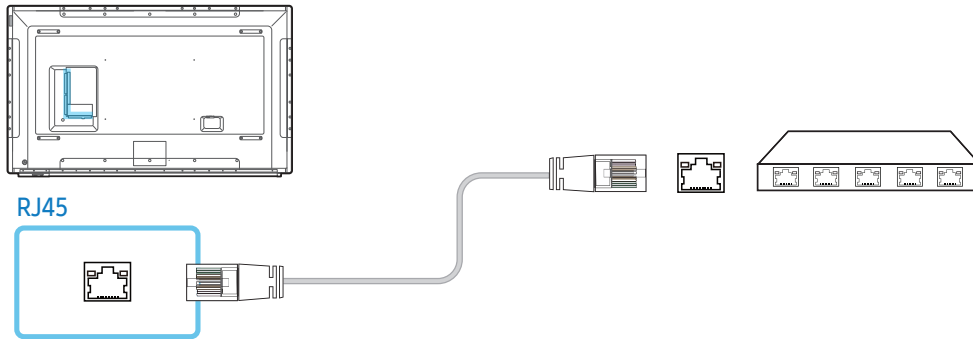

## Source selection

### Source

**SOURCE** → Source

**Source** allows you to select a variety of sources and change source device names.

You can display the screen of a source device connected to the product. Select a source from source list to display the screen of the selected source.

- The input source can also be changed by using the **SOURCE** button on the remote control.
- The screen may not display correctly if an incorrect source is selected for the source device you want to convert to.

### Edit

**SOURCE** → Source → ▲ → Edit →

Edit the name and device type of a connected external device.

- The list can include the following source devices. Source devices on the list differ depending on the selected source.

[HDMI1](#) / [HDMI2](#) / [DisplayPort](#) / [DVI](#) / [Cable Box](#) / [Game Console](#) / [PC](#) / [Blu-ray player](#)

- You cannot edit the following sources.

[TV](#) / [MagicInfo S](#) / [URL Launcher](#) / [Web Browser](#) / [Screen Mirroring](#) / [MagicInfo](#) / [PC](#)

### Information

**INFO**

You can see detailed information about the selected external device.

# PC software (Multiple Display Control)

Multiple display control “MDC” is an application that allows you to easily control multiple display devices simultaneously using a PC.

For details on how to use the MDC programme, refer to Help after installing the programme. The MDC programme is available on the website.

## Installation/uninstallation

### Installation

- MDC installation can be affected by the graphics card, mother board and network conditions.
- 1 Click the **MDC Unified** installation programme.
  - 2 Select a language for installation. Next, click **“OK”**.
  - 3 When the **“Welcome to the InstallShield Wizard for MDC\_Unified”** screen appears, click **“Next”**.
  - 4 In the **“License Agreement”** window displayed, select **“I accept the terms in the license agreement”** and click **“Next”**.
  - 5 In the displayed **“Customer Information”** window, fill out all the information fields and click **“Next”**.
  - 6 In the displayed **“Destination Folder”** window, select the directory path you want to install the programme in and click **“Next”**.
    - If the directory path is not specified, the programme will be installed in the default directory path.
  - 7 In the displayed **“Ready to Install the Program”** window, check the directory path to install the programme in and click **“Install”**.
  - 8 Installation progress will be displayed.
  - 9 Click **“Finish”** in the displayed **“InstallShield Wizard Complete”** window.

- Select **“Launch MDC Unified”** and click **“Finish”** to run the MDC programme immediately.

- 10 The MDC Unified shortcut icon will be created on the desktop after installation.
  - The MDC execution icon may not be displayed depending on the PC system or product specifications.
  - Press F5 if the execution icon is not displayed.

### Uninstallation

- 1 Go to **Control Panel**.
- 2 Under **Programs**, click **Uninstall a program**.
- 3 Select **MDC Unified** from the list.
- 4 Click **Uninstall/Change**.

Path and name of the menu may differ depending on the operating system.

## Connection

### Using the RS-232C cable

The appearance may differ depending on the product.

An RS-232C serial cable must be connected to the serial ports on the PC and monitor.

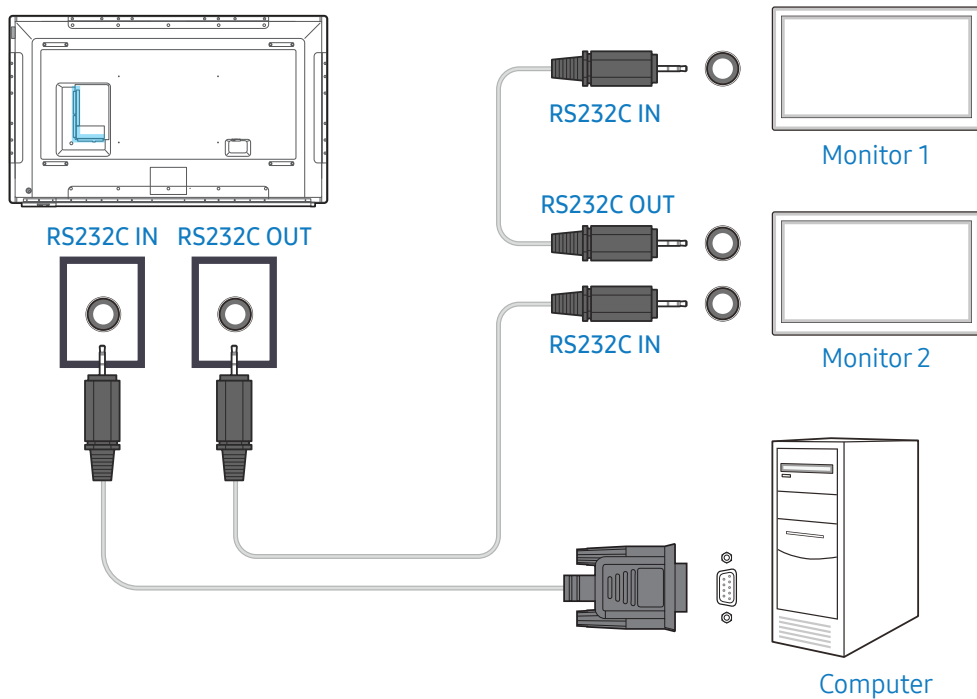

### Using the ethernet cable

Enter the IP for the primary display device and connect the device to the PC. Display devices can be connected to each other using a LAN cable.

#### Connection using a direct LAN cable

The appearance may differ depending on the product.

Multiple products can be connected using the RJ45 port on the product and the LAN ports on the HUB.

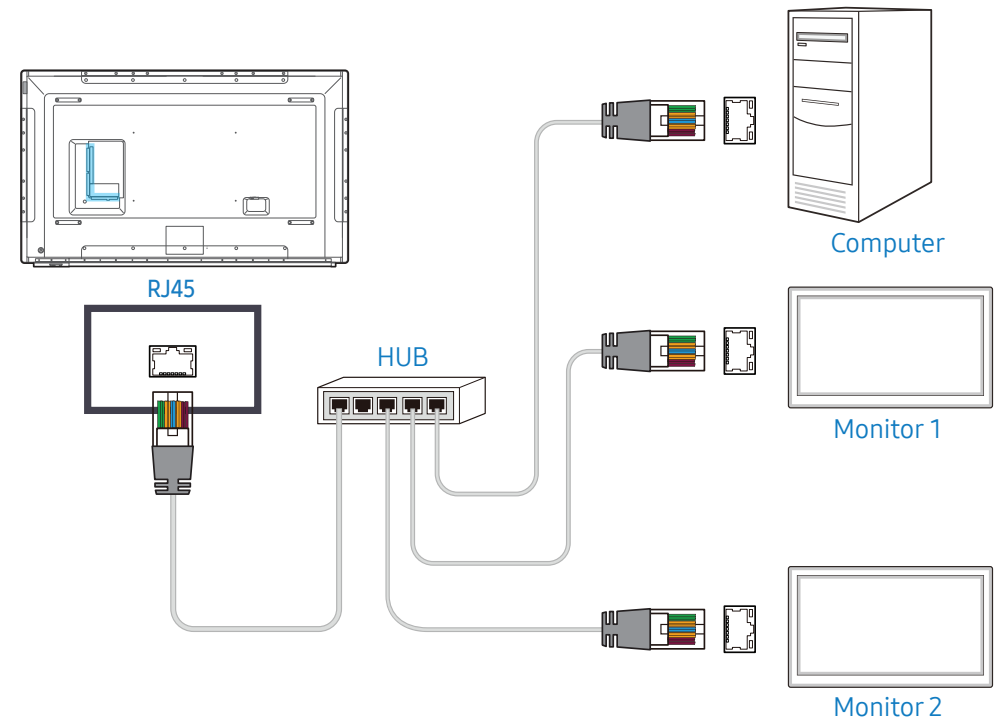

### Connection using a cross LAN cable

The appearance may differ depending on the product.

Multiple products can be connected using the RS232C IN / OUT port on the product.

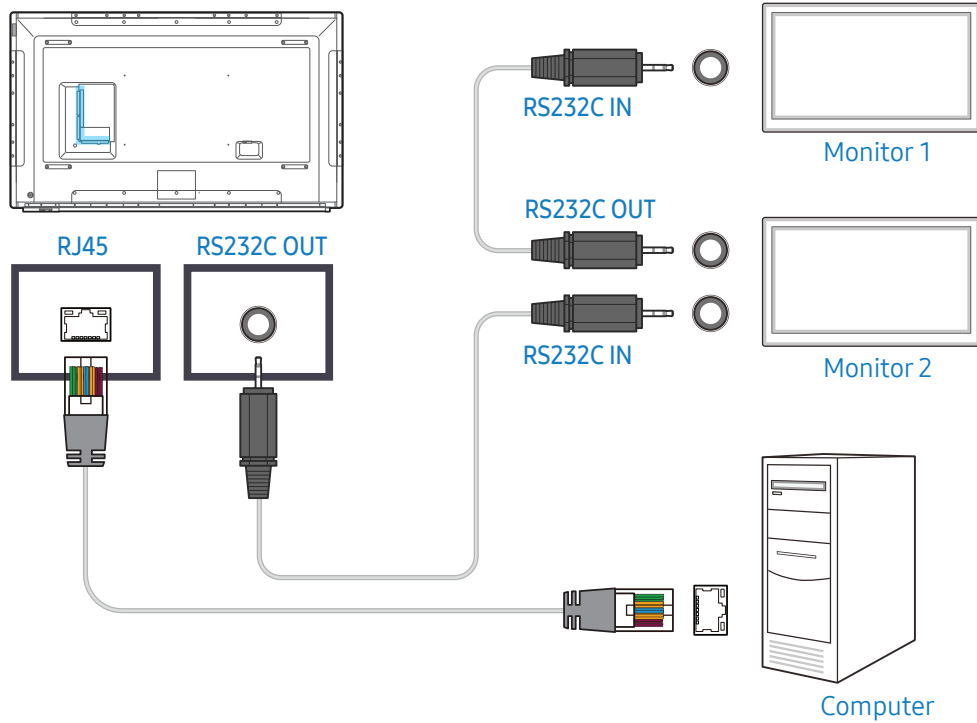

# Home screen

## Player

HOME → Player → 

Play a range of content such as channels with schedules assigned, templates or files.

- To use the **Player** feature, set **Play via** to **MagicInfo** in **System**.
- The displayed image may differ depending on the model.

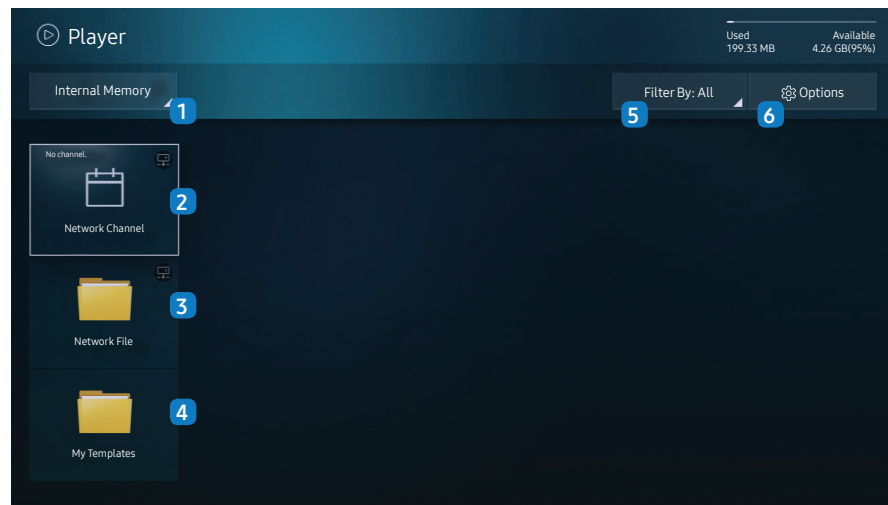

No.	Description
1	Select between internal or external memory.

No.	Description
2	Play content, templates and schedules configured on the server. <ul style="list-style-type: none"> <li>• You can view whether the server is connected (approval) in the <b>Player</b> screen. To view whether the server is connected when a Network Channel is running, press <b>INFO</b> on the remote.</li> </ul> <ol style="list-style-type: none"> <li>1 Select <b>Network Channel</b> from the <b>Player</b> screen. The <b>No channel</b> message appears if no channel has been registered in <b>Network Channel</b>.</li> <li>2 <b>Network Channel</b> will run.</li> </ol>
3	Play content stored on the server.
4	Play a template stored in the internal memory.
5	Select a content type as criterion to search for a desired content list.
6	Set different options for <b>Player</b> .









## Viewing content

- 1 Select either internal or external memory. The files saved in the selected memory appear.
- 2 Select the desired file. The content appears on the screen.  
(For more information on compatible file formats, see the “File formats compatible with Player” section.)

## When content is running

### Control buttons on the remote

You can use buttons on your remote control to play, pause, or skip between content on the playlist.

Button	Function
	Brings up the menu bar.
	Displays the information of the content.
	Goes to next file or page.
	Goes to previous file or page.
	Plays or pauses slide show or video content.
	Stops displaying content and goes to the Player screen.
	Rewinds the video content.
	Fast forwards the video content.

### Available menu

Press the **TOOLS** button on the remote control during content playback to configure settings.

Menu	Description
<b>Playlist</b>	View a list of content items currently playing.
<b>Picture Mode</b>	Customises the screen settings for the content currently playing.
<b>Sound Mode</b>	Customises the audio settings for the content currently playing.
<b>Repeat</b>	Set the repeat mode.

Menu	Description
<b>Background Music</b>	Set the background music to be played when content is running.
<b>Reset</b>	Reset the background music.
<b>Pause</b>	Pause the background music.
<b>Prev</b>	Play the previous background music on the list.
<b>Next</b>	Play the next background music on the list.

**Reset, Pause, Prev, Next** only appear when the background music is set.

## File formats compatible with Player

- Supported file systems include FAT32 and NTFS.
- A file with a vertical and horizontal resolution larger than the maximum resolution cannot be played.
- Check the vertical and horizontal resolution of the file.
- Check the supported video and audio Codec types and Versions.
- Check the supported file versions.
  - PowerPoint version up to 97 – 2007 is supported
- Only the last USB device that was connected is recognized.

## Network Schedule Multiframe

### Playback restrictions

- A maximum of two video files (**Video**) can be played simultaneously.
- In portrait playback mode, only one video file can be played at a time.
- For **Office** files (PPT and Word files) and **PDF** files, only one file type is supported at a time.
- LFD(.lfd) files are not supported.

### Sound output restrictions

- More than one sound output cannot be used.

- Playback priority: network BGM > local BGM > video file in the main frame selected by the user
  - Network BGM: Settings can be configured in step 1 when creating a server schedule.
  - Local BGM: BGM settings can be configured using the tools displayed after the **TOOLS** button is pressed during **Player** playback.
  - User-selected main frame: Main frame settings can be configured in step 2 when creating a server schedule.

## Template files and LFD(.lfd) files

### Restrictions

- Ensure a distributed folder (content / schedules) exists in **Internal** / **USB** memory.

### Playback restrictions

- A maximum of two video (**Video**) files can be played.
- For **Office** files (PPT and Word files) and **PDF** files, only one file type is supported at a time.
- Multiple videos (Video) cannot be played on a single display of a video wall simultaneously.

### Sound output restrictions

- More than one sound output cannot be used.
- Playback priority: network BGM > local BGM > video file in the main frame selected by the user



## Contents

File extension	Container	Video Codec	Resolution	Frame rate (fps)	Bit rate (Mbps)	Audio Codec
*.avi	AVI	H.264 BP/MP/HP	4096x2160	4096X2160: 24	40	AC3
*.mkv	MKV			3840X2160: 30		LPCM
*.asf	ASF	HEVC (H.265 - Main, Main10, Main4:2:2 10 )		60	80	ADPCM(IMA, MS)
*.wmv	MP4					AAC
*.mp4	3GP	Motion JPEG		30	80	HE-AAC
*.mov	MOV	MVC	1920x1080	60	20	WMA
*.3gp	FLV	Divx 3.11 / 4 / 5 / 6				DD+
*.vro	VRO	MPEG4 SP/ASP				MPEG(MP3)
*.mpg	VOB	Window Media Video v9 (VC1)				DTS (Core , LBR)
*.mpeg	PS	MPEG2				G.711(A-Law, $\mu$ -Law)
*.ts	TS	MPEG1				
*.trp	SVAF	Microsoft MPEG-4 v1, v2, v3		30	20	
*.mov		Window Media Video v7(WMV1),v8(WMV2)				
*.flv		H 263 Sorrenson				
*.vob		VP6				
*.svi						
*.m2ts						
*.mts						
*.divx						
*.webm	WebM	VP8	1920x1080	90	20	Vorbis
		VP9	4096x2160	4096X2160: 24 3840X2160: 30	20	
*.rmvb	RMVB	RV8/9/10 (RV30/40)	1920x1080	60	20	RealAudio 6

## Video

- 3D video is not supported.
- Content with a resolution larger than the resolution specified in the table above is not supported.
- Video content with a Bit rate or Frame rate larger than the rate specified in the table above can cause choppy video during playback.
- Video content will not play, or not play correctly, if there is an error in the content or the container.
- Some USB/digital camera devices may not be compatible with the player.
- Supports up to H.264, Level 4.1
- H.264 FMO / ASO / RS, VC1 SP / MP / AP L4 and AVCHD are not supported.
- For all Video codecs except MVC, VP8, VP6:
  - Below 1280 x 720: 60 frame max
  - Above 1280 x 720: 30 frame max
- GMC 2 or higher is not supported.
- Supports only BD MVC Spec.
- Only one video file can play at a time if video files on the monitor use incompatible codecs or the resolution is 1080 x 1920.
- When a single video file is playing, Seamless mode is not supported under the following conditions:
  - Incompatible codec (MVC, VP3, MJPEG) ↔ Incompatible codec
  - Incompatible codec ↔ Compatible codec
  - The resolution is different from that of the monitor
  - The frequency is different from that of the monitor

## Audio

- Audio content with a Bit rate or Frame rate larger than the rate specified in the table above can cause choppy audio during playback.
- Audio content will not play, or not play correctly, if there is an error in the content or the container.
- Some USB/digital camera devices may not be compatible with the player.
- Supports up to WMA 10 Pro 5.1 channel. WMA lossless audio is not supported.
- QCELP, AMR NB/WB are not supported.

## Image

- Compatible image file format : JPEG, PNG, BMP
  - 32-bit, 24-bit and 8-bit BMP files are supported.
- Supported maximum resolution : 4096 x 4096
- Supported maximum file size: 20MB
- Supported image effects : 9 effects ([Fade1](#), [Fade2](#), [Blind](#), [Spiral](#), [Checker](#), [Linear](#), [Stairs](#), [Wipe](#), [Random](#))

**PowerPoint**

- Compatible document file formats
  - Extension : ppt, pptx
  - Version : Office 97 ~ Office 2007
- Functions not supported
  - Animation effect
  - 3D shapes (which will be displayed in 2D)
  - Header and footer (some subitems are not supported)
  - Word Art
  - Align
    - A group alignment error may occur.
  - Office 2007
    - SmartArt is not fully supported. 97 out of 115 subitems are supported.
  - Object insertion
  - Half-width characters
  - Letter spacing
  - Charts
  - Vertical text
    - Some subitems are not supported
  - Slide notes and handout

**PDF**

- Compatible document file formats
  - Extension : pdf
- Functions not supported
  - Content less than 1 pixel not supported because of performance degradation issue.
  - Masked Image, Tiled Image content not supported.
  - Content with Rotated Text, not supported.
  - 3D Shadow Effects not supported.
  - Some characters not supported (Special characters may be corrupted)

**WORD**

- Compatible document file formats
  - Extension : .doc, .docx
  - Version : Office 97 ~ Office 2007
- Functions not supported
  - Page background effect
  - Some paragraph styles
  - Word Art
  - Align
    - A group alignment error may occur
  - 3D shapes (which will be displayed in 2D)
  - Office 2007
    - SmartArt is not fully supported. 97 out of 115 subitems are supported.
  - Charts
  - Half-width characters
  - Letter spacing
  - Vertical text
    - Some subitems are not supported
  - Slide notes and handout

**Template files**

- Creation/editing/playback are only available in [Template](#).

**LFD**

- Supported in [Network Channel](#) and [Local Channel](#)
- Compatible document file formats
  - Extension : .lfd

## Schedule

HOME → Schedule → 

You can check the content's playback schedule on the server, imported from an external storage, or on a mobile device.

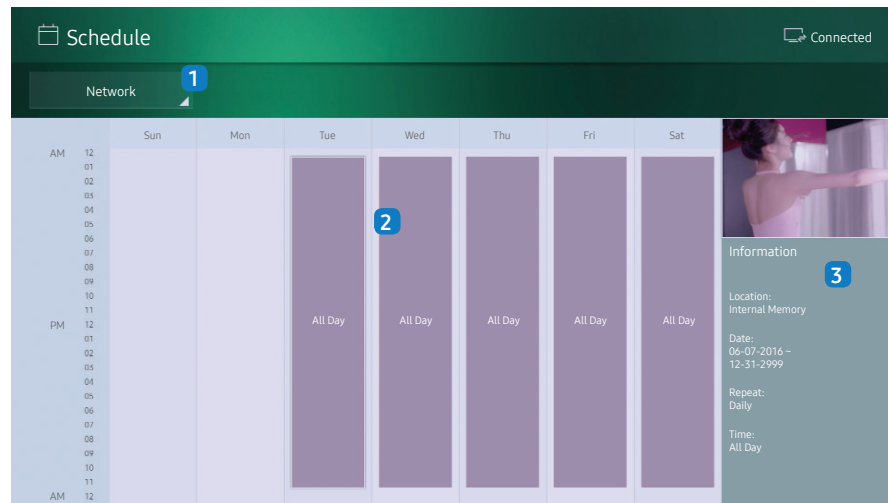

No.	Description
1	Select between server and external memory.
2	View weekly schedule of content playback. Select to view detailed information of each event.
3	View a thumbnail image and brief information of the content.

## URL Launcher

HOME → URL Launcher → 

The displayed image may differ depending on the model.

For details on how to use the [URL Launcher](#) feature, contact the dealer the product was purchased from.

- To use the [URL Launcher](#) feature, set [Play via](#) to [URL Launcher](#) in [System](#).

## URL Launcher Setting

HOME → URL Launcher Setting → 

[URL Launcher Setting](#) allows you to install/uninstall web apps, configure [Timeout Settings](#), and set [Developer Mode](#).

- [Install Web App](#): Install the web application by entering an address.
- [Install from USB Device](#): Install the web application from the USB storage device.
- [Uninstall](#): Remove the installed web application.
- [Timeout Setting](#): Set the timeout period for connecting to the URL.
- [Developer Mode](#): Select to set developer mode.

## Clone Product

HOME → Clone Product → 

Export settings on the product to an external storage device. You can also import settings from an external storage device.

This option is useful when assigning the same settings to several products.

## When a duplicate file is not found on the external storage device

- 1 Connect the external storage device, then run the [Clone Product](#) function.

- 2 The **No cloning file found on the external storage device. Export this device's settings to the external storage device?** message appears.
- 3 Select **Export** to export the settings.

## When a duplicate file is found on the external storage device

- 1 Connect the external storage device, then run the **Clone Product** function.
- 2 The **Cloning file found. Please select an option.** message appears.
- 3 Select **Clone from external storage device** or **Clone to external storage device**.
  - **Clone from external storage device:** Copy settings saved on an external storage device to the product.
  - **Clone to external storage device:** Copy settings on the product to an external storage device.

After configuration is complete, the product is rebooted automatically.

## ID Settings

---

HOME → ID Settings → 

Assign an ID to a set.

### Device ID

Enter the ID number of the product connected to the input cable for input signal reception. (Range: 0~224)

- Press ▲/▼ to select a number, and press .
- Enter the number you want using the number buttons on the remote control.

### Device ID Auto Set

This feature automatically allots an ID number to a device connected via an RS232C cable.

When multiple devices are connected, enable the feature on either the first or last device.

### PC Connection Cable

Select a method to connect to MDC to receive the MDC signal.

- **RS232C cable**  
Communicate with MDC via the RS232C-stereo cable.
- **RJ-45 (LAN) / Wi-Fi Network**  
Communicate with MDC via the RJ45 cable or Wi-Fi network.

## Video Wall

HOME → Video Wall → 

Assign an ID to a set.

Customise the layout of multiple displays that are connected to form a video wall. In addition, display part of a whole picture or repeat the same picture on each of the connected multiple displays.

To display multiple images, refer to MDC Help or the MagicInfo user manual. Some models may not support the MagicInfo function.

### Video Wall

You can activate or deactivate [Video Wall](#).

To organize a video wall, select [On](#).

### Horizontal x Vertical

This feature automatically splits a video wall display based on a video wall matrix configuration.

Enter the video wall matrix.

The video wall display is split based on the configured matrix. The number of vertical or horizontal display devices can be set within the range 1 and 15.

A video wall display can be split into a maximum of 16 screens.

The [Horizontal x Vertical](#) option is only enabled when [Video Wall](#) is set to [On](#).

### Screen Position

To rearrange split screens, adjust the number for each product in the matrix using the [Screen Position](#) feature.

Selecting [Screen Position](#) will display the video wall matrix with the numbers assigned to the products that form the video wall.

To rearrange products, use the direction buttons on the remote control to move a product to another desired number. Press the  button.

- **All Displays:** Assign screen positions to All displays. Then, you don't need to set up video wall for individual displays.
- **Current Displays:** Only Assign screen position for this first display.

[Screen Position](#) allows you to split the screen into a maximum of 16 views (15x15). The maximum number of views that can be split when products are connected via DP Loopout is also 16.

- The [Screen Position](#) option is only enabled when [Video Wall](#) is set to [On](#).
- To use the function, make sure [Horizontal x Vertical](#) is configured.

### Format

Select how to display images on the video wall display.

- **Full:** Display images in full screen with no margin.
- **Natural:** Display images in the original aspect ratio without enlarging or reducing the size.

The [Format](#) option is only enabled when [Video Wall](#) is set to [On](#).

## Network Status

HOME → Network Status → 

Check the current network and Internet connection.

## Picture Mode

HOME → Picture Mode → 

Select a picture mode (**Picture Mode**) suitable for the environment where the product will be used.

**Video/Image** mode improves the picture quality of the video device. **Text** mode improves the picture quality of the computer.

- **Shop & Mall**  
Suitable for shopping malls.
  - Select either **Video/Image** or **Text** depending on the picture mode.
- **Office & School**  
Suitable for offices and schools.
  - Select either **Video/Image** or **Text** depending on the picture mode.
- **Terminal & Station**  
Suitable for bus terminals and train stations.
  - Select either **Video/Image** or **Text** depending on the picture mode.
- **Video Wall**  
Suitable for environments where video wall display are used.
  - Select either **Video/Image** or **Text** depending on the picture mode.
- **Calibration**  
In this mode, the brightness, color and gamma settings customized using the color calibration programme **Advanced Color Management** are applied.
  - To apply the **Calibration mode** properly, make sure you configure the picture quality settings, such as brightness, color and gamma, using the color calibration programme **Advanced Color Management**.
  - To download the **Advanced Color Management** programme, visit [www.samsung.com/displaysolutions](http://www.samsung.com/displaysolutions).

## On/Off Timer

HOME → On/Off Timer → 

You must set **Clock** before you can use this feature.

### On Timer

Set **On Timer** so that your product turns on automatically at a time and on a day of your choosing.

The power is turned on with the specified volume or input source.

Set the on timer by making a selection from one of the seven options. Ensure you set the current time first. (**On Timer 1** ~ **On Timer 7**)

- **Setup**: Select **Off**, **Once**, **Everyday**, **Mon~Fri**, **Mon~Sat**, **Sat~Sun** or **Manual**.  
If you select **Manual**, you can choose the days you want **On Timer** to turn on your product.
  - The check mark indicates days you've selected.
- **Time**: Set the hour and minute. Use the number buttons or ▲/▼ buttons to enter numbers. Use ◀/▶ buttons to change entry fields.
- **Volume**: Set the desired volume level. Use the up and down arrow buttons to change the volume level.
- **Source**: Select the input source of your choice.
- **Content**: Select specific content within the internal or external memory.
- **Antenna**: Select the antenna from **Cable** or **Air**.
- **Channel**: Select the TV channel you want.

- **Content** is only available when source is set to **Internal/USB**.
- **Antenna** and **Channel** is only available for PM32F/PM43F/PM49F/PM55F models when source is set to **TV**.

- If there is no music file on the USB device or you don't select a folder containing a music file, the Timer function does not operate correctly.
- If there is only one photo file in the USB, the **Slide Show** will not play.
- If a folder name is too long, the folder cannot be selected. Up to 255 characters are recognizable.
- We recommend that you use a USB memory stick and a multi card reader when using **On Timer**.
- The **On Timer** function may not work with USB devices with a built-in battery, MP3 players, or PMPs made by some manufacturers because the product can take too long to recognize these devices.

## Off Timer

Set the off timer (**Off Timer**) by making a selection from one of the seven options. (**Off Timer 1 ~ Off Timer 7**)

- **Setup**: Select **Off**, **Once**, **Everyday**, **Mon~Fri**, **Mon~Sat**, **Sat~Sun** or **Manual**.  
If you select **Manual**, you can choose the days you want **Off Timer** to turn off your product.
  - The check mark indicates days you've selected.
- **Time**: Set the hour and minute. Use the number buttons or ▲/▼ buttons to enter numbers. Use ◀/▶ buttons to change entry fields.

## Ticker

HOME → Ticker → 

Input text while a video or image is displayed and display the text on the screen.

- **Off / On**
- **Message**: Enter a message to display on the screen.
- **Time**: Set the **Start Time** and **End Time** to display a **Message**.
- **Font options**: Set the font options for the message.
- **Position**: Select an orientation to display a **Message**.
- **Scroll**: Specify the scroll **Direction** and **Speed** for the message.
- **Preview**: Preview configured caption settings.



## Approving a connected device from the server

First configure **Server Network Settings** before device approval.



- 1 Access the server you have assigned to your device.
- 2 Enter your ID and password to log in.

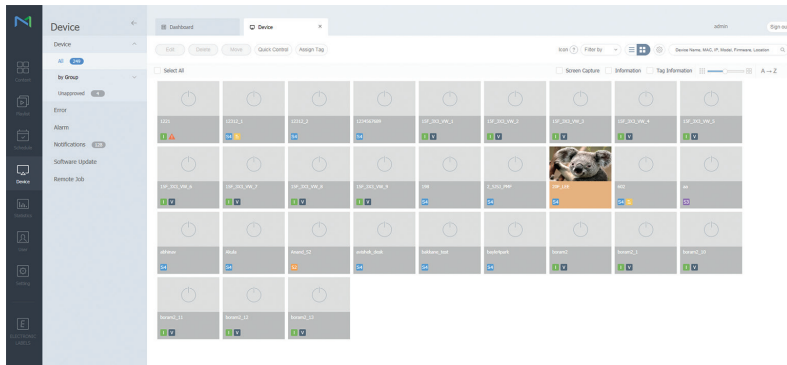

- 3 Select **Device** from the side menu bar.

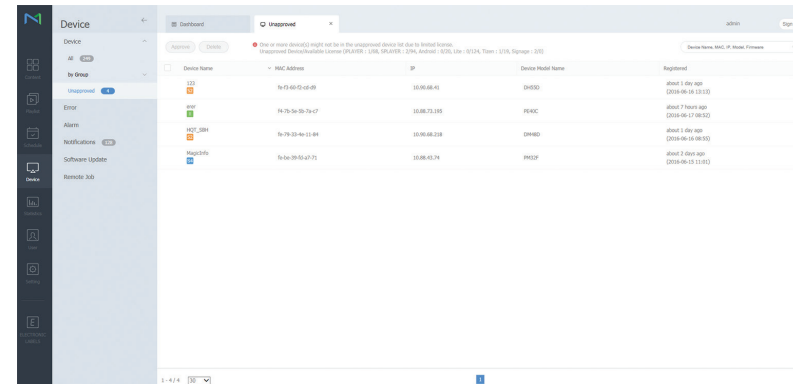

- 4 Select **Unapproved** from the sub-menus.
- 5 Select the device from the list and click the **Approve** button.

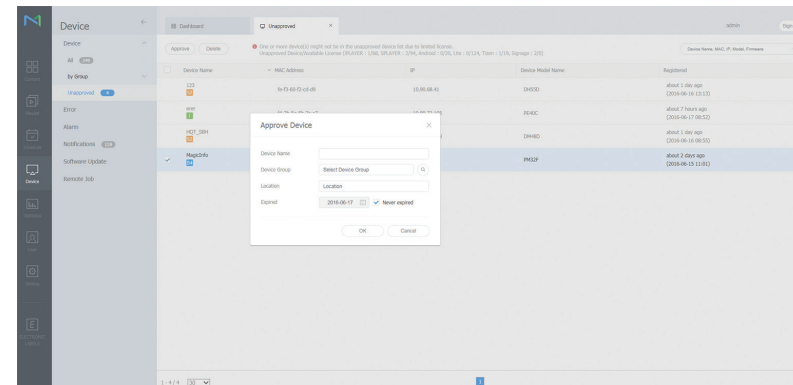

- 6 Enter the information required to approve the device.
  - **Device Name:** Enter the device name.
  - **Device Group:** Select **Q** to specify the group.
  - **Location:** Enter the current location of the device.
  - **Expired:** Set expiry date for the device's approval. If you do not want to set the expiry date, select **Never expired**.
  - Pressing the **INFO** button on the remote when a network schedule is running will display the details of the schedule. Check that the correct device has been selected by viewing the device ID in the details.

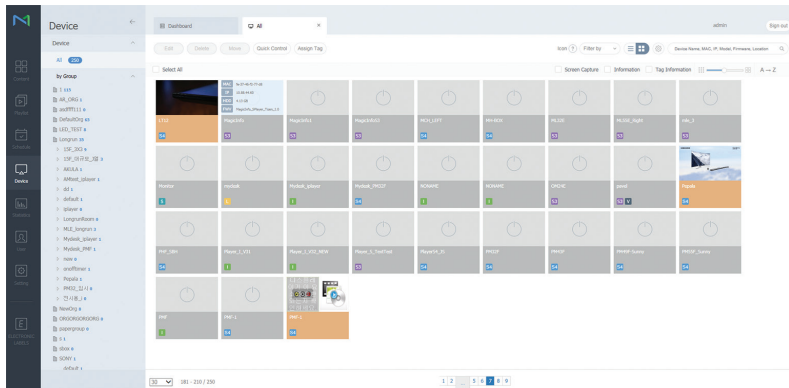

- 7 Select the **All** menu to check that the device has been registered.
- 8 When the device is approved by the server, the schedule registered in the selected group will be downloaded to the device. The schedule will run after it is downloaded.

- For further details on how to configure a schedule, refer to the “MagicInfo Server user’s manual”.
- If a device is deleted from the list of devices approved by the server, the device will reboot to reset its settings.

## Setting the current time

A schedule may not run if the time set on the device is different from the server’s current time.

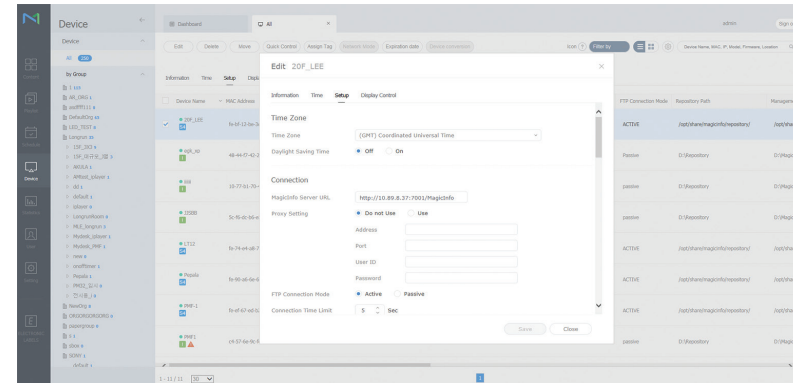

- 1 Select **Device** from the side menu bar.
- 2 Select your device.
- 3 Select **Edit** → **Setup**.
- 4 Select **Time Zone**.
  - When connecting to the server for the first time, the time on the product is set using the GMT time of the region where the server is installed.
  - The time on the product can be changed from the server.
  - Turning the product off and then on again will restore the time setting on the product to the last time that was set from the server.

- For further details on how to manage the time (scheduling, holiday management, etc.), refer to the “MagicInfo Server user’s manual”.

# Menu

## Screen adjustment

Picture ▼		
2nd	3rd	Description
Picture Mode	Shop & Mall / Office & School / Terminal & Station / Video Wall / Calibration	<p>Select a picture mode (<b>Picture Mode</b>) suitable for the environment where the product will be used.</p> <p><b>Video/Image</b> mode improves the picture quality of the video device. <b>Text</b> mode improves the picture quality of the computer.</p> <ul style="list-style-type: none"> <li>• <b>Calibration</b> In this mode, the brightness, color and gamma settings customized using the color calibration programme <b>Advanced Color Management</b> are applied.               <ul style="list-style-type: none"> <li>– To apply the <b>Calibration</b> mode properly, make sure you configure the picture quality settings, such as brightness, color and gamma, using the color calibration programme <b>Advanced Color Management</b>.</li> <li>– To download the <b>Advanced Color Management</b> programme, visit <a href="http://www.samsung.com/displaysolutions">www.samsung.com/displaysolutions</a>.</li> </ul> </li> </ul>
	Backlight / Contrast / Brightness / Sharpness / Color / Tint (G/R)	<p>Your product has several options for adjusting picture quality.</p> <ul style="list-style-type: none"> <li>• When you make changes to <b>Backlight, Contrast, Brightness, Sharpness, Color</b> or <b>Tint (G/R)</b>, the OSD will be adjusted accordingly.</li> <li>• You can adjust and store settings for each external device you have connected to an input on the product.</li> <li>• Lowering picture brightness reduces power consumption.</li> </ul>
Color Temperature		<p>Adjust the color temperature (Red / Green / Blue). (Range: 2800K–16000K)</p> <ul style="list-style-type: none"> <li>• Enabled when <b>Color Tone</b> is set to Off.</li> <li>• <b>Color Temperature</b> is disabled if <b>Picture Mode</b> is set to <b>Calibration</b>.</li> </ul>
White Balance	2 Point	Controls the white balance in 2 point interval by adjusting the red, green, and blue brightness.
	10 Point	<p>Controls the white balance in 10 point interval by adjusting the red, green, and blue brightness.</p> <ul style="list-style-type: none"> <li>• Some external devices may not support this function.</li> <li>• Enabled when <b>Picture Mode</b> is set to <b>Office &amp; School (Video/Image)</b>.</li> </ul>

## Picture ▼

2nd	3rd	Description
Gamma		Adjust the primary color intensity. <ul style="list-style-type: none"> <li>If <b>Picture Mode</b> is set to <b>Calibration</b>, <b>Gamma</b> is disabled.</li> </ul>
Calibrated Value		Select whether to apply the brightness, color and gamma settings customized using the color calibration programme <b>Advanced Color Management</b> to the Information and Advertisement modes. <ul style="list-style-type: none"> <li>To download the <b>Advanced Color Management</b> programme, visit <a href="http://www.samsung.com/displaysolutions">www.samsung.com/displaysolutions</a>.</li> <li>If <b>Picture Mode</b> is set to <b>Calibration</b>, <b>Calibrated Value</b> is disabled.</li> </ul>
Advanced Settings	Dynamic Contrast	Adjust the screen contrast.
	Black Tone	Select the black level to adjust the screen depth.
	Flesh Tone	Emphasize pink <b>Flesh Tone</b> .
	RGB Only Mode	Displays the <b>Red</b> , <b>Green</b> and <b>Blue</b> color for making fine adjustments to the hue and saturation.
	Color Space	Adjusts the range and variety of colors (the color space) available to create images. <ul style="list-style-type: none"> <li>To adjust <b>Color</b>, <b>Red</b>, <b>Green</b>, <b>Blue</b> and <b>Reset</b>, set <b>Color Space</b> to <b>Custom</b>.</li> </ul>
	HDMI UHD Color	Enable to optimize picture quality for HDMI UHD connections. Available for <b>HDMI1</b> , <b>HDMI2</b> and <b>DisplayPort</b> . <ul style="list-style-type: none"> <li>When this setting is on, only UHD products are supported.</li> <li>When this setting is on, you must apply the same settings on all the products in a loop out connection.</li> </ul>
	Motion Lighting	Reduces power consumption by reducing screen brightness when the picture on the screen is in motion. <ul style="list-style-type: none"> <li>Enabled when <b>Picture Mode</b> is set to <b>Terminal &amp; Station (Video/Image)</b>.</li> </ul>
Picture Options	Color Tone	Select a color tone that best suits your viewing needs. <ul style="list-style-type: none"> <li>If <b>Picture Mode</b> is set to <b>Calibration</b>, <b>Color Tone</b> is disabled.</li> <li>Settings can be adjusted and stored for each external device connected to an input on the product.</li> </ul>
	Digital Clean View	If the broadcast signal received by your product is weak, you can activate the <b>Digital Clean View</b> feature to reduce any static and ghosting that may appear on the screen. <ul style="list-style-type: none"> <li>Received signal intensity is the strongest when the bar is green.</li> <li>When the signal is weak, try all the options until the the product displays the best picture.</li> </ul>

## Picture ▼

2nd	3rd	Description
	<a href="#">Analog Clean View</a>	Reduce diagonal noise in picture caused by the crosstalk of signals.
	<a href="#">HDMI Black Level</a>	Selects the black level on the screen to adjust the screen depth.
	<a href="#">Film Mode</a>	This mode is suitable to view movies. Sets the product to automatically sense and process film signals from all sources and adjust the picture for optimum quality. <ul style="list-style-type: none"> <li>Available in <a href="#">TV</a>, <a href="#">HDMI</a> (1080i).</li> </ul>
	<a href="#">Dynamic Backlight</a>	Automatically adjust the backlight to provide the best possible screen contrast under the current conditions.
<a href="#">Picture Size</a>	<a href="#">Picture Size</a>	Different screen adjustment options are displayed depending on the current input source. <div style="border: 1px solid red; padding: 5px; margin-top: 10px;"> <p><b>CAUTION</b></p> <p>Do not set your product to 4:3 format for a long time.</p> <p>The borders displayed on the left and right, or top and bottom of the screen may cause image retention (screen burn) which is not covered by the warranty.</p> </div>
	<a href="#">Fit to Screen</a>	When selected, the full programme image will be displayed. No part of the image will be cut off.
	<a href="#">Zoom/Position</a>	Adjusts the picture zoom and position. <a href="#">Picture Size</a> must be set to <a href="#">Custom</a> for the option to be available. <ul style="list-style-type: none"> <li><a href="#">Custom</a> under <a href="#">Picture Size</a> is only enabled when <a href="#">Picture Mode</a> is set to <a href="#">Video/Image</a> while in <a href="#">DVI</a> mode.</li> <li>If you want to reset the picture to its original position, select <a href="#">Reset</a> in the <a href="#">Zoom/Position</a> screen. The picture will be set to its default position.</li> </ul>
<a href="#">Auto Adjustment</a>		Adjust frequency values/positions and fine tune the settings automatically.
<a href="#">PC Screen Adjustment</a>	<a href="#">Coarse / Fine</a>	Removes or reduces picture noise. If the noise is not removed by Fine-tuning alone, use the Coarse function to adjust the frequency as best as possible ( <a href="#">Coarse</a> ) and Fine-tune again. After the noise has been reduced, re-adjust the picture so that it is aligned with the center of screen.
	<a href="#">Position</a>	To adjust the PC's screen position if it is not centred or does not fit the product screen. Press the ▲ or ▼ button to adjust the vertical position. Press the ◀ or ▶ button to adjust the horizontal position.

## Picture ▼

2nd	3rd	Description
	<a href="#">Image Reset</a>	Resets the image to the default settings.
<a href="#">Picture Off</a>		Selecting <a href="#">Picture Off</a> switches off the screen. The volume is not disabled. To switch the screen on, press any button other than the volume button.
<a href="#">Reset Picture</a>		Resets your current picture mode to its default settings.

## OnScreen display adjustment

### OnScreen Display ▼

2nd	3rd	Description						
PIP	PIP / Source / Antenna / Channel / Size / Position / Sound Source	<p>The picture from the external video source will be in the main screen and the picture from the product will be in the PIP sub-picture screen.</p> <ul style="list-style-type: none"> <li>If you turn the product off while watching in the PIP mode, PIP mode will remain after power Off/On.</li> <li>You may notice that the picture in the PIP screen becomes slightly unnatural when you use the main screen to view a game or karaoke.</li> </ul> <table border="1"> <thead> <tr> <th>Main picture</th> <th>Sub picture</th> </tr> </thead> <tbody> <tr> <td>TV</td> <td>PC / HDMI / DisplayPort / DVI / MagicInfo</td> </tr> <tr> <td>PC / HDMI / DisplayPort / DVI</td> <td>TV</td> </tr> </tbody> </table> <ul style="list-style-type: none"> <li>If <b>Source Content Orientation</b> is set to <b>Portrait</b>, PIP is disabled.</li> <li><b>Plug In Module</b> mode is only supported when a PIM (sold separately) is connected to the product.</li> </ul>	Main picture	Sub picture	TV	PC / HDMI / DisplayPort / DVI / MagicInfo	PC / HDMI / DisplayPort / DVI	TV
Main picture	Sub picture							
TV	PC / HDMI / DisplayPort / DVI / MagicInfo							
PC / HDMI / DisplayPort / DVI	TV							
Display Orientation	Onscreen Menu Orientation	Set the menu screen orientation.						
	Source Content Orientation	Set the orientation of content from external devices connected to the product.						
	Aspect Ratio	<p>Set the rotated screen to be either full screen or original.</p> <ul style="list-style-type: none"> <li>Available only when <b>Source Content Orientation</b> is set to <b>Portrait</b>.</li> </ul>						
Screen Protection	Auto Protection Time	If the screen displays a still image for a certain period of time you define, the product activates the screen saver to prevent the formation of burnt in ghost images on the screen.						

## OnScreen Display ▼

2nd	3rd	Description
	<a href="#">Screen Burn Protection</a>	<p>To reduce the possibility of screen burn, this unit is equipped with <a href="#">Screen Burn Protection</a> screen burn prevention technology.</p> <p><a href="#">Screen Burn Protection</a> moves the picture slightly on the screen.</p> <ul style="list-style-type: none"> <li>• <a href="#">Pixel Shift</a> <ul style="list-style-type: none"> <li>– Minimize image retention by finely moving pixels horizontally or vertically.</li> <li>– Displaying a still image or a <b>4:3</b> output for an extended period of time may cause image retention. This is not a defect in the product.</li> </ul> </li> <li>• <a href="#">Timer</a> <ul style="list-style-type: none"> <li>– You can set the timer for <a href="#">Screen Burn Protection</a>.</li> <li>– The <a href="#">Screen Burn Protection</a> feature stops automatically after a specified period of time.</li> </ul> </li> <li>• <a href="#">Immediate Display</a> <ul style="list-style-type: none"> <li>– Select the screen saver you want to display immediately.</li> </ul> </li> </ul>
<a href="#">Message Display</a>	<a href="#">Source Info</a>	Select whether to display the source OSD when the input source changes.
	<a href="#">No Signal Message</a>	Select whether to display the no-signal OSD when no signal is detected.
	<a href="#">MDC Message</a>	Select whether to display the MDC OSD when the product is controlled by the MDC.
	<a href="#">Download Status Message</a>	Select to display the status when downloading content from a server or other device.
<a href="#">Language</a>		<p>Set the menu language.</p> <ul style="list-style-type: none"> <li>• A change to the language setting will only be applied to the onscreen menu display. It will not be applied to other functions on your PC.</li> </ul>
<a href="#">Reset OnScreen Display</a>		This option returns the current settings under <a href="#">OnScreen Display</a> to the default factory settings.



## Sound adjustment

### Sound ▼

2nd	3rd	Description
<a href="#">Sound Mode</a>		<p>You can select a sound mode to suit your personal preferences.</p> <ul style="list-style-type: none"> <li>If <a href="#">Sound Output</a> is set to <a href="#">External</a>, <a href="#">Sound Mode</a> is disabled.</li> </ul>
<a href="#">Balance</a>		<p>Adjust speaker volume levels for sound balance optimization.</p> <ul style="list-style-type: none"> <li>If <a href="#">Sound Output</a> is set to <a href="#">External</a>, <a href="#">Balance</a> is disabled.</li> </ul>
<a href="#">Equaliser</a>		<p>Adjust the equaliser to customise the volume and pitch, and enhance the richness of the sound output.</p> <ul style="list-style-type: none"> <li>If <a href="#">Sound Output</a> is set to <a href="#">External</a>, <a href="#">Equaliser</a> is disabled.</li> </ul>
<a href="#">HDMI Sound</a>		<p>Select the sound source whether to hear from <a href="#">AV(HDMI)</a> or <a href="#">PC(DVI)</a>.</p>
<a href="#">Sound on Video Call</a>		<p>Select sound output to listen to during a video call.</p>
<a href="#">Sound Output</a>		<p>If you are listening to the sound track of a broadcast or movie through an external receiver, you may hear a sound echo caused by the difference in decoding speed between the products speakers and the speakers attached to your audio receiver. If this occurs, set the product to <a href="#">External</a>.</p> <ul style="list-style-type: none"> <li>When you set <a href="#">Speaker Settings</a> to <a href="#">External</a>, the products speakers are turned off. You will hear sound through the external speakers only. When the <a href="#">Speaker Settings</a> is set to <a href="#">Internal</a>, both the product speakers and the external speakers are on. You will hear sound through both.</li> <li>If there is no video signal, both the products speakers and the external speakers will be mute.</li> </ul>
<a href="#">Auto Volume</a>		<p>The volume can vary depending on the channel.</p> <p>Automatically equalize the volume level when switching to another channel.</p> <ul style="list-style-type: none"> <li>To use the volume control of a connected source device, set <a href="#">Auto Volume</a> to <a href="#">Off</a>. A change to the volume control of the connected source device may not be applied if <a href="#">Auto Volume</a> is set to <a href="#">Normal</a> or <a href="#">Night</a>.</li> <li>If <a href="#">Speaker Settings</a> is set to <a href="#">External</a>, <a href="#">Auto Volume</a> is disabled.</li> </ul>
<a href="#">Reset Sound</a>		<p>Reset all sound settings to the factory defaults.</p>

## Broadcasting adjustment

---

### Broadcasting ▼

2nd	3rd	Description
<a href="#">Auto Program</a>		This feature automatically searches and saves all received channels. Follow the onscreen instruction to auto program.
<a href="#">Channel List</a>		Register or delete channels. Add favorite channels or rename analog channels. Select a desired channel from <a href="#">Channel List</a> to view the channel instantly. <ul style="list-style-type: none"><li>To navigate <a href="#">Channel List</a> faster, press the channel buttons. The channel list changes page by page.</li></ul>
<a href="#">Program Rating Lock</a>		You can customise the programs you wish to block, based on their ratings.
<a href="#">Expert Settings</a>		Configure advanced broadcasting settings such as Preferred Language and Multi-Track Sound.

## Network

Network ▼		
2nd	3rd	Description
<a href="#">Network Status</a>		You can check the current network and Internet status.
<a href="#">Open Network Settings</a>		Configure network settings to use various smart hub features such as Internet search, content sharing through a home network and feature updates.
<a href="#">Server Network Settings</a>	<a href="#">Connect to Server</a>	<p>To run <a href="#">Player</a> connect to a network.</p> <ul style="list-style-type: none"> <li>If the <a href="#">SSL</a> option is enabled, the server is configured to use https and data transfer is encrypted.</li> <li>Enter the server IP address and port number. Use 7001 as the port number. (If unable to connect to the server using port number 7001, check with your server administrator to find the correct port number and then change the port number.)</li> </ul>
	<a href="#">MagicInfo Mode</a>	Select the appropriate <a href="#">MagicInfo Mode</a> depending on the environment where you are using the product.
	<a href="#">Server Access</a>	Allow or deny access from MagicInfo server.
	<a href="#">FTP Mode</a>	Specify the FTP operating mode.
	<a href="#">Proxy Server</a>	Turn on or off and configure proxy server settings.
<a href="#">Wi-Fi Direct</a>		<p>Set to connect the product to wireless mobile devices. Using this function, you can connect wireless mobile devices with your product directly without a router.</p> <ul style="list-style-type: none"> <li>To use this function, your mobile device should be supported by the Wi-Fi Direct.</li> </ul> <p>To connect your mobile device with your product using Wi-Fi Direct, follow these steps:</p> <ol style="list-style-type: none"> <li>Go to <a href="#">Wi-Fi Direct</a> screen. The product starts to search devices.</li> <li>Turn on the <a href="#">Wi-Fi Direct</a> function on your device. Select the desired Wi-Fi device. <ul style="list-style-type: none"> <li><b>PBC</b> (Push Button Configuration): Press the <a href="#">WPS(PBC)</a> button on your Wi-Fi device within 2 minutes. Your product automatically acquires all the network setting values it needs and connects to your network.</li> <li><b>PIN</b>: Input the displayed <a href="#">PIN</a> on your device.</li> </ul> </li> </ol> <ul style="list-style-type: none"> <li>If you want to disconnect the device, select the connected Wi-Fi device, and then select <a href="#">Disconnected</a>.</li> </ul>

## Network ▼

2nd	3rd	Description
<a href="#">Mobile Device Manager</a>	<a href="#">Access Notification</a>	Change the settings for notification display when device is connected.
	<a href="#">Mobile Device List</a>	View and manage connected devices.
<a href="#">Device Name</a>		Select or enter a device name. This name can be shown on network remote controls over the network.

## Network Settings (Wired)

### Connecting to a Wired Network

There are three ways to attach your product to your LAN using cable.

- You can attach your product to your LAN by connecting the LAN port on the back of your product to an external modem using a LAN cable. See the diagram below.

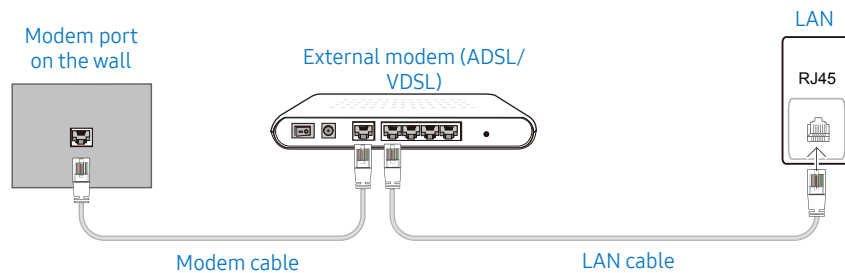

- You can attach your product to your LAN by connecting the LAN port on the back of your product to an IP Sharer which is connected to an external modem. Use LAN cable for the connection. See the diagram below.

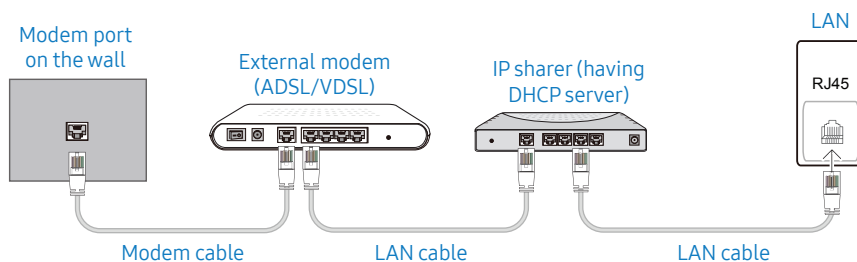

- Depending on how your network is configured, you may be able to attach your product to your LAN by connecting the LAN port on the back of your product directly to a network wall outlet using a LAN cable. See the diagram below. Note that the wall outlet is attached to a modem or router elsewhere in your house.

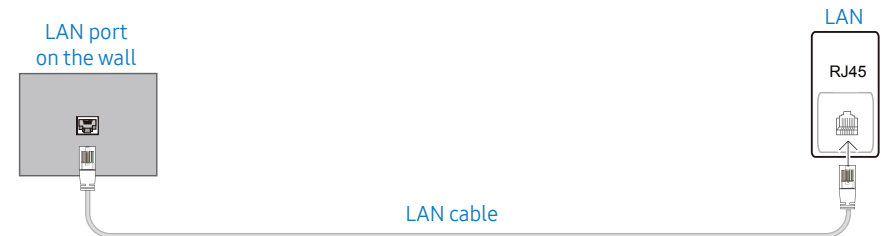

If you have a Dynamic Network, you should use an ADSL modem or router that supports the Dynamic Host Configuration Protocol (DHCP). Modems and routers that support DHCP automatically provide the IP address, subnet mask, gateway, and DNS values your product needs to access the Internet so you do not have to enter them manually. Most home networks are Dynamic Networks.

Some networks require a Static IP address. If your network requires a Static IP address, you must enter the IP address, subnet mask, gateway, and DNS values manually on your product Cable Setup Screen when you set up the network connection. To get the IP address, subnet mask, gateway, and DNS values, contact your Internet Service Provider (ISP).

If you have a Windows computer, you can also get these values through your computer.

- You can use ADSL modems that support DHCP if your network requires a Static IP address.
- ADSL modems that support DHCP also let you use Static IP addresses.

## Automatic Network Settings (Wired)

Connect to the network using a LAN cable.

Make sure a LAN cable is connected first.

### How to set up automatically

- 1 Press the **MENU** button on the remote control.
- 2 Select **Network - Open Network Settings**.
- 3 Select **Wired**.
  - The network test screen appears and then the verification process starts.
- 4 When the connection has been verified, select **OK**.
  - If the connection process fails, check the LAN port connection.
  - If the automatic process cannot find the network connection values or if you want to set the connection manually, go to the next section, network setup.

## Manual Network Settings (Wired)

Offices may use static IP addresses.

If this is the case, ask the network administrator for the IP address, subnet mask, gateway and DNS server address. Enter these values manually.

### Getting the Network Connection Values

To view the Network connection values on most Windows computers, follow these steps.

- 1 Right click the Network icon on the bottom right of the screen.
- 2 In the pop-up menu that appears, click **Status**.
- 3 On the dialog that appears, click the **Support** tab.
- 4 On the **Support** Tab, click the **Details** button. The Network connection values are displayed.

### How to set up manually

- 1 Press the **MENU** button on the remote control.
- 2 Select **Network - Open Network Settings**.
- 3 Select **Wired**.
  - The network test screen appears and then the verification process starts.
- 4 Select **Stop**. The verification process stops.

- 5 Select **IP Settings**. The **IP Settings** screen appears.
- 6 Select **IP Setting** and set it to **Enter manually**.
  - Setting **IP Setting** to **Enter manually** automatically changes DNS Setting to **Enter manually**.
- 7 Enter the network connection values.
  - **IP Address, Subnet Mask, Gateway, DNS Server**.
- 8 When done, select **OK** at the bottom of the page, and then press **ENTER**. The network test screen appears and the verification process starts.
- 9 When the connection has been verified, select **OK**.

## Network Setting (Wireless)

### Connecting to a Wireless Network

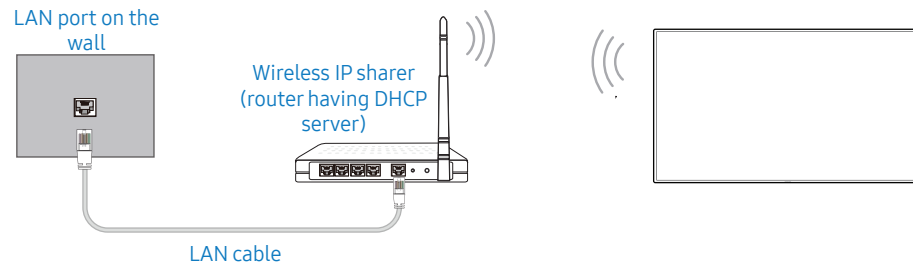

Samsung recommends using IEEE 802.11n. When you play video over a network connection, the video may not play smoothly.

- Select a channel for the wireless IP sharer that is not currently being used. If the channel set for the wireless IP sharer is currently being used by another device nearby, this will result in interference and communication failure.
- Your product supports only the following wireless network security protocols. If you select the Pure High-throughput (Greenfield) 802.11n mode and the Encryption type is set to WEP, TKIP or TKIP AES (WPS2Mixed) on your AP or wireless router, Samsung products will not support a connection in compliance with new Wi-Fi certification specifications.
- If your wireless router supports WPS (Wi-Fi Protected Setup), you can connect to the network via PBC (Push Button Configuration) or PIN (Personal Identification Number). WPS will automatically configure the SSID and WPA key in either mode.
- Connection Methods: You can setup the wireless network connection in three ways. Auto Setup (Using the Auto Network Search function), Manual Setup, **WPS(PBC)**

### Automatic Network Setup (Wireless)

Most wireless networks have an optional security system that requires devices that access the network to transmit an encrypted security code called an Access or **Security Key**. The **Security Key** is based on a Pass Phrase, typically a word or a series of letters and numbers of a specified length you were asked to enter when you set up security for your wireless network. If you use this method of setting up the network connection, and have a **Security Key** for your wireless network, you will have to enter the Pass Phrase during the the automatic or manual setup process.

#### How to set up automatically

- 1 Press the **MENU** button on the remote control.
- 2 Select **Network - Open Network Settings**.
- 3 Select **Wireless**.
  - The network function searches for available wireless networks. When done, it displays a list of the available networks.
- 4 In the list of networks, press the **▲** or **▼** button to select a network, and then press **ENTER**.
  - If the desired wireless router does not appear, select **Refresh** to search again.
  - If the router cannot be found after retrying, select the **Stop** button. The **Add Network** button appears and you can set the network manually.
- 5 If the **Enter password** screen appears, go to step 6. If you select a wireless router that does not have security, go to step 8.
- 6 If the router has security, enter the password. (Security key or PIN).
- 7 When done, use the **▶** button to move the cursor to **Done**, and then press **ENTER**. The network test screen appears and then the verification process starts.
- 8 When the connection has been verified, select **OK**.

## Manual Network Setup (Wireless)

Offices may use static IP addresses.

If this is the case, ask the network administrator for the IP address, subnet mask, gateway and DNS server address. Enter these values manually.

### Getting the Network Connection Values

To view the Network connection values on most Windows computers, follow these steps.

- 1 Right click the Network icon on the bottom right of the screen.
- 2 In the pop-up menu that appears, click **Status**.
- 3 On the dialog that appears, click the **Support** tab.
- 4 On the **Support** Tab, click the **Details** button. The Network connection values are displayed.

### How to set up manually

- 1 Press the **MENU** button on the remote control.
- 2 Select **Network - Open Network Settings**.
- 3 Select **Wireless**.
  - The network function searches for available wireless networks. When done, it displays a list of the available networks.
- 4 Select **Stop**. The verification process stops.
- 5 Select **Add Network**.
- 6 Enter the SSID of the network and select **Done**.
- 7 Select the **Security type** and select **OK**. If you select **Open**, move to step 10.
- 8 If the router has security, enter the password. (Security key or PIN)
- 9 When done, use the **▶** button to move the cursor to **Done**, and then press **↩**. The network test screen appears and then the verification process starts.
- 10 When the connection has been verified, select **OK**.

## WPS(PBC)

### How to set up using WPS(PBC)

If your router has a WPS(PBC) button, follow these steps.

- 1 Press the **MENU** button on the remote control.
- 2 Select **Network - Open Network Settings**.
- 3 Select **Wireless**.
  - The network function searches for available wireless networks. When done, it displays a list of the available networks.
- 4 Select **Stop**. The verification process stops.
- 5 Select **Use WPS** and press **↩**.
- 6 Press the **WPS(PBC)** button on your router within 2 minutes. Your product automatically acquires all the network setting values it needs and connects to your network.
- 7 The network connection screen appears, and network setup is done.



## System

System ▼		
2nd	3rd	Description
Accessibility	Voice Guide	Switch <b>Voice Guide</b> on or off and configure the volume, speed and pitch of the voice. The language used for Voice Guide will be the same as the language to be set in <b>Language</b> .
	Video Description	Hear a verbal description of what is happening on the screen. this function is only available with broadcasts that provide this service.
	Caption	Turn <b>Caption</b> on or off and configure caption settings.
	Menu Transparency	Adjust transparency of menu box.
	High Contrast	Set the background and font to high-contrast colors in Menu. Menu transparencies become opaque when the option is selected.
Enlarge	Enlarge	Enlarge the size of the menu.
	Start Setup	Restore your TV to its original settings and perform initial <b>Setup</b> again. <ul style="list-style-type: none"> <li>Enter your 4 digit PIN number. The default PIN number is "0-0-0-0". If you want to change the PIN number, use the <b>Change PIN</b> function.</li> </ul>
Time		You can configure <b>Clock</b> or <b>Sleep Timer</b> . You can also set the product to automatically turn on or off at a specified time using the <b>Timer</b> function. <ul style="list-style-type: none"> <li>Press the <b>INFO</b> button if you want to view the current time.</li> </ul>
	Clock	Select <b>Clock</b> . Select <b>Date</b> or <b>Time</b> , and then press <b>Enter</b> . Use the number buttons to enter numbers or press the up and down arrow buttons. Use the ◀ and ▶ buttons to move from one entry field to the next. Press <b>Enter</b> when done.
	DST	Switches the DST (Daylight Saving Time) function on or off.
	Sleep Timer	Automatically shuts off the product after a preset period of time. <ul style="list-style-type: none"> <li>Use the up and down arrows to select a period of time, and then press <b>Enter</b>. To cancel <b>Sleep Timer</b>, select <b>Off</b>.</li> </ul>

## System ▼

2nd	3rd	Description
	<a href="#">Power On Delay</a>	When connecting multiple products, adjust the power-on time for each product to prevent power overload (within the range 0–50 seconds).
<a href="#">Auto Source Switching</a>		Turning on the display with <a href="#">Auto Source Switching On</a> , and the previous video source selection is not active, the display will automatically search the different video input sources for active video.
	<a href="#">Auto Source Switching</a>	When the <a href="#">Auto Source Switching</a> is <a href="#">On</a> , the display video source will automatically be searched for active video. The <a href="#">Primary Source</a> selection will be activated, if the current video source is not recognized. <a href="#">Secondary Source</a> selection will become active, if no primary video source is available. If both the primary and secondary input sources are not recognized, the display will perform two searches for an active source, each search checking the primary and then secondary source. If both searches fail, the display will return to the first video source and display a message indicating that there is no signal. When the <a href="#">Primary Source</a> selection is set to <a href="#">All</a> , the display will search all the video source inputs twice in sequence looking for an active video source, returning back to the first video source in the sequence if no video is found.
	<a href="#">Primary Source Recovery</a>	Select whether to restore the selected primary input source when a primary input source is connected. <ul style="list-style-type: none"> <li>The <a href="#">Primary Source Recovery</a> function is disabled if <a href="#">Primary Source</a> is set to <a href="#">All</a>.</li> </ul>
	<a href="#">Primary Source</a>	Specify <a href="#">Primary Source</a> for the automatic input source.
	<a href="#">Secondary Source</a>	Specify <a href="#">Secondary Source</a> for the automatic input source.
<a href="#">DVI Connection</a>		Select the source device that is connected to the DVI input. <ul style="list-style-type: none"> <li>Restart the source device if the screen is not displayed.</li> </ul>
<a href="#">Power Control</a>	<a href="#">Auto Power On</a>	This feature automatically turns on the product as soon as it is plugged in. Pressing the power button is not needed.
	<a href="#">PC Module Power</a>	The PC module can be turned on/off separately from the LFD.
	<a href="#">Max. Power Saving</a>	Turns off the product to reduce power consumption after the PC has been left idle for a specified period of time. <ul style="list-style-type: none"> <li>Available only <a href="#">DVI</a>, <a href="#">HDMI</a>, <a href="#">DisplayPort</a> mode.</li> </ul>

## System ▼

2nd	3rd	Description
	<a href="#">Standby Control</a>	<p>You can set the screen standby mode to be applied when an input signal is received.</p> <ul style="list-style-type: none"> <li>Available only <a href="#">DVI</a>, <a href="#">HDMI</a>, <a href="#">DisplayPort</a> mode.</li> <li>Ensure that the source device is connected correctly when the <a href="#">Signal is weak or no signal</a> message appears.</li> <li>If <a href="#">No Signal Message</a> is set to <a href="#">Off</a>, the <a href="#">Signal is weak or no signal</a> message does not appear. Set <a href="#">No Signal Message</a> to <a href="#">On</a>.</li> </ul>
	<a href="#">Network Standby</a>	This feature keeps the network power on when the product turns off.
	<a href="#">Power Button</a>	The power button (on the top left corner of the remote control) can be set to either turn on the power or turn on/off the power.
<a href="#">Eco Solution</a>	<a href="#">Energy Saving Mode</a>	Reduce the power consumption by adjusting the screen brightness.
	<a href="#">Eco Sensor</a>	<p>To enhance your power savings, the picture settings will automatically adapt to the light in the room.</p> <ul style="list-style-type: none"> <li>Adjusting the <a href="#">Backlight</a> setting in the <a href="#">Picture</a> menu disables the <a href="#">Eco Sensor</a>.</li> <li>If <a href="#">Eco Sensor</a> is <a href="#">On</a>, the display brightness may change (become slightly darker or brighter) depending on the surrounding light intensity.</li> </ul>
	<a href="#">Screen Lamp Schedule</a>	Adjust the panel brightness. A value closer to 100 makes the panel brighter.
	<a href="#">No Signal Power Off</a>	<p>Save power by turning the device off when no signal is received from any source.</p> <ul style="list-style-type: none"> <li>Disabled when an attached PC is in power saving mode.</li> <li>The product will automatically power off at a specified time. The time can be changed as required.</li> </ul>
	<a href="#">Auto Power Off</a>	The product will automatically turn off if you don't press a button on the remote or touch a button on product front panel within select hours to prevent overheating.

## System ▼

2nd	3rd	Description
Temperature Control		<p>This function detects the internal temperature of the product. You can specify the temperature range that is acceptable.</p> <p>The default temperature is set to 171 °F.</p> <p>The recommended operating temperature for this product is 167 to 176 °F (based on an ambient temperature of 104 °F).</p> <ul style="list-style-type: none"> <li>The screen will become darker if the current temperature exceeds the specified temperature limit. If the temperature continues to rise, the product will power off to prevent overheating.</li> </ul>
Input Device Manager		Set the language, type and input language shortcut for a connected keyboard.
Play via		<p>Select the appropriate <b>Play via</b> mode depending on the environment where you are using the product.</p> <p>The home screen may be different depending on the setting.</p>
Change PIN		<p>The <b>Change PIN</b> screen will appear.</p> <p>Choose any 4 digits for your PIN and enter it in <b>Enter New PIN</b>. Reenter the same 4 digits in <b>Confirm New PIN</b>.</p> <ul style="list-style-type: none"> <li>Default password: 0 - 0 - 0 - 0</li> </ul>
Security	Safety Lock	<ul style="list-style-type: none"> <li>Enter your 4 digit PIN number and press . The default PIN number is "0-0-0-0". If you want to change the PIN number, use the <b>Change PIN</b> function.</li> </ul> <p>All the menus and buttons of the product and remote control, except for the <b>LOCK</b> button on the remote control, will be locked by the <b>Safety Lock</b> function.</p> <p>To unlock the menus and buttons, press any button and then enter the password (default password: 0 - 0 - 0 - 0).</p> <p>Turn on <b>Power On Button</b> to enable the remote control's Power button to turn on the device while <b>Safety Lock</b> is enabled.</p>
	Button Lock	<p>This menu can be used to lock the button on the product.</p> <p>Only the remote control can control the product if <b>Button Lock</b> is set to <b>On</b>.</p>
	USB Auto Play Lock	<p>Select whether to automatically play <b>MagicInfo</b> content saved on a connected USB device.</p> <ul style="list-style-type: none"> <li>Connecting a USB device containing <b>MagicInfo</b> content displays "<b>USB Auto Play Lock : On</b>" for five seconds.</li> </ul>
	Mobile Connection Lock	Restrict other devices on your network, such as smart phones and tablets, to share content with your signage.

## System ▼

2nd	3rd	Description
	<a href="#">Touch Control Lock</a>	Prevent touch gestures from controlling your device.
<a href="#">General</a>	<a href="#">Smart Security</a>	This function protects all the external devices connected to the TV from hackers, spywares, and viruses.
	<a href="#">Anynet+ (HDMI-CEC)</a>	Refer to “Anynet+ (HDMI-CEC)” on page 70.
	<a href="#">HDMI Hot Plug</a>	This feature is used to activate the time delay to turn on a DVI/HDMI source device.
	<a href="#">Game Mode</a>	When connecting to a game console such as PlayStation™ or Xbox™, you can enjoy a more realistic gaming experience by selecting game mode. <ul style="list-style-type: none"> <li>Precautions and limitations for Game Mode <ul style="list-style-type: none"> <li>To disconnect the game console and connect another external device, set Game Mode to Off in the setup menu.</li> </ul> </li> </ul>
<a href="#">Reset System</a>		This option returns the current settings under system to the default factory settings.

## Anynet+ (HDMI-CEC)

### Anynet+ (HDMI-CEC)

Anynet+ is a function that enables you to control all connected Samsung devices that support Anynet+ with your Samsung product remote. The Anynet+ system can be used only with Samsung devices that have the Anynet+ feature. To be sure your Samsung device has this feature, check if there is an Anynet+ logo on it.

- You can only control Anynet+ devices using the product remote control, not the buttons on the product.
- The product remote control may not work under certain conditions. If this occurs, reselect the Anynet+ device.
- **Anynet+** works when the AV device supporting **Anynet+** is in the standby or on status.
- While in **PIP** mode, **Anynet+** functions only when an AV device is connected as the primary display. It does not work if the AV device is connected as a secondary display.
- **Anynet+** supports up to 12 AV devices in total. Note that you can connect up to 3 devices of the same type.

## Troubleshooting for Anynet+

Problem	Possible Solution
Anynet+ does not work.	<ul style="list-style-type: none"> <li>• Check if the device is an Anynet+ device. The Anynet+ system supports Anynet+ devices only.</li> <li>• Check if the Anynet+ device power cord is properly connected.</li> <li>• Check the Anynet+ device's Video/Audio/HDMI cable connections.</li> <li>• Check whether <b>Anynet+ (HDMI-CEC)</b> is set to <b>On</b> in the <b>System</b> menu.</li> <li>• Check whether the remote control is Anynet+ compatible.</li> <li>• Anynet+ doesn't work in certain situations. (initial setup)</li> <li>• If you have removed and then reconnected the HDMI cable, please make sure to search devices again or turn your</li> <li>• product off and on again.</li> <li>• Check if the Anynet+ function of the Anynet device is set on.</li> </ul>
I want to start Anynet+.	<ul style="list-style-type: none"> <li>• Check if the Anynet+ device is properly connected to the product and check if the <b>Anynet+ (HDMI-CEC)</b> is set to <b>On</b> in the <b>System</b> menu.</li> </ul>
I want to exit Anynet+.	<ul style="list-style-type: none"> <li>• Press the <b>SOURCE</b> button on the product remote control and select a non- Anynet+ device.</li> </ul>

Problem	Possible Solution
The message “Disconnecting Anynet+ device ...” appears on the screen.	<ul style="list-style-type: none"><li>• You cannot use the remote control when you are configuring Anynet+ or switching to a view mode.</li><li>• Use the remote control after the product has completed Anynet+ configuration or has finished switching to Anynet+.</li></ul>
The Anynet+ device does not play.	<ul style="list-style-type: none"><li>• You cannot use the play function when initial setup is in progress.</li></ul>
The connected device is not displayed.	<ul style="list-style-type: none"><li>• Check whether or not the device supports Anynet+ functions.</li><li>• Check whether or not the HDMI cable is properly connected.</li><li>• Check whether <a href="#">Anynet+ (HDMI-CEC)</a> is set to <b>On</b> in the <a href="#">System</a> menu.</li><li>• Search Anynet+ devices again.</li><li>• Anynet+ requires an HDMI connection. Make sure the device is connected to your product with an HDMI cable.</li><li>• Some HDMI cables may not support Anynet+ functions.</li><li>• If the connection is terminated because there has been a power failure or the HDMI cable has been disconnected, please repeat the device scan.</li></ul>

## Support

---

### Support ▼

2nd	3rd	Description
<a href="#">Software Update</a>		<p>The <a href="#">Software Update</a> menu lets you upgrade your product software to the latest version.</p> <ul style="list-style-type: none"> <li>• Be careful not to turn off the power until the upgrade is complete. The product will turn off and on automatically after completing the software upgrade.</li> <li>• When you upgrade software, all video and audio settings you have made will return to their default settings. We advise you to write down your settings so that you can easily reset them after the upgrade.</li> </ul>
	<a href="#">Update now</a>	Update the software to the latest version.
	<a href="#">Auto Update</a>	This feature automatically updates the product when not in use.
<a href="#">Contact Samsung</a>		<p>View this information when your product does not work properly or when you want to upgrade the software. You can find information regarding our call centres and how to download products and software.</p> <ul style="list-style-type: none"> <li>• Contact Samsung and find the product <a href="#">Model Code</a> and <a href="#">Software Version</a>.</li> </ul>
<a href="#">Reset All</a>		This option returns all the current settings for a display to the default factory settings.



# Troubleshooting

## Before you contact us

---

Before calling Samsung Customer Service Center, test your product as follows. If the problem persists, contact Samsung Customer Service Center.

### Diagnosis

Check if your product is operating normally by using the product test function.

If the screen remains blank while the power LED blinks even when the product is correctly connected to a PC, perform product testing.

- 1 Power off both the PC and product.
- 2 Disconnect all the cables from the product.
- 3 Power on the product.
- 4 If **No Cable Connected** is displayed, the product is operating normally.

If the screen remains blank, check the PC system, video controller and cable.

### Screen Resolution

**Not Optimum Mode** will briefly be displayed if a mode that exceeds a supported resolution is selected (refer to Supported Resolutions).

## Checkpoints

### Installation issue (PC mode)

The screen keeps switching on and off.	Check the cable connection between the product and PC, and ensure the connection is secure.
Blank spaces are found on all four sides of the screen when an HDMI or HDMI-DVI cable is connected to the product and PC.	The blank spaces found on the screen have nothing to do with the product.
	Blank spaces on the screen are caused by the PC or graphics card. To resolve the problem, adjust the screen size in the HDMI or DVI settings for the graphics card.
	If the graphics card settings menu does not have an option to adjust the screen size, update the graphics card driver to the latest version. (Please contact the graphics card or computer manufacturer for further details about how to adjust the screen settings.)
PC is shown in <b>Source</b> when a PC is not connected.	PC is always shown in Source irrespective of whether or not a PC is connected.

### Screen issue

The power LED is off. The screen will not switch on.	Check the cable connection between the product and PC, and ensure the connection is secure.
<b>No Cable Connected</b> is displayed on the screen.	Check that the product is connected correctly with a cable.
	Check that the device connected to the product is powered on.
<b>Not Optimum Mode</b> is displayed.	This message is displayed when a signal from the graphics card exceeds the product's maximum resolution and frequency.
	Refer to the Standard Signal Mode Table and set the maximum resolution and frequency according to the product specifications.
The images on the screen look distorted.	Check the cable connection to the product.
The screen is not clear. The screen is blurry.	Adjust <b>Coarse</b> and <b>Fine</b> .
	Remove any accessories (video extension cable, etc) and try again.
	Set the resolution and frequency to the recommended level.

The screen appears unstable and shaky.	Check that the resolution and frequency of the PC and graphics card are set within a range compatible with the product. Then, change the screen settings if required by referring to the Additional Information on the product menu and the Standard Signal Mode Table.
There are shadows or ghost images left on the screen.	Check that the resolution and frequency of the PC and graphics card are set within a range compatible with the product. Then, change the screen settings if required by referring to the Additional Information on the product menu and the Standard Signal Mode Table.
The screen is too bright. The screen is too dark.	Adjust <b>Brightness</b> and <b>Contrast</b> .
Screen color is inconsistent.	Go to <b>Picture</b> and adjust the <b>Color Space</b> settings.
White does not really look white.	Go to <b>Picture</b> and adjust the <b>White Balance</b> settings.
There is no image on the screen and the power LED blinks every 0.5 to 1 second.	The product is in power saving mode.
	Press any key on the keyboard or move the mouse to return to the previous screen.
The product will turn off automatically.	Go to System and make sure Sleep Timer is set to Off.
	If a PC is connected to the product, check the power status of the PC.
	Make sure the power cable is connected properly to the product and power outlet.
	If the signal from a connected device is not detected, the product automatically turns off after 10 to 15 minutes.
Picture quality of the product is different from the dealer shop where it was purchased.	Use an HDMI cable to obtain high-definition (HD) picture quality.
The screen display does not look normal.	Encoded video content may cause the display to appear corrupted in scenes featuring fast moving objects such as in a sports event or action video.
	Low signal level or low picture quality may cause the display to appear corrupted. This does not mean the product is defective.
	A cell phone within a distance of 3.3 ft radius may cause static on analogue and digital products.
The brightness and color do not look normal.	Go to <b>Picture</b> and adjust the screen settings such as <b>Picture Mode</b> , <b>Color</b> , <b>Brightness</b> and <b>Sharpness</b> .
	Go to <b>System</b> and adjust the <b>Energy Saving Mode</b> settings.
	Reset the screen settings to the default settings.
Broken lines are displayed on the edges of the screen.	If <b>Picture Size</b> is set to <b>Fit to Screen</b> , change the setting to <b>16:9 Standard</b> .
Lines (red, green or blue) are displayed on the screen.	These lines are displayed when there is a defect in DATA SOURCE DRIVER IC on the monitor. Contact a Samsung Service Center to resolve the issue.

The display looks unstable and then freezes.	The screen may freeze when a resolution other than the recommended resolution is used or if the signal is not stable. To resolve the issue, change the PC resolution to the recommended resolution.
The screen cannot be displayed in full screen.	A scaled SD (4:3) content file can cause black bars on both sides of an HD channel screen.
	A video with an aspect ratio different from the product can cause black bars at the top and bottom of the screen.
	Change the screen size setting to full screen on the product or source device.

### Sound issue

There is no sound.	Check the connection of the audio cable or adjust the volume.
	Check the volume.
The volume is too low.	Adjust the volume.
	If the volume is still low after turning it up to the maximum level, adjust the volume on your PC sound card or software programme.
Video is available but there is no sound.	If an HDMI cable is connected, check the audio output settings on the PC.
	Go to <a href="#">Sound</a> and change <a href="#">Sound Output</a> to <a href="#">Internal</a> .
	If a source device is used
	<ul style="list-style-type: none"> <li>• Make sure the audio cable is properly connected to the audio input port on the product.</li> <li>• Check the audio output settings for the source device. (For example, if an HDMI cable is connected to the monitor, the audio setting for the cable box may need to be changed to HDMI.)</li> </ul>
	If a DVI-HDMI cable is used, a separate audio cable is required.
	If the product has a headphone port, make sure nothing is connected to it.
	Reconnect the power cable to the device and then reboot the device.
There is static coming from the speakers.	Check the cable connection. Make sure a video cable is not connected to an audio input port.
	Check the signal strength after connecting a cable.
	Low signal level can cause corrupted sound.

There is audible sound when the volume is muted.	<p>When <b>Sound Output</b> is set to <b>External</b>, the volume button and mute function are disabled. Adjust the volume for the external speakers.</p> <p>Audio settings for main speakers are separate from the internal speakers on the product. Changing or muting the volume on the product does not affect an external amplifier(decoder).</p>
Sound from the monitor does not change after <b>Sound Mode</b> is changed.	<p>Audio settings for main speakers are separate from the internal speakers on the product. Audio settings on a source device do not affect the internal speaker settings on the product.</p>
There is an echo sound coming from the speakers.	<p>Different decoding speeds between the product speakers and external speakers can cause an echo. In this case, set <b>Sound Output</b> to <b>External</b>.</p>

### Remote control issue

The remote control does not work.	Make sure that the batteries are correctly in place (+/-).
	Check if the batteries are flat.
	Check for power failure.
	Make sure that the power cord is connected.
	Check for any special lighting or neon signs switched on in the vicinity.

### Source device issue

A beeping sound is heard when my PC is booting.	If a beeping sound is heard when your PC is booting, have your PC serviced.
---	---

### Other issue

The product smells like plastic.	The plastic smell is normal and disappears over time.
The monitor appears tilted.	Remove and then attach the stand again to the product.
Audio or video cuts out intermittently.	Check the cable connection and connect it again if required.
	<p>Using a very hard or thick cable may corrupt audio and video files.</p> <p>Make sure cables are flexible enough to ensure durability. When mounting the product onto a wall, it is recommended to use right-angle cables.</p>

Small particles are found on the edges of the product.	The particles are part of the product design. The product is not defective.									
The <b>PIP</b> menu is not available.	The menu is enabled or disabled depending on the <b>Source</b> mode.									
When I try to change the PC resolution, a message “ <b>The defined resolution is not supported.</b> ” appears.	The message “ <b>The defined resolution is not supported.</b> ” appears if the input source resolution exceeds the maximum resolution of the display. To resolve the issue, change the PC resolution to a resolution supported on the display.									
There is no sound from the speakers in HDMI mode when a DVI-HDMI cable is connected.	DVI cables do not transmit sound data. Make sure to connect the audio cable to the correct input jack to enable audio.									
<b>HDMI Black Level</b> is not functioning properly on an HDMI device with YCbCr output.	This function is available only when a source device, such as a DVD player and STB, is connected to the product via an HDMI (RGB signal) cable.									
There is no sound in HDMI mode.	<p>Displayed picture colors may not look normal. Video or sound may not be available. This can occur if a source device that only supports an older version of the HDMI standard is connected to the product. If these issues occur, connect an audio cable along with the HDMI cable.</p> <p>Some PC graphics cards may not automatically recognize HDMI signals that do not include sound. In this case, manually select a sound input.</p> <table border="1"> <thead> <tr> <th></th> <th>Sound input</th> <th>Screen mode</th> </tr> </thead> <tbody> <tr> <td>PC</td> <td>Auto</td> <td>PC settings</td> </tr> <tr> <td>DVI PC</td> <td>Audio In (Stereo ports)</td> <td>PC settings</td> </tr> </tbody> </table>		Sound input	Screen mode	PC	Auto	PC settings	DVI PC	Audio In (Stereo ports)	PC settings
	Sound input	Screen mode								
PC	Auto	PC settings								
DVI PC	Audio In (Stereo ports)	PC settings								
In power saving mode, when the input source is <b>DisplayPort</b> , PC display settings cannot be saved.	Go to <b>System</b> → <b>Power Control</b> and set <b>Max. Power Saving</b> to <b>Off</b> . Alternatively, configure the PC display output settings again. Ensure the set is turned on.									
When booting the PC with the input source set to <b>DisplayPort</b> , the BIOS and booting screens do not appear.	Boot the PC when the set is turned on or when the input source is not <b>DisplayPort</b> .									

## Frequently asked questions

Refer to the user manual for your PC or graphics card for further instructions on adjustment.

Question	Answer
How can I change the frequency?	<p>Set the frequency on your graphics card.</p> <ul style="list-style-type: none"> <li>• Windows 7: Go to <a href="#">Control Panel</a> → <a href="#">Appearance and Personalization</a> → <a href="#">Display</a> → <a href="#">Adjust resolution</a> → <a href="#">Advanced Settings</a> → <a href="#">Monitor</a> and adjust the frequency in <a href="#">Monitor Settings</a>.</li> <li>• Windows 8: Go to <a href="#">Settings</a> → <a href="#">Control Panel</a> → <a href="#">Appearance and Personalization</a> → <a href="#">Display</a> → <a href="#">Adjust resolution</a> → <a href="#">Advanced Settings</a> → <a href="#">Monitor</a> and adjust the frequency in <a href="#">Monitor Settings</a>.</li> <li>• Windows 10: Go to <a href="#">Settings</a> → <a href="#">System</a> → <a href="#">Display</a> → <a href="#">Advanced display settings</a> → <a href="#">Display adapter properties</a> → <a href="#">Monitor</a>, and adjust <a href="#">Screen refresh rate</a> under <a href="#">Monitor settings</a>.</li> </ul>
How can I change the resolution?	<ul style="list-style-type: none"> <li>• Windows 7: Go to <a href="#">Control Panel</a> → <a href="#">Appearance and Personalization</a> → <a href="#">Display</a> → <a href="#">Adjust Resolution</a> and adjust the resolution.</li> <li>• Windows 8: Go to <a href="#">Settings</a> → <a href="#">Control Panel</a> → <a href="#">Appearance and Personalization</a> → <a href="#">Display</a> → <a href="#">Adjust Resolution</a> and adjust the resolution.</li> <li>• Windows 10: Go to <a href="#">Settings</a> → <a href="#">System</a> → <a href="#">Display</a> → <a href="#">Advanced display settings</a>, and adjust the resolution.</li> </ul>
How do I set power saving mode?	<ul style="list-style-type: none"> <li>• Windows 7: Set power saving mode in <a href="#">Control Panel</a> → <a href="#">Appearance and Personalization</a> → <a href="#">Personalization</a> → <a href="#">Screen Saver</a> → <a href="#">Change power settings</a> or BIOS SETUP on the PC.</li> <li>• Windows 8: Set power saving mode in <a href="#">Settings</a> → <a href="#">Control Panel</a> → <a href="#">Appearance and Personalization</a> → <a href="#">Personalize</a> → <a href="#">Screen Saver Settings</a> or BIOS SETUP on the PC.</li> <li>• Windows 10: Set power saving mode in <a href="#">Settings</a> → <a href="#">Personalization</a> → <a href="#">Lock screen</a> → <a href="#">Screen timeout settings</a> → <a href="#">Power &amp; sleep</a> or BIOS SETUP on the PC.</li> </ul>

# Appendix

## Specifications

### General

Model Name		PM32F	PM43F / PH43F	PM49F / PH49F	PM55F / PH55F
Panel	Size	32 CLASS (31.5 inches)	43 CLASS (42.5 inches)	49 CLASS (48.5 inches)	55 CLASS (54.6 inches)
	Display area	27.5 inches (H) x 15.5 inches (V)	37.0 inches (H) x 20.8 inches (V)	42.2 inches (H) x 23.7 inches (V)	47.7 inches (H) x 26.8 inches (V)
Audio Output		10 W + 10 W	10 W + 10 W	10 W + 10 W	10 W + 10 W
Power Supply		AC 100 to 240 VAC (+/- 10%), 60 / 50 Hz ± 3 Hz Refer to the label at the back of the product as the standard voltage can vary in different countries.			
Environmental considerations	Operating	Temperature : 32 °F – 104 °F, With PIM : 50 °F – 104 °F Humidity : 10% – 80%, non-condensing			
	Storage	Temperature : -4 °F – 113 °F Humidity : 5% – 95%, non-condensing			

**CAUTION**

For installing the housing, keep the internal temperature at 104 °F or below.

- **Plug-and-Play**

This monitor can be installed and used with any Plug-and-Play compatible systems. Two-way data exchange between the monitor and PC system optimizes the monitor settings. Monitor installation takes place automatically. However, you can customise the installation settings if desired.

- Due to the nature of the manufacturing of this product, approximately 1 pixel per million (1ppm) may appear brighter or darker on the panel. This does not affect product performance.
- This device is a Class A digital apparatus.



**Recommendation - EU only**

- Hereby, Samsung Electronics, declares that this Monitor is in compliance with the essential requirements and other relevant provisions of Directive 1999/5/EC.
- The official Declaration of Conformity may be found at <http://www.samsung.com/displaysolutions>, go to Support > Search Product Support and enter the model name.
- This equipment may only be used indoors.
- This equipment may be operated in all EU countries.

**Recommendation - USA only**

- Dispose unwanted electronics through an approved recycler.
- To find the nearest recycling location, go to our website: [www.samsung.com/recyclingdirect](http://www.samsung.com/recyclingdirect) or call, (877) 278 - 0799

## Standard signal mode table

This product can be set to only one resolution for each screen size to obtain the optimum picture quality due to the nature of the panel. Using a resolution other than the specified resolution may degrade the picture quality. To avoid this, it is recommended that you select the optimum resolution specified for your product.

Check the frequency when you exchange a CDT product (connected to a PC) for an LCD product. If the LCD product does not support 85Hz, change the vertical frequency to 60Hz using the CDT product before you exchange it with the LCD product.

Model Name		PM32F / PM43F / PM49F / PM55F PH43F / PH49F / PH55F
Synchronization	Horizontal frequency	30 - 80 kHz
	Vertical frequency	60 - 75 Hz
Resolution	Optimum resolution	1920 x 1080 @ 60 Hz
	Maximum resolution	1920 x 1080 @ 60 Hz

- **Horizontal frequency**

The time required to scan a single line from the left to the right side of the screen is called a horizontal cycle. The reciprocal number of a horizontal cycle is called horizontal frequency. Horizontal frequency is measured in kHz.

- **Vertical frequency**

The product displays a single image multiple times per second (like a fluorescent light) to display what the viewer sees. The rate of a single image being displayed repeatedly per second is called vertical frequency or refresh rate. Vertical frequency is measured in Hz.

The screen will automatically be adjusted if a signal that belongs to the following standard signal modes is transmitted from your PC. If the signal transmitted from the PC does not belong to the standard signal modes, the screen may be blank with the power LED on. In such a case, change the settings according to the following table by referring to the graphics card user manual.

Resolution	Horizontal Frequency (kHz)	Vertical Frequency (Hz)	Pixel Clock (MHz)	Sync Polarity (H/V)
IBM, 720 x 400	31.469	70.087	28.322	-/+
MAC, 640 x 480	35.000	66.667	30.240	-/-
MAC, 832 x 624	49.726	74.551	57.284	-/-
MAC, 1152 x 870	68.681	75.062	100.000	-/-

Resolution	Horizontal Frequency (kHz)	Vertical Frequency (Hz)	Pixel Clock (MHz)	Sync Polarity (H/V)
VESA, 640 x 480	31.469	59.940	25.175	-/-
VESA, 640 x 480	37.861	72.809	31.500	-/-
VESA, 640 x 480	37.500	75.000	31.500	-/-
VESA, 800 x 600	35.156	56.250	36.000	+/+
VESA, 800 x 600	37.879	60.317	40.000	+/+
VESA, 800 x 600	48.077	72.188	50.000	+/+
VESA, 800 x 600	46.875	75.000	49.500	+/+
VESA, 1024 x 768	48.363	60.004	65.000	-/-
VESA, 1024 x 768	56.476	70.069	75.000	-/-
VESA, 1024 x 768	60.023	75.029	78.750	+/+
VESA, 1152 x 864	67.500	75.000	108.000	+/+
VESA, 1280 x 720	45.000	60.000	74.250	+/+
VESA, 1280 x 800	49.702	59.810	83.500	-/+
VESA, 1280 x 1024	63.981	60.020	108.000	+/+
VESA, 1280 x 1024	79.976	75.025	135.000	+/+
VESA, 1366 x 768	47.712	59.790	85.500	+/+
VESA, 1440 x 900	55.935	59.887	106.500	-/+
VESA, 1600 x 900	60.000	60.000	108.000	+/+
VESA, 1680 x 1050	65.290	59.954	146.250	-/+
VESA, 1920 x 1080	67.500	60.000	148.500	+/+

## Responsibility for the pay service (Cost to Customers)

When the service is requested, in spite of in warranty, we may charge you for a visit from a service technician in the following cases.

### Not a product defect

Cleaning of the product, Adjustment, Explanation, Re-installation and etc.

- If a service technician gives instructions on how to use product or simply adjusts options without disassembling product.
- If a defect is caused by external environmental factors (Internet, Antenna, Wired Signal, etc.)
- If a product is reinstalled or devices are connected additionally after installing the purchased product for the first time.
- If a product is reinstalled to move to a different spot or to move to a different house.
- If customer requests instructions on how to use because of another company's product.
- If customer requests instructions on how to use the network or another company's programme.
- If customer requests software installation and setup for the product.
- If a service technician removes/cleans dusts or foreign materials inside of the product.
- If customer requests an installation additionally after purchasing a product through homeshopping or online.

## A product damage caused by customer's fault

Product damage caused by customer's mishandling or wrong repair

If a product damage is caused by;

- External impact or drop.
- Use of supplies or separately sold product unspecified by Samsung.
- Repair from a person besides an engineer of outsourcing service company or partner of Samsung Electronics Co., Ltd.
- Remodeling or repairing the product by customer.
- Using it with incorrect voltage or non-authorized electrical connections.
- Not following the "cautions" in User Manual.

### Others

- If product fails by natural disaster. (lightning, fire, earthquake, flood damage, etc)
- If consumable components are all used up. (Battery, Toner, Fluorescent lights, Head, Vibrator, Lamp, Filter, Ribbon, etc.)

If customer requests a service in case the product has no defect, service fee may be charged. So please read User Manual first.

## Optimum picture quality and afterimage burn-in prevention

### Optimum picture quality

- Due to the nature of the manufacturing of this product, approximately 1 pixel per million (1ppm) may be brighter or darker on the panel. This does not affect product performance.
  - The number of sub-pixels by panel type: 6,220,800
- Run **Auto Adjustment** to improve the picture quality. If noise is still found even after auto adjustment, adjust **Coarse** or **Fine**.
- Leaving the screen fixed on a stationary image for an extended period of time may cause afterimage burn-in or defective pixels.
  - Activate power saving mode or a dynamic screen saver if you will not be using the product for an extended period of time.

### Prevention of afterimage burn-in

#### What is afterimage burn-in?

Afterimage burn-in should not occur when the LCD panel is operating normally. Normal operation refers to a continuously changing video pattern. If the LCD panel displays a fixed pattern for an extended period of time (more than 12 hours), a slight voltage difference may occur between the electrodes in pixels that control the liquid crystals.

Such a voltage difference between electrodes increases with time and makes the liquid crystals thinner. When this occurs, a previous image can remain on the screen when the pattern changes. To prevent this, the accumulated voltage difference should be reduced.

Afterimage burn-in should not occur when an LCD panel is operating in proper conditions.

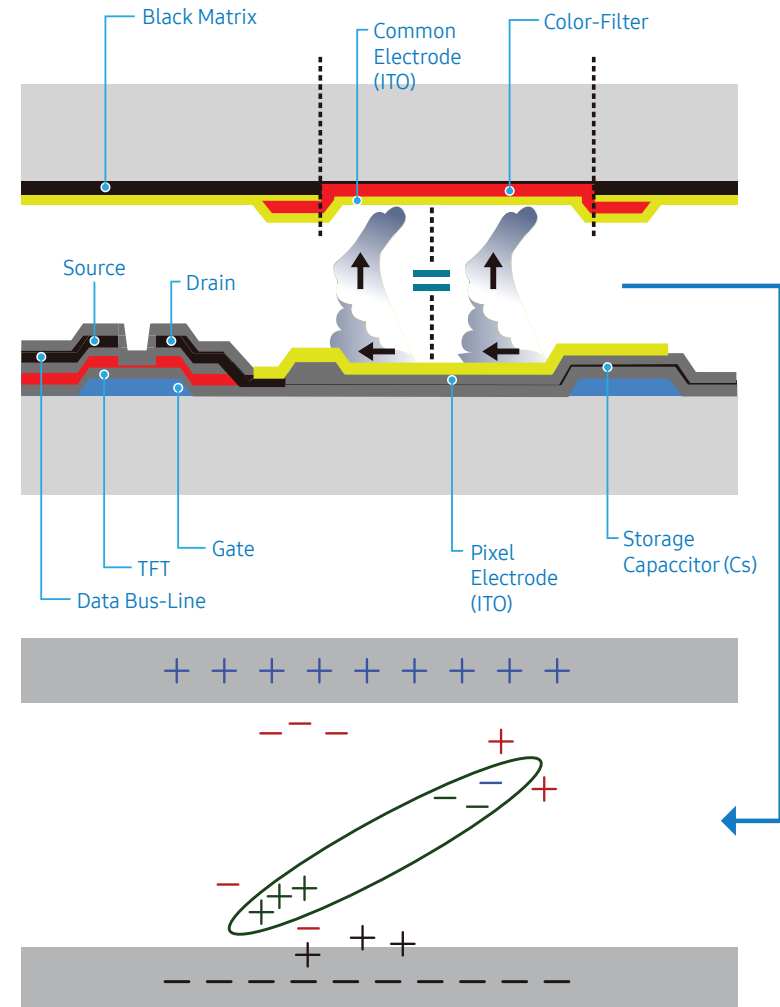

## Preventing afterimage burn-in

The best way to protect the product from afterimage burn-in is switching the power off or setting the PC or system to run a screen saver when not in use. Also, Warranty service may be limited depending on instruction guide.

- Powering Off, Screen Saver and Power Saving Mode
  - Power off the product for 2 hours after using it for 12 hours.
  - Go to Display Properties > Power Supply on your PC and set the product to power off as required.
  - Using a screen saver is recommended.  
It is best to use a single-color or moving-image screen saver.
- Regular color change
  - Use 2 colors.  
Switch between 2 colors every 30 minutes as shown above.

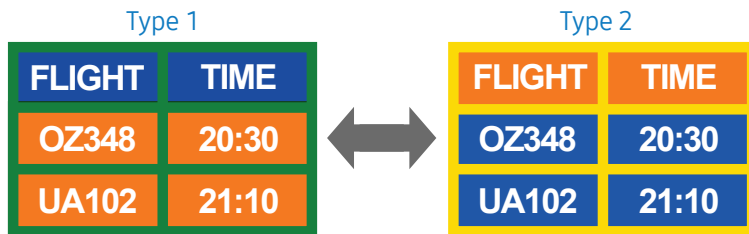

- Avoid combinations of a text color and background color of contrasting brightness. (Brightness: refers to the lightness or darkness of a color which varies depending on the amount of light emitted.)

- Avoid using grey as it may contribute to afterimage burn-in.
- Avoid using colors of contrasting brightness (black and white; grey).



- Regular Text color Change

- Use bright colors of similar brightness.  
Interval: Change text color and background color every 30 minutes.

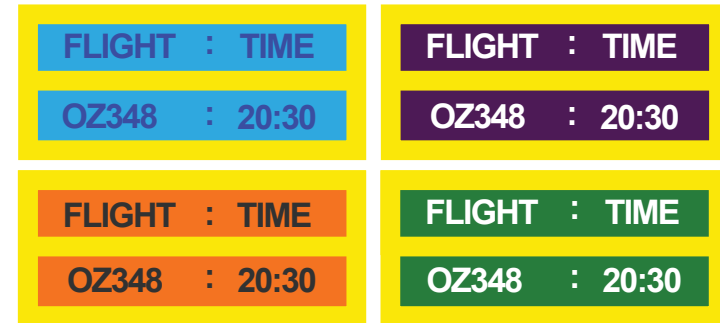



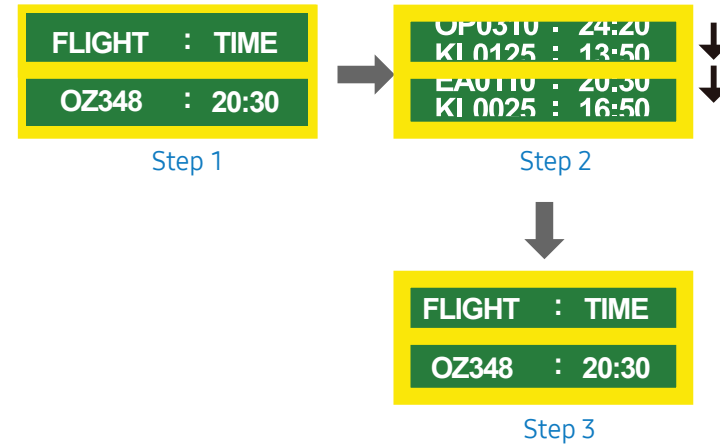

- Move and change text every 30 minutes as shown below.



- Regularly display a moving image along with a logo.  
Interval: Display a moving image along with a logo for 60 seconds after using for 4 hours.

## License

	Manufactured under licence from Dolby Laboratories. Dolby and the double-D symbol are trademarks of Dolby Laboratories.
	Manufactured under a licence from U.S. Patent No's: 5,956,674, 5,974,380, 5,978,762, 6,487,535, 6,226,616, 7,212,872, 7,003,467, 7,272,567, 7,668,723, 7,392,195, 7,930,184, 7,333,929 and 7,548,853. DTS, the Symbol, and DTS and the Symbol together are registered trademarks & DTS Premium Sound is a trademark of DTS, Inc. ©2012 DTS, Inc. All Rights Reserved.
	Manufactured under a license from U.S. Patent No's: 6,285,767, 8,027,477, 5,319,713, 5,333,201, 5,638,452, 5,771,295, 5,970,152, 5,912,976, 7,200,236, 7,492,907, 8,050,434, 7,720,240, 7,031,474, 7,907,736 and 7,764,802. DTS, the Symbol, and DTS and the Symbol together are registered trademarks & DTS Studio Sound is a trademark of DTS, Inc. ©2012 DTS, Inc. All Rights Reserved.
	The terms HDMI and HDMI High-Definition Multimedia Interface, and the HDMI Logo are trademarks or registered trademarks of HDMI Licensing LLC in the United States and other countries.



DivX Certified® to play DivX® video up to HD 1080p, including premium content.

DivX®, DivX Certified® and associated logos are trademarks of DivX, LLC and are used under license.

This DivX Certified® device has passed rigorous testing to ensure it plays DivX® video.

To play purchased DivX movies, first register your device at vod.divx.com. Find your registration code in the DivX VOD section of your device setup menu.

Covered by one or more of the following U.S. patents: 7,295,673; 7,460,668; 7,515,710; 8,656,183; 8,731,369; RE45,052.

This device supports DivX Plus Streaming® for enjoying HD movies and TV shows with advanced features (multi-language subtitles, multiple audio tracks, chapters, smooth FF/RW, etc.) streamed to your device.

### Open Source Licence Notice

In the case of using open source software, Open Source Licences are available on the product menu. Open Source Licence Notice is written only English.

For information on the Open Source Licence Notice, contact the Samsung Customer Center or send email to [oss.request@samsung.com](mailto:oss.request@samsung.com).